

lightnet

Highlighting
Architecture



Prices XXII

Update 11.2022



Stromschiene Track Rail	2
Tisch Table Table	11
Steh Floor Lampadaire	16
Wand Wall Applique	32
Pendel Suspended Suspension	52
Anbau Surface Apparent	118
Einbau Recessed Encastré	164
Höhere Schutzart Higher Protection Indice de Protection Supérieur	198
Appendix Appendix Annexe	204

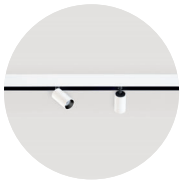

Midpin C2/C3 |
48V Track
4



Midpoint C6 |
3-Phase Track
5



Midpoint C7 |
3-Phase DALI Track
5



Basic Déco C3 |
3-Phase Track
6



Liquid Line Compact C5 |
3-Phase Track
7



Liquid Line CX | System
40mm 3-Phase Track
7



Cubic Evolution C4 |
3-Phase Track
8

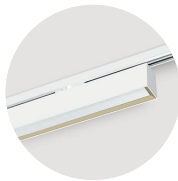

Matric Déco C9 |
System 55mm 3-Phase Track
9



3-Phase Track
10

Stromschiene | Track | Rail

Midpin C2/C3 | 48V Track

catalogue page 30



Midpin C2 Build-In Version



Midpin C3 Suspended Version

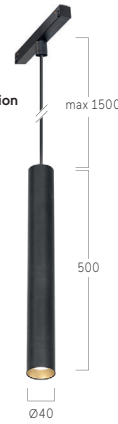

Midpin C2 Build-In Version

Beam Angle	Colour Temperature	Control	Power	Lumen/Watt	Weight kg	Code Snow White	Code Jet Black	CHF
Medium 30°	4000K	DALI	Medium	750lm/11W	0,8	DC2BWL-940M-W	DC2BBL-940M-B	352,00
Flood 40°	4000K	DALI	Medium	770lm/11W	0,8	DC2CWL-940M-W	DC2CBL-940M-B	352,00

Midpin C3 Build-In Version

Medium 30°	4000K	DALI	Medium	750lm/11W	1,0	DC3BWL-940M-W	DC3BBL-940M-B	363,00
Flood 40°	4000K	DALI	Medium	770lm/11W	1,0	DC3CWL-940M-W	DC3CBL-940M-B	363,00

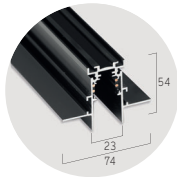

Recessed Track:

L mm	Code Black	Weight kg	CHF
2000	X-LV-TRACK-L2000-L-B	3,6	305,00

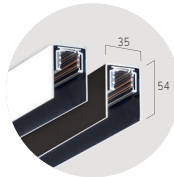

Surface Track:

Code Black	Code White	Weight kg	CHF
X-LV-TRACK-Lxxx-A-B	X-LV-TRACK-Lxxx-A-W	1,4	ⓘ

DE 48V-Converter können wahlweise in Surface-Track integriert werden oder alternativ in einer separaten Box platziert werden. Auf Grundlage skizzierter Kundenvorgabe erstellt Lightnet eine technische Zeichnung der gewünschten Struktur zur Prüfung und Freigabe. Wahlweise auch als abgehängte Struktur möglich. Stirnseiten inklusive. Profil-Innenseite schwarz. Profil-Außenseite weiß, schwarz oder in Sonderfarbe auf Anfrage.

EN 48V converters can either be integrated into Surface Track or be placed in a separate box. Based on customer specifications, Lightnet creates a technical drawing of the desired structure for review and approval. Optionally also available as suspended version. End caps included. Interior profile black. Exterior profile white, black or special colour upon request.



Straight Mechanical Connector:

Code Black	CHF
X-LV-CONNECTOR-B	18,00



Feed:

Code Black	CHF
X-LV-FEED-B	46,00



Straight Electrical Connector:

Code Black	CHF
X-LV-SCOUPLER-B	37,00



End Cap Recessed:

Code Black	CHF
X-LV-CAP-L-B [RECESSED]	20,00



Corner Connector:

Code Black	CHF
X-LV-LCOUPLER-B	116,00



Installation Set for Recessed Track:

L mm	Code Black	CHF
1,5M	X-LV-SUSP-1500-B	34,00
4M	X-LV-SUSP-4000-B	34,00



48V-Converter:

Power	Code	CHF
100W	X-LV-CONVERTER-100W-E	289,00
150W	X-LV-CONVERTER-150W-E	298,00

Surcharges

Surface / Reflector Finish

W: Snow White	✓
V: Ivory White	✓
S: Radiant Silver	✓
B: Jet Black	✓
H: Anodic Champagne	+10%
R: Special RAL/NCS Colours	ⓘ

Colour Temperature

27: 2700K	+5%
30: 3000K	✓
35: 3500K	+5%
40: 4000K	✓
DW: Dim to Warm 3000K-1800K	+15%

Optic Ring

W: Snow White	✓
V: Ivory White	✓
A: Satin Silver	✓
B: Jet Black	✓
H: Anodic Champagne	✓
K: Satin Copper	✓
G: Satin Gold	✓

✓ standard / no extra charge ⓘ on request ✗ not available

Midpoint C6 | 3-Phase Track

catalogue page 34



Led Engine - Eco:

Beam Angle	Colour Temperature	Control	Power	Lumen/Watt	Weight kg	Code Snow White	Code Radiant Silver	CHF
Spot 10°	4000K	On/Off	Low	1440lm/19W	1,1	PC6AWE-940FE-WKG	PC6ASE-940FE-SKG	368,00
Spot 10°	4000K	On/Off	Medium	2020lm/31W	1,1	PC6AWE-940FM-WKG	PC6ASE-940FM-SKG	368,00
Medium 20°	4000K	On/Off	Low	1850lm/19W	1,1	PC6BWE-940FE-WKG	PC6BSE-940FE-SKG	345,00
Medium 20°	4000K	On/Off	Medium	2870lm/31W	1,1	PC6BWE-940FM-WKG	PC6BSE-940FM-SKG	345,00
Flood 35°	4000K	On/Off	Low	1790lm/19W	1,1	PC6CWE-940FE-WKG	PC6CSE-940FE-SKG	345,00
Flood 35°	4000K	On/Off	Medium	2780lm/31W	1,1	PC6CWE-940FM-WKG	PC6CSE-940FM-SKG	345,00
W Flood 50°	4000K	On/Off	Low	1680lm/19W	1,1	PC6DWE-940FE-WKG	PC6DSE-940FE-SKG	345,00
W Flood 50°	4000K	On/Off	Medium	2710lm/31W	1,1	PC6DWE-940FM-WKG	PC6DSE-940FM-SKG	345,00

Led Engine - Artist Xicato:

Beam Angle	Colour Temperature	Control	Power	Lumen/Watt	Weight kg	Code Snow White	Code Radiant Silver	CHF
Spot 10°	4000K	On/Off	Low	1190lm/19W	1,1	PC6AWE-940AE-WKG	PC6ASE-940AE-SKG	482,00
Spot 10°	4000K	On/Off	Medium	1560lm/31W	1,1	PC6AWE-940AM-WKG	PC6ASE-940AM-SKG	482,00
Medium 20°	4000K	On/Off	Low	1510lm/19W	1,1	PC6BWE-940AE-WKG	PC6BSE-940AE-SKG	445,00
Medium 20°	4000K	On/Off	Medium	2220lm/31W	1,1	PC6BWE-940AM-WKG	PC6BSE-940AM-SKG	445,00
Flood 35°	4000K	On/Off	Low	1470lm/19W	1,1	PC6CWE-940AE-WKG	PC6CSE-940AE-SKG	445,00
Flood 35°	4000K	On/Off	Medium	2160lm/31W	1,1	PC6CWE-940AM-WKG	PC6CSE-940AM-SKG	445,00
W Flood 50°	4000K	On/Off	Low	1430lm/19W	1,1	PC6DWE-940AE-WKG	PC6DSE-940AE-SKG	445,00
W Flood 50°	4000K	On/Off	Medium	2140lm/31W	1,1	PC6DWE-940AM-WKG	PC6DSE-940AM-SKG	445,00

Surcharges

Surface / Reflector Finish	CHF	Colour Temperature	CHF	Optic Ring	CHF	Cover	CHF	Adaptor	CHF
W: Snow White	✓	27: 2700K	+5%	W: Snow White	✓	K: Clear Cover	✓	G: Global Adaptor	✓
V: Ivory White	✓	30: 3000K	✓	V: Ivory White	✓	P: Prismatic Lens	+21,00	E: Eutrac Adaptor	+14,00
S: Radiant Silver	✓	40: 4000K	✓	S: Radiant Silver	✓	H: Honeycomb Louvre	+21,00		
B: Jet Black	✓			B: Jet Black	✓			Additional Options	CHF
H: Anodic Champagne	+10%			H: Anodic Champagne	✓			Optic Removal Tool	34,00
R: Special RAL/NCS Colours	🔴			K: Satin Copper	✓				
				G: Satin Gold	✓				

✓ standard / no extra charge 🔴 on request ✗ not available

Midpoint C7 | 3-Phase DALI Track

catalogue page 36



Led Engine - Eco:

Beam Angle	Colour Temperature	Control	Power	Lumen/Watt	Weight kg	Code Snow White	Code Radiant Silver	CHF
Spot 10°	4000K	DALI	Low	1440lm/19W	1,3	PC7AWL-940FE-WKG	PC7ASL-940FE-SKG	517,00
Spot 10°	4000K	DALI	Medium	2020lm/31W	1,3	PC7AWL-940FM-WKG	PC7ASL-940FM-SKG	517,00
Medium 20°	4000K	DALI	Low	1850lm/19W	1,3	PC7BWL-940FE-WKG	PC7BSL-940FE-SKG	492,00
Medium 20°	4000K	DALI	Medium	2870lm/31W	1,3	PC7BWL-940FM-WKG	PC7BSL-940FM-SKG	492,00
Flood 35°	4000K	DALI	Low	1790lm/19W	1,3	PC7CWL-940FE-WKG	PC7CSL-940FE-SKG	492,00
Flood 35°	4000K	DALI	Medium	2780lm/31W	1,3	PC7CWL-940FM-WKG	PC7CSL-940FM-SKG	492,00
W Flood 50°	4000K	DALI	Low	1680lm/19W	1,3	PC7DWL-940FE-WKG	PC7DSL-940FE-SKG	492,00
W Flood 50°	4000K	DALI	Medium	2710lm/31W	1,3	PC7DWL-940FM-WKG	PC7DSL-940FM-SKG	492,00

... Midpoint 3-Phase DALI Track | C7

Led Engine - Artist Xicato:	Beam Angle	Colour Temperature	Control	Power	Lumen/Watt	Weight kg	Code Snow White	Code Radiant Silver	CHF
	Spot 10°	4000K	DALI	Low	1190lm/19W	1,3	PC7AWL-940AE-WKG	PC7ASL-940AE-SKG	630,00
	Spot 10°	4000K	DALI	Medium	1560lm/31W	1,3	PC7AWL-940AM-WKG	PC7ASL-940AM-SKG	630,00
	Medium 20°	4000K	DALI	Low	1510lm/19W	1,3	PC7BWL-940AE-WKG	PC7BSL-940AE-SKG	594,00
	Medium 20°	4000K	DALI	Medium	2220lm/31W	1,3	PC7BWL-940AM-WKG	PC7BSL-940AM-SKG	594,00
	Flood 35°	4000K	DALI	Low	1470lm/19W	1,3	PC7CWL-940AE-WKG	PC7CSL-940AE-SKG	594,00
	Flood 35°	4000K	DALI	Medium	2160lm/31W	1,3	PC7CWL-940AM-WKG	PC7CSL-940AM-SKG	594,00
	W Flood 50°	4000K	DALI	Low	1430lm/19W	1,3	PC7DWL-940AE-WKG	PC7DSL-940AE-SKG	594,00
	W Flood 50°	4000K	DALI	Medium	2140lm/31W	1,3	PC7DWL-940AM-WKG	PC7DSL-940AM-SKG	594,00

Surcharges

Surface / Reflector Finish	CHF	Colour Temperature	CHF	Optic Ring	CHF	Cover	CHF	Adaptor	CHF
W: Snow White	✓	27: 2700K	+5%	W: Snow White	✓	K: Clear Cover	✓	G: Global Adaptor	✓
V: Ivory White	✓	30: 3000K	✓	V: Ivory White	✓	P: Prismatic Lens	+21,00	E: Eutrac Adaptor	+14,00
S: Radiant Silver	✓	40: 4000K	✓	S: Radiant Silver	✓	H: Honeycomb Louvre	+21,00		
B: Jet Black	✓			B: Jet Black	✓			Additional Options	CHF
H: Anodic Champagne	+10%			H: Anodic Champagne	✓			Optic Removal Tool	34,00
R: Special RAL/NCS Colours	🔴			G: Satin Gold	✓				
				K: Satin Copper	✓				

✓ standard / no extra charge 🔴 on request ✗ not available

Basic Déco C3 | 3-Phase Track

catalogue page 38

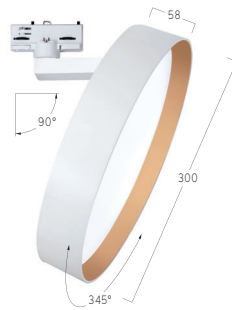

Microprismatic | Direct

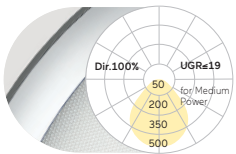

D mm	Colour Temperature	Control	Power	Lumen/Watt	Weight kg	Code Snow White	Code Radiant Silver	CHF
300	4000K	On/Off	Medium	830lm/8W	3,0	BC3AWE-840M-D300-GW	BC3ASE-840M-D300-GS	872,00
300	4000K	On/Off	High	1430lm/13W	3,0	BC3AWE-840H-D300-GW	BC3ASE-840H-D300-GS	872,00

Opal Diffuser | Direct

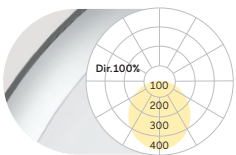

D mm	Colour Temperature	Control	Power	Lumen/Watt	Weight kg	Code Snow White	Code Radiant Silver	CHF
300	4000K	On/Off	Medium	810lm/8W	3,0	BC3OWE-840M-D300-GW	BC3OSE-840M-D300-GS	853,00
300	4000K	On/Off	High	1400lm/13W	3,0	BC3OWE-840H-D300-GW	BC3OSE-840H-D300-GS	853,00

Surcharges

Surface / Reflector Finish	CHF	Surface / Reflector Finish	CHF	Control Gear	CHF	Colour Temperature	CHF
Uni-Colours		Dual Colours		E: On/Off	✓	22: 2200K	+5%
W...W: Snow White / Snow White	✓	W...G: Snow White / Satin Gold	+15%	L: DALI	+86,00	27: 2700K	+5%
V...V: Ivory White / Ivory White	✓	W...K: Snow White / Satin Copper	+15%			30: 3000K	✓
S...S: Radiant Silver / Radiant Silver	✓	W...B: Snow White / Jet Black	+15%	Colour Rendering	CHF	35: 3500K	+5%
U...U: Urban Graphite / Urban Graphite	✓	H...B: Anodic Champagne / Jet Black	+15%	8: CRI>80	✓	40: 4000K	✓
B...B: Jet Black / Jet Black	✓	B...G: Jet Black / Satin Gold	+15%	9: CRI>90	+5%	65: 6500K	+5%
H...H: Anodic Champ. / Anodic Champ.	+15%	B...W: Jet Black / Snow White	+15%	F: Full Spectrum	+15%	Adaptor	CHF
K...K: Satin Copper / Satin Copper	+15%					G: Global Adaptor	✓
						E: Eutrac Adaptor	+10%

✓ standard / no extra charge 🔴 on request ✗ not available

Liquid Line Compact C5 | 3-Phase Track

catalogue page 40

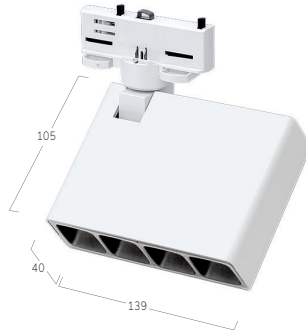

Lens Louvre | Direct

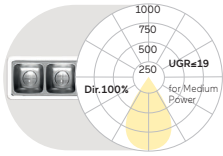

L mm	Colour Temperature	Control	Power	Lumen/Watt	Weight kg	Code Snow White/Jet Black	Code Jet Black/Jet Black	CHF
139	4000K	On/Off	Medium	620lm/7W	0,9	QC5LWE-840M-L139-GB*	QC5LBE-840M-L139-GB*	541,00
139	4000K	On/Off	High	820lm/9W	0,9	QC5LWE-840H-L139-GB*	QC5LBE-840H-L139-GB*	541,00

Opal Diffuser | Direct

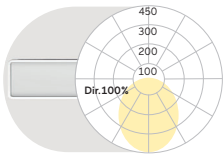

L mm	Colour Temperature	Control	Power	Lumen/Watt	Weight kg	Code Snow White	Code Jet Black	CHF
139	4000K	On/Off	Medium	530lm/7W	0,9	QC5OWE-840M-L139-G	QC5OBE-840M-L139-G	489,00
139	4000K	On/Off	High	720lm/9W	0,9	QC5OWE-840H-L139-G	QC5OBE-840H-L139-G	489,00

Surcharges

Surface	CHF	Control Gear	CHF	Colour Temperature	CHF	Lens Louvre*	CHF	Adaptor	CHF
W: Snow White	✓	E: On/Off	✓	22: 2200K	+5%	W: Snow White	✓	G: Global Adaptor	✓
V: Ivory White	✓	L: DALI	+49,00	27: 2700K	+5%	A: Satin Silver	✓	E: Eutrac Adaptor	+14,00
A: Satin Silver	+15%			30: 3000K	✓	B: Jet Black	✓		
S: Radiant Silver	✓	Colour Rendering	CHF	35: 3500K	+5%	H: Anodic Champagne	✓		
U: Urban Graphite	✓	8: CRI>80	✓	40: 4000K	✓	K: Satin Copper	✓		
B: Jet Black	✓	9: CRI>90	+5%	65: 6500K	+5%	G: Satin Gold	✓		
H: Anodic Champagne	+10%	F: Full Spectrum	+15%						
K: Satin Copper	+15%								
R: Special RAL/NCS Colours	🕒								

✓ standard / no extra charge
 🕒 on request
 ✗ not available

Liquid Line CX | System 40 mm 3-Phase Track

catalogue page 42



Lens Louvre | Direct

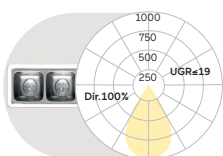

L mm	Colour Temperature	Control	Power	Lumen/Watt	Weight kg	Code Snow White/Jet Black	Code Jet Black/Jet Black	CHF
668	4000K	On/Off	Low	1090lm/10W	1,7	QCXLWE-840E-L668-GB*	QCXLBE-840E-L668-GB*	664,00
668	4000K	On/Off	High	2000lm/17W	1,7	QCXLWE-840H-L668-GB*	QCXLBE-840H-L668-GB*	664,00
932	4000K	On/Off	Low	1520lm/13W	2,2	QCXLWE-840E-L932-GB*	QCXLBE-840E-L932-GB*	699,00
932	4000K	On/Off	High	2790lm/24W	2,2	QCXLWE-840H-L932-GB*	QCXLBE-840H-L932-GB*	699,00
1197	4000K	On/Off	Low	1960lm/16W	2,6	QCXLWE-840E-L1197-GB*	QCXLBE-840E-L1197-GB*	751,00
1197	4000K	On/Off	High	3590lm/30W	2,6	QCXLWE-840H-L1197-GB*	QCXLBE-840H-L1197-GB*	751,00
1461	4000K	On/Off	Low	2390lm/19W	3,0	QCXLWE-840E-L1461-GB*	QCXLBE-840E-L1461-GB*	874,00
1461	4000K	On/Off	High	4390lm/37W	3,0	QCXLWE-840H-L1461-GB*	QCXLBE-840H-L1461-GB*	874,00
1726	4000K	On/Off	Low	2830lm/23W	3,5	QCXLWE-840E-L1726-GB*	QCXLBE-840E-L1726-GB*	1042,00
1726	4000K	On/Off	High	5190lm/43W	3,5	QCXLWE-840H-L1726-GB*	QCXLBE-840H-L1726-GB*	1042,00
1990	4000K	On/Off	Low	3260lm/26W	4,3	QCXLWE-840E-L1990-GB*	QCXLBE-840E-L1990-GB*	1243,00
1990	4000K	On/Off	High	5990lm/49W	4,3	QCXLWE-840H-L1990-GB*	QCXLBE-840H-L1990-GB*	1243,00

... Liquid Line CX | System 40mm 3-Phase Track

Opal Diffuser | Direct

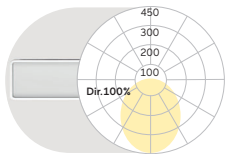

L mm	Colour Temperature	Control	Power	Lumen/Watt	Weight kg	Code Snow White	Code Jet Black	CHF
600	4000K	On/Off	Medium	870lm/9W	1,5	QCXOWE-840M-L600-G	QCXOBS-840M-L600-G	487,00
600	4000K	On/Off	High	1180lm/12W	1,5	QCXOWE-840H-L600-G	QCXOBS-840H-L600-G	487,00
890	4000K	On/Off	Medium	1300lm/12W	2,0	QCXOWE-840M-L890-G	QCXOBS-840M-L890-G	525,00
890	4000K	On/Off	High	1760lm/16W	2,0	QCXOWE-840H-L890-G	QCXOBS-840H-L890-G	525,00
1182	4000K	On/Off	Medium	1730lm/15W	2,5	QCXOWE-840M-L1182-G	QCXOBS-840M-L1182-G	555,00
1182	4000K	On/Off	High	2350lm/21W	2,5	QCXOWE-840H-L1182-G	QCXOBS-840H-L1182-G	555,00
1475	4000K	On/Off	Medium	2160lm/19W	3,0	QCXOWE-840M-L1475-G	QCXOBS-840M-L1475-G	623,00
1475	4000K	On/Off	High	2940lm/25W	3,0	QCXOWE-840H-L1475-G	QCXOBS-840H-L1475-G	623,00
1765	4000K	On/Off	Medium	2600lm/22W	3,5	QCXOWE-840M-L1765-G	QCXOBS-840M-L1765-G	741,00
1765	4000K	On/Off	High	3530lm/30W	3,5	QCXOWE-840H-L1765-G	QCXOBS-840H-L1765-G	741,00
2055	4000K	On/Off	Medium	3030lm/28W	4,3	QCXOWE-840M-L2055-G	QCXOBS-840M-L2055-G	889,00
2055	4000K	On/Off	High	4110lm/37W	4,3	QCXOWE-840H-L2055-G	QCXOBS-840H-L2055-G	889,00

Surcharges

Surface	CHF	Control Gear	CHF	CHF	Colour Temperature	CHF	Lens Louvre*	CHF	Adaptor	CHF
W: Snow White	✓	E: On/Off	✓	✓	22: 2200K	+5%	W: Snow White	✓	G: Global Adaptor	✓
V: Ivory White	✓	L: DALI	+86,00	+172,00	27: 2700K	+5%	A: Satin Silver	✓	E: Eutrac Adaptor	+14,00
A: Satin Silver	+15%	Colour Rendering	CHF		30: 3000K	✓	G: Satin Gold	✓	Additional Options	CHF
S: Radiant Silver	✓	8: CRI>80	✓		35: 3500K	+5%	B: Jet Black	✓	Midpin Spotlight XM	+363,00
U: Urban Graphite	✓	9: CRI>90	+5%		40: 4000K	✓	H: Anodic Champagne	✓		
B: Jet Black	✓	F: Full Spectrum	+15%		65: 6500K	+5%	K: Satin Copper	✓		
H: Anodic Champagne	+10%									
K: Satin Copper	+15%									
R: Special RAL/NCS Colours	🕒									

✓ standard / no extra charge
 🕒 on request
 ✗ not available

Cubic Evolution C4 | 3-Phase Track

catalogue page 44

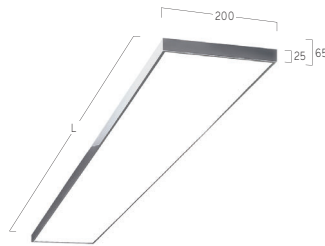

Microprismatic | Direct

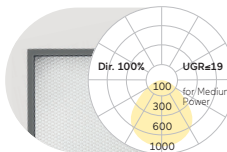

L mm	Colour Temperature	Control	Power	Lumen/Watt	Weight kg	Code Snow White	Code Silver Anodised	CHF
900	4000K	On/Off	Medium	2280lm/21W	5,4	CC4AWE-840M-L900-G	CC4AEE-840M-L900-G	833,00
900	4000K	On/Off	High	2930lm/26W	5,4	CC4AWE-840H-L900-G	CC4AEE-840H-L900-G	833,00
1200	4000K	On/Off	Medium	3050lm/27W	6,2	CC4AWE-840M-L1200-G	CC4AEE-840M-L1200-G	872,00
1200	4000K	On/Off	High	3900lm/34W	6,2	CC4AWE-840H-L1200-G	CC4AEE-840H-L1200-G	872,00
1500	4000K	On/Off	Medium	3700lm/32W	7,7	CC4AWE-840M-L1500-G	CC4AEE-840M-L1500-G	1019,00
1500	4000K	On/Off	High	4880lm/43W	7,7	CC4AWE-840H-L1500-G	CC4AEE-840H-L1500-G	1019,00

Opal Diffuser | Direct

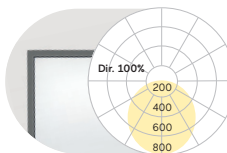

L mm	Colour Temperature	Control	Power	Lumen/Watt	Weight kg	Code Snow White	Code Silver Anodised	CHF
900	4000K	On/Off	Medium	2170lm/21W	5,4	CC4OWE-840M-L900-G	CC4OEE-840M-L900-G	816,00
900	4000K	On/Off	High	2730lm/26W	5,4	CC4OWE-840H-L900-G	CC4OEE-840H-L900-G	816,00
1200	4000K	On/Off	Medium	2890lm/27W	6,2	CC4OWE-840M-L1200-G	CC4OEE-840M-L1200-G	853,00
1200	4000K	On/Off	High	3650lm/34W	6,2	CC4OWE-840H-L1200-G	CC4OEE-840H-L1200-G	853,00
1500	4000K	On/Off	Medium	3460lm/32W	7,7	CC4OWE-840M-L1500-G	CC4OEE-840M-L1500-G	982,00
1500	4000K	On/Off	High	4560lm/43W	7,7	CC4OWE-840H-L1500-G	CC4OEE-840H-L1500-G	982,00

Surcharges

Surface Finish	CHF	Control Gear	CHF	Colour Rendering	CHF	Colour Temperature	CHF	Adaptor	CHF
W: Snow White	✓	E: On/Off	✓	8: CRI>80	✓	22: 2200K	+5%	G: Global Adaptor	✓
E: Silver Anodised	✓	L: DALI	+86,00	9: CRI>90	+5%	27: 2700K	+5%	E: Eutrac Adaptor	+14,00
U: Urban Graphite	✓			F: Full Spectrum	+15%	30: 3000K	✓	Additional Options	CHF
B: Jet Black	✓					35: 3500K	+5%	Multisensor	+261,00
H: Anodic Champagne	+10%					40: 4000K	✓		
R: Special RAL/NCS Colours	🕒					65: 6500K	+5%		

✓ standard / no extra charge
 🕒 on request
 ✗ not available

Matric Déco C9 | System 55mm 3-Phase Track

catalogue page 46

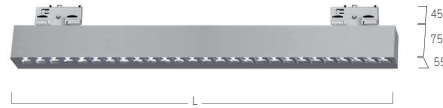

Lens Louvre | Direct

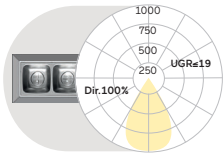

L mm	Colour Temperature	Control	Power	Lumen/Watt	Weight kg	Code Snow White/Snow White	Code Jet Black/Jet Black	CHF
681	4000K	On/Off	Low	1090lm/10W	2,2	LC9LWE-840E-L681-GW*	LC9LBE-840E-L681-GB*	692,00
681	4000K	On/Off	High	2000lm/17W	2,2	LC9LWE-840H-L681-GW*	LC9LBE-840H-L681-GB*	692,00
945	4000K	On/Off	Low	1520lm/13W	2,9	LC9LWE-840E-L945-GW*	LC9LBE-840E-L945-GB*	716,00
945	4000K	On/Off	High	2790lm/24W	2,9	LC9LWE-840H-L945-GW*	LC9LBE-840H-L945-GB*	716,00
1209	4000K	On/Off	Low	1960lm/16W	3,5	LC9LWE-840E-L1209-GW*	LC9LBE-840E-L1209-GB*	821,00
1209	4000K	On/Off	High	3590lm/30W	3,5	LC9LWE-840H-L1209-GW*	LC9LBE-840H-L1209-GB*	821,00
1474	4000K	On/Off	Low	2390lm/19W	4,1	LC9LWE-840E-L1474-GW*	LC9LBE-840E-L1474-GB*	972,00
1474	4000K	On/Off	High	4390lm/37W	4,1	LC9LWE-840H-L1474-GW*	LC9LBE-840H-L1474-GB*	972,00
1738	4000K	On/Off	Low	2830lm/23W	4,8	LC9LWE-840E-L1738-GW*	LC9LBE-840E-L1738-GB*	1164,00
1738	4000K	On/Off	High	5190lm/43W	4,8	LC9LWE-840H-L1738-GW*	LC9LBE-840H-L1738-GB*	1164,00
2002	4000K	On/Off	Low	3260lm/26W	5,7	LC9LWE-840E-L2002-GW*	LC9LBE-840E-L2002-GB*	1400,00
2002	4000K	On/Off	High	5990lm/49W	5,7	LC9LWE-840H-L2002-GW*	LC9LBE-840H-L2002-GB*	1400,00

Microprismatic | Direct

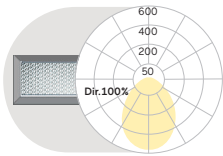

L mm	Colour Temperature	Control	Power	Lumen/Watt	Weight kg	Code Snow White/Snow White	Code Jet Black/Jet Black	CHF
600	4000K	On/Off	Low	550lm/7W	1,9	LC9AWE-840E-L600-GW	LC9ABE-840E-L600-GB	552,00
600	4000K	On/Off	High	990lm/12W	1,9	LC9AWE-840H-L600-GW	LC9ABE-840H-L600-GB	552,00
890	4000K	On/Off	Low	830lm/10W	2,6	LC9AWE-840E-L890-GW	LC9ABE-840E-L890-GB	576,00
890	4000K	On/Off	High	1490lm/16W	2,6	LC9AWE-840H-L890-GW	LC9ABE-840H-L890-GB	576,00
1182	4000K	On/Off	Low	1110lm/12W	3,2	LC9AWE-840E-L1182-GW	LC9ABE-840E-L1182-GB	629,00
1182	4000K	On/Off	High	1990lm/21W	3,2	LC9AWE-840H-L1182-GW	LC9ABE-840H-L1182-GB	629,00
1475	4000K	On/Off	Low	1390lm/14W	3,9	LC9AWE-840E-L1475-GW	LC9ABE-840E-L1475-GB	727,00
1475	4000K	On/Off	High	2480lm/25W	3,9	LC9AWE-840H-L1475-GW	LC9ABE-840H-L1475-GB	727,00
1765	4000K	On/Off	Low	1660lm/17W	4,6	LC9AWE-840E-L1765-GW	LC9ABE-840E-L1765-GB	884,00
1765	4000K	On/Off	High	2980lm/30W	4,6	LC9AWE-840H-L1765-GW	LC9ABE-840H-L1765-GB	884,00
2055	4000K	On/Off	Low	1940lm/22W	5,5	LC9AWE-840E-L2055-GW	LC9ABE-840E-L2055-GB	1084,00
2055	4000K	On/Off	High	3480lm/37W	5,5	LC9AWE-840H-L2055-GW	LC9ABE-840H-L2055-GB	1084,00

Opal Diffuser | Direct

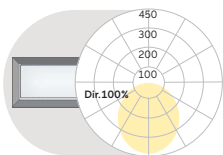

L mm	Colour Temperature	Control	Power	Lumen/Watt	Weight kg	Code Snow White/Snow White	Code Jet Black/Jet Black	CHF
600	4000K	On/Off	Medium	780lm/9W	1,9	LC9OWE-840M-L600-GW	LC9OBE-840M-L600-GB	534,00
600	4000K	On/Off	High	1060lm/12W	1,9	LC9OWE-840H-L600-GW	LC9OBE-840H-L600-GB	534,00
890	4000K	On/Off	Medium	1170lm/12W	2,6	LC9OWE-840M-L890-GW	LC9OBE-840M-L890-GB	559,00
890	4000K	On/Off	High	1590lm/16W	2,6	LC9OWE-840H-L890-GW	LC9OBE-840H-L890-GB	559,00
1182	4000K	On/Off	Medium	1560lm/15W	3,2	LC9OWE-840M-L1182-GW	LC9OBE-840M-L1182-GB	604,00
1182	4000K	On/Off	High	2110lm/21W	3,2	LC9OWE-840H-L1182-GW	LC9OBE-840H-L1182-GB	604,00
1475	4000K	On/Off	Medium	1950lm/19W	3,9	LC9OWE-840M-L1475-GW	LC9OBE-840M-L1475-GB	692,00
1475	4000K	On/Off	High	2640lm/25W	3,9	LC9OWE-840H-L1475-GW	LC9OBE-840H-L1475-GB	692,00
1765	4000K	On/Off	Medium	2330lm/22W	4,6	LC9OWE-840M-L1765-GW	LC9OBE-840M-L1765-GB	839,00
1765	4000K	On/Off	High	3170lm/30W	4,6	LC9OWE-840H-L1765-GW	LC9OBE-840H-L1765-GB	839,00
2055	4000K	On/Off	Medium	2720lm/28W	5,5	LC9OWE-840M-L2055-GW	LC9OBE-840M-L2055-GB	1014,00
2055	4000K	On/Off	High	3700lm/37W	5,5	LC9OWE-840H-L2055-GW	LC9OBE-840H-L2055-GB	1014,00

Surcharges

Surface / Reflector Finish + Lens Louvre*

Uni-Colours

W...W: Snow White / Snow White	✓
V...V: Ivory White / Ivory White	✓
A...A: Satin Silver / Satin Silver	✓
U...U: Urban Graphite / Urban Graphite	✓
B...B: Jet Black / Jet Black	✓
H...H: Anodic Champ. / Anodic Champ.	+10%
K...K: Satin Copper / Satin Copper	+15%

Surface / Reflector Finish + Lens Louvre*

Dual Colours

W...G: Snow White / Satin Gold	+15%
W...K: Snow White / Satin Copper	+15%
W...B: Snow White / Jet Black	+15%
H...B: Anodic Champagne / Jet Black	+15%
B...G: Jet Black / Satin Gold	+15%
B...W: Jet Black / Snow White	+15%

Control Gear

Control Gear	CHF	CHF
	L890-L1765	L2055
E: On/Off	✓	✓
L: DALI	+86,00	+172,00

Colour Rendering

Colour Rendering	CHF
8: CRI>80	✓
9: CRI>90	+5%
F: Full Spectrum	+15%

Colour Temperature

Colour Temperature	CHF
22: 2200K	+5%
27: 2700K	+5%
30: 3000K	✓
35: 3500K	+5%
40: 4000K	✓
65: 6500K	+5%

Adaptor	CHF
G: Global Adaptor	✓
E: Eutrac Adaptor	+14,00

✓ standard / no extra charge ⚡ on request ✗ not available

3-Phase Tracs

catalogue page 48



Track Surface (for Global Adaptor):

L mm	Type	Control	Weight kg	Code Black	Code White	CHF
2000	Surface Mounted	On/Off	3,4	X-HV-TRACK-L2000-E-A-B	X-HV-TRACK-L2000-E-A-W	109,00
2000	Surface Mounted	DALI	3,4	X-HV-TRACK-L2000-L-A-B	X-HV-TRACK-L2000-L-A-W	109,00

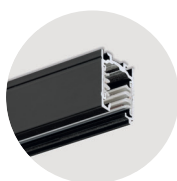

Track Recessed (for Global Adaptor):

L mm	Type	Control	Weight kg	Code Black	Code White	CHF
2000	Recessed Mounted	On/Off	3,2	X-HV-TRACK-L2000-E-L-B	X-HV-TRACK-L2000-E-L-W	156,00
2000	Recessed Mounted	DALI	3,2	X-HV-TRACK-L2000-L-L-B	X-HV-TRACK-L2000-L-L-W	156,00

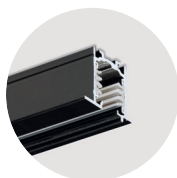

Feed:

Type	Code Black	Code White	CHF
Right	X-HV-RFEED-B	X-HV-RFEED-W	27,00
Left	X-HV-LFEED-B	X-HV-LFEED-W	27,00



Straight Connector:

Code Black	Code White	CHF
X-HV-SCOUPLER-B	X-HV-SCOUPLER-W	20,00



Corner Connector:

Type	Code Black	Code White	CHF
Internal Earth	X-HV-LICOUPLER-B	X-HV-LICOUPLER-W	62,00
External Earth	X-HV-LECOUPLER-B	X-HV-LECOUPLER-W	62,00



Flex Connector:

Code Black	Code White	CHF
X-HV-FLEXCOUPLER-B	X-HV-FLEXCOUPLER-W	88,00



End Cap Surface:

Type	Code Black	Code White	CHF
Surface Mounted	X-HV-CAP-A-B	X-HV-CAP-A-W	4,00



End Cap Recessed:

Type	Code Black	Code White	CHF
Recessed Mounted	X-HV-CAP-L-B	X-HV-CAP-L-W	4,00



Suspension Set:

L mm	Code Black	Code White	CHF
1,5M	X-HV-SUSPENSION-1500-B	X-HV-SUSPENSION-1500-W	34,00
4M	X-HV-SUSPENSION-4000-B	X-HV-SUSPENSION-4000-W	34,00





Lucille T1 |
Table
12



Beam Me Up T1 |
Mini Table Office
12



Beam Me Up T2 |
Mini Table Home
13



Cubic Evolution
T2/T3 | Table
14



Liquid Line TY | System
40mm Table Symmetric
14



Liquid Line TX | System
40mm Table Asymmetric
15

Tisch | Table | Table

Lucille T1 | Table

catalogue page 54



Microprismatic | Direct

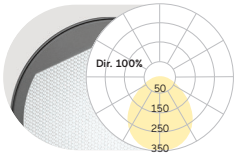

Control Gear	Colour Temperature	Power	Lumen/Watt	Weight kg	Code Ivory White	Code Jet Black	CHF
Switch & Dim	4000K	Medium	1000lm/13W	3,9	UT1AVS-840M-D150-T	UT1ABS-840M-D150-T	524,00

D mm
150

Lumen/Watt
Medium Power
1000lm/13W

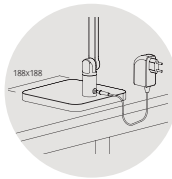

Table Base

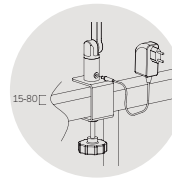

Table Clamp

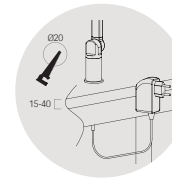
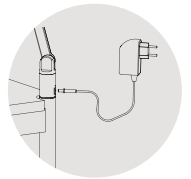

Table Grommet



USM Haller Adaptor

Surcharges

Surface Finish	CHF	Colour Rendering	CHF	Colour Temperature	CHF	Base Type	CHF
V: Ivory White	✓	8: CRI>80	✓	27: 2700K	+5%	G: Table Base	+51,00
A: Satin Silver	+15%	9: CRI>90	+5%	30: 3000K	✓	T: Table Clamp	✓
B: Jet Black	✓	F: Full Spectrum	+15%	35: 3500K	+5%	G: Table Grommet	✓
H: Anodic Champagne	+10%			40: 4000K	✓	A: USM Haller Adaptor	+51,00
R: Special RAL/NCS Colours	🔴			65: 6500K	+5%		

🟢 standard / no extra charge 🔴 on request 🚫 not available

Beam Me Up T1 | Mini Table Office

catalogue page 56

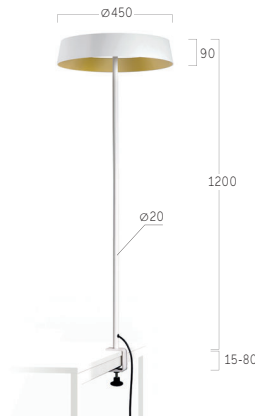

Microprismatic | Direct-Indirect

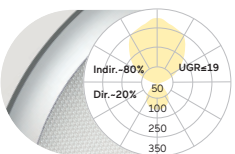

D	Control Gear	Colour Temperature	Power	Lumen/Watt	Weight kg	Code Snow White	Code Satin Silver	CHF
450	Separately Dimmable	4000K	Medium	9050lm/74W	7,4	MT1AWX-840M-D450-TW-A	MT1AAX-840M-D450-TA-A	1451,00

Opal Diffuser | Direct-Indirect

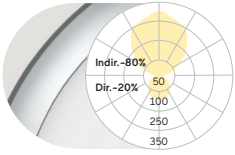

D	Control Gear	Colour Temperature	Power	Lumen/Watt	Weight kg	Code Snow White	Code Satin Silver	CHF
450	Separately Dimmable	4000K	Medium	9050lm/74W	7,4	MT10WX-840M-D450-TW-A	MT10AX-840M-D450-TA-A	1399,00

Surcharges

Surface / Reflector Finish	CHF	Surface / Reflector Finish	CHF	Colour Rendering	CHF	Colour Temperature	CHF	Plug	CHF
Uni-Colours		Dual Colours		8: CRI>80	✓	22: 2200K	+5%	A: Schuko CEE 7/7 (Type E+F)	✓
W...W: Snow White / Snow White	✓	W...G: Snow White / Satin Gold	+15%	9: CRI>90	+5%	27: 2700K	+5%	B: CH T12 (Type J)	✓
A...A: Satin Silver / Satin Silver	✓	W...K: Snow White / Satin Copper	+15%	F: Full Spectrum	+15%	30: 3000K	✓	C: UK BS 1363 (Type G)	✓
U...U: Urban Graphite / Urban Graphite	✓	W...B: Snow White / Jet Black	+15%			35: 3500K	+5%	D: Wieland	⚠
B...B: Jet Black / Jet Black	✓	H...B: Anodic Champagne / Jet Black	+15%			40: 4000K	✓	E: WAGO	⚠
H...H: Anodic Champ./ Anodic Champ.	✓	B...G: Jet Black / Satin Gold	+15%			65: 6500K	+5%		
K...K: Satin Copper / Satin Copper	✓	B...W: Jet Black / Snow White	+15%						

✓ standard / no extra charge ⚠ on request ✗ not available

Beam Me Up T2 | Mini Table Home

catalogue page 58



Microprismatic | Direct-Indirect

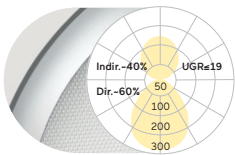

D	Control Gear	Colour Temperature	Power	Lumen/Watt	Weight kg	Code Snow White	Code Satin Silver	CHF
350	Separately Dimmable	4000K	Medium	2760lm/27W	7,0	MT2AWX-840M-D350-GW-A	MT2AAX-840M-D350-GA-A	1031,00
450	Separately Dimmable	4000K	Medium	3540lm/33W	9,7	MT2AWX-840M-D450-GW-A	MT2AAX-840M-D450-GA-A	1206,00

Opal Diffuser | Direct-Indirect

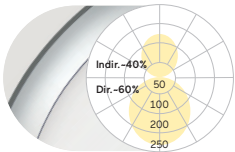

D	Control Gear	Colour Temperature	Power	Lumen/Watt	Weight kg	Code Snow White	Code Satin Silver	CHF
350	Separately Dimmable	4000K	Medium	2760lm/27W	7,0	MT2OWX-840M-D350-GW-A	MT2OAX-840M-D350-GA-A	979,00
450	Separately Dimmable	4000K	Medium	3540lm/33W	9,7	MT2OWX-840M-D450-GW-A	MT2OAX-840M-D450-GA-A	1154,00

Surcharges

Surface / Reflector Finish	CHF	Surface / Reflector Finish	CHF	Colour Rendering	CHF	Colour Temperature	CHF	Plug	CHF
Uni-Colours		Dual Colours		8: CRI>80	✓	22: 2200K	+5%	A: Schuko CEE 7/7 (Type E+F)	✓
W...W: Snow White / Snow White	✓	W...G: Snow White / Satin Gold	+15%	9: CRI>90	+5%	27: 2700K	+5%	B: CH T12 (Type J)	✓
A...A: Satin Silver / Satin Silver	✓	W...K: Snow White / Satin Copper	+15%	F: Full Spectrum	+15%	30: 3000K	✓	C: UK BS 1363 (Type G)	✓
U...U: Urban Graphite / Urban Graphite	✓	W...B: Snow White / Jet Black	+15%					D: Wieland	⚠
B...B: Jet Black / Jet Black	✓	H...B: Anodic Champagne / Jet Black	+15%					E: WAGO	⚠
H...H: Anodic Champ./ Anodic Champ.	✓	B...G: Jet Black / Satin Gold	+15%						
K...K: Satin Copper / Satin Copper	✓	B...W: Jet Black / Snow White	+15%						

✓ standard / no extra charge ⚠ on request ✗ not available

Cubic Evolution T2/T3 | Table

catalogue page 60



CT2: Microprismatic | Direct-Indirect

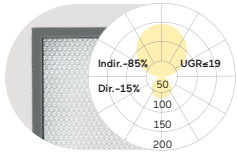

Control Gear	Colour Temperature	Power	Lumen/Watt	Weight kg	Code		CHF
					Snow White	Silver Anodised	
Separately Dimmable	4000K	Medium	11100lm/68W	8,1	CT2AWX-840M-L600-T-A	CT2AEX-840M-L600-T-A	1364,00
Multisensor	4000K	Medium	11100lm/68W	8,1	CT2AWM-840M-L600-T-A	CT2AEM-840M-L600-T-A	1661,00
Swarm Control	4000K	Medium	11100lm/68W	8,1	CT2AWR-840M-L600-T-A	CT2AER-840M-L600-T-A	1801,00
Separately Dimmable	4000K	High	15300lm/92W	8,1	CT2AWX-840H-L600-T-A	CT2AEX-840H-L600-T-A	1539,00
Multisensor	4000K	High	15300lm/92W	8,1	CT2AWM-840H-L600-T-A	CT2AEM-840H-L600-T-A	1836,00
Swarm Control	4000K	High	15300lm/92W	8,1	CT2AWR-840H-L600-T-A	CT2AER-840H-L600-T-A	1976,00

CT3: Microprismatic | Direct-Indirect

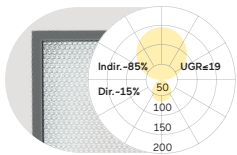

Control Gear	Colour Temperature	Power	Lumen/Watt	Weight kg	Code		CHF
					Snow White	Silver Anodised	
Separately Dimmable	4000K	Medium	11100lm/75W	8,1	CT3AWX-840M-L600-T-A	CT3AEX-840M-L600-T-A	1364,00
Multisensor	4000K	Medium	11100lm/75W	8,1	CT3AWM-840M-L600-T-A	CT3AEM-840M-L600-T-A	1661,00
Swarm Control	4000K	Medium	11100lm/75W	8,1	CT3AWR-840M-L600-T-A	CT3AER-840M-L600-T-A	1801,00
Separately Dimmable	4000K	High	15300lm/104W	8,1	CT3AWX-840H-L600-T-A	CT3AEX-840H-L600-T-A	1539,00
Multisensor	4000K	High	15300lm/104W	8,1	CT3AWM-840H-L600-T-A	CT3AEM-840H-L600-T-A	1836,00
Swarm Control	4000K	High	15300lm/104W	8,1	CT3AWR-840H-L600-T-A	CT3AER-840H-L600-T-A	1976,00

Surcharges

Surface Finish	CHF
W: Snow White	✓
E: Silver Anodised	✓
U: Urban Graphite	✓
B: Jet Black	✓
H: Anodic Champagne	+10%
R: Special RAL/NCS Colours	ⓘ

Colour Rendering	CHF
8: CRI>80	✓
9: CRI>90	+5%
F: Full Spectrum	+15%

Colour Temperature	CHF
27: 2700K	+5%
30: 3000K	✓
35: 3500K	+5%
40: 4000K	✓
65: 6500K	+5%

Plug	CHF
A: Schuko CEE 7/7 (Type E+F)	✓
B: CH T12 (Type J)	✓
C: UK BS 1363 (Type G)	✓
D: Wieland	ⓘ
E: WAGO	ⓘ

✓ standard / no extra charge ⓘ on request ✗ not available

Liquid Line TY | System 40mm Table Symmetric

catalogue page 62

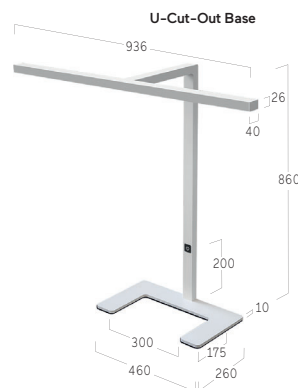

Lens Louvre | Direct

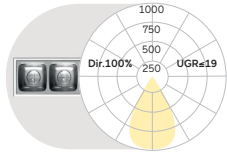

Control Gear

Switch & Dimm

Colour Temperature

4000K

Power

Medium

Lumen/Watt

1910lm/16W

Weight kg

8,4

Code Snow White/Jet Black

QTYLWS-840M-L936-TB

Code Jet Black/Jet Black

QTYLBS-840M-L936-TB

CHF

1014,00



Rectangular Base



U-Cut-Out Base



Table Clamp

Surcharges

Surface Finish

CHF

W: Snow White	✓
V: Ivory White	✓
A: Satin Silver	+15%
S: Radiant Silver	✓
U: Urban Graphite	✓
B: Jet Black	✓
H: Anodic Champagne	+10%
K: Satin Copper	+15%
R: Special RAL/NCS Colours	📌

Colour Rendering

CHF

8: CRI>80	✓
9: CRI>90	+5%
F: Full Spectrum	+15%

Colour Temperature

CHF

27: 2700K	+5%
30: 3000K	✓
35: 3500K	+5%
40: 4000K	✓
65: 6500K	+5%

Base

CHF

G: Rectangular Base	+51,00
U: U-Cut-Out Base	+51,00
T: Table Clamp	✓

Lens Louvre

CHF

W: Snow White	✓
A: Satin Silver	✓
G: Satin Gold	✓
B: Jet Black	✓
H: Anodic Champagne	✓
K: Satin Copper	✓

✓ standard / no extra charge 📌 on request ✗ not available

Liquid Line TX | System 40mm Table Asymmetric

catalogue page 64

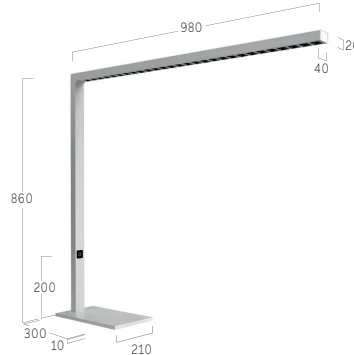

Lens Louvre | Direct

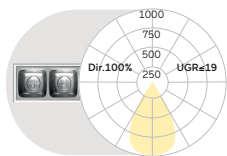

Control Gear

Switch & Dimm

Colour Temperature

4000K

Power

Medium

Lumen/Watt

1910lm/16W

Weight kg

7,4

Code Snow White/Jet Black

QTXLWS-840M-L980-TB

Code Jet Black/Jet Black

QTXLBS-840M-L980-TB

CHF

926,00



Rectangular Base



Table Clamp

Surcharges

Surface Finish

CHF

W: Snow White	✓
V: Ivory White	✓
A: Satin Silver	+15%
S: Radiant Silver	✓
U: Urban Graphite	✓
B: Jet Black	✓
H: Anodic Champagne	+10%
K: Satin Copper	+15%
R: Special RAL/NCS Colours	📌

Colour Rendering

CHF

8: CRI>80	✓
9: CRI>90	+5%
F: Full Spectrum	+15%

Colour Temperature

CHF

27: 2700K	+5%
30: 3000K	✓
35: 3500K	+5%
40: 4000K	✓
65: 6500K	+5%

Base

CHF

G: Rectangular Base	+51,00
T: Table Clamp	✓

Lens Louvre

CHF

W: Snow White	✓
A: Satin Silver	✓
B: Jet Black	✓
H: Anodic Champagne	✓
K: Satin Copper	✓
G: Satin Gold	✓

✓ standard / no extra charge 📌 on request ✗ not available



Grand Lucille S9 |
Floor
18



Lucille S1 |
Floor
18



Basic Neo S2 |
Floor
19



Basic Neo S4 |
Floor
19



Basic Déco S3 |
Floor
20



Basic Déco S5 |
Floor
20



Beam Me Up S1 |
Mini Floor
21



Beam Me Up S4 |
Floor
21



Beam Me Up S6 |
Floor
22



Liquid Line SX | System
40mm Floor One Head
23



Liquid Line SY | System
40mm Floor Two Heads
23



Caleo Neo S2 |
Floor
24



Caleo Neo S4 |
Floor
24



Cubic Evolution F1 |
Floor
25



Cubic Evolution F2 |
Floor
26



Cubic Evolution F3 |
Floor
26



Cubic Evolution F5/F6 |
Floor
27



Cubic Evolution F7 |
Floor
28



Cubic Evolution F8 |
Floor
28



Matric SX | System 40mm
Floor One Head
29



Matric SY | System 40 mm
Floor Two Heads
29

Steh | Floor | Lampadaire

Grand Lucille S9 | Floor

catalogue page 70

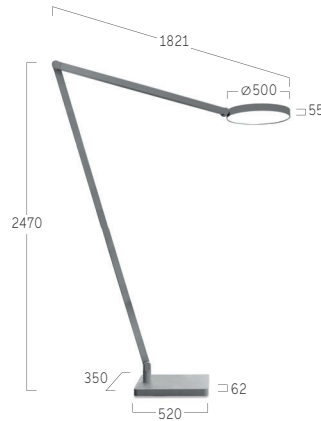

Microprismatic | Direct-Indirect

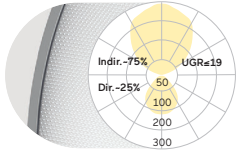

Control Gear	Colour Temperature	Power	Lumen/Watt	Weight kg	Code	Code	CHF
Separately Dimmable	4000K	High	10700lm/80W	78,6	US9AWX-840H-D500-P-A	US9ABX-840H-D500-P-A	6895,00

Surcharges

Surface	CHF	Colour Rendering	CHF	Colour Temperature	CHF	Plug	CHF
W: Snow White	✓	8: CRI>80	✓	27: 2700K	+5%	A: Schuko CEE 7/7 (Type E+F)	✓
A: Satin Silver	+15%	9: CRI>90	+5%	30: 3000K	✓	B: CH T12 (Type J)	✓
U: Urban Graphite	✓	F: Full Spectrum	+15%	35: 3500K	+5%	C: UK BS 1363 (Type G)	✓
B: Jet Black	✓			40: 4000K	✓	D: Wieland	⚠
H: Anodic Champagne	+10%			65: 6500K	+5%	E: WAGO	⚠
K: Satin Copper	+15%			TW: Tunable White 2700-6500K	+30%		
R: Special RAL/NCS Colours	⚠						

✓ standard / no extra charge ⚠ on request ✗ not available

Lucille S1 | Floor

catalogue page 74

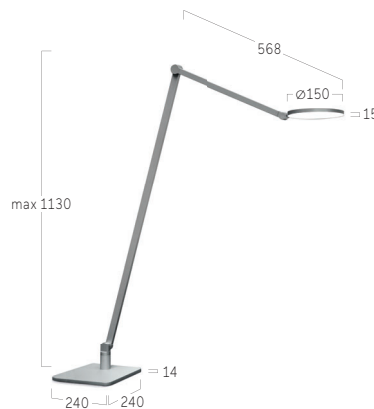

Microprismatic | Direct

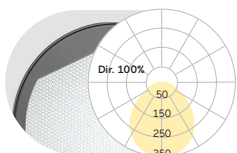

Control Gear	Colour Temperature	Power	Lumen/Watt	Weight kg	Code	Code	CHF
Switch & Dimm	4000K	Medium	1000lm/13W	12,5	US1AVS-840M-D150-P	US1ABX-840M-D150-P	926,00

Surcharges

Surface	CHF	Colour Rendering	CHF	Colour Temperature	CHF
V: Ivory White	✓	8: CRI>80	✓	27: 2700K	+5%
A: Satin Silver	+15%	9: CRI>90	+5%	30: 3000K	✓
B: Jet Black	✓	F: Full Spectrum	+15%	35: 3500K	+5%
H: Anodic Champagne	+10%			40: 4000K	✓
K: Satin Copper	+15%			65: 6500K	+5%
R: Special RAL/NCS Colours	⚠				

✓ standard / no extra charge ⚠ on request ✗ not available

Basic Neo S2 | Floor

catalogue page 78

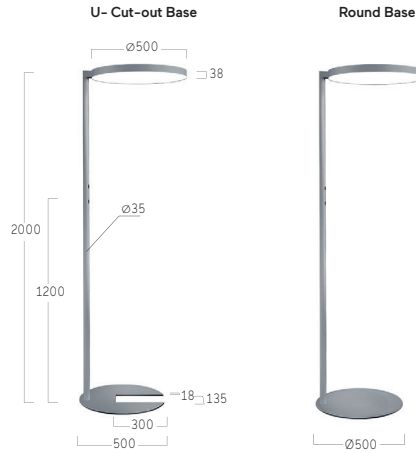

Microprismatic | Direct-Indirect

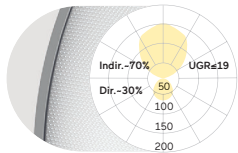

Control Gear	Colour Temperature	Power	Lumen/Watt	Weight kg	Code Snow White	Code Radiant Silver	CHF
Separately Dimmable	4000K	Medium	11700lm/81W	21,0	BS2AWX-840M-D500-U-A	BS2ASX-840M-D500-U-A	1836,00
Multisensor	4000K	Medium	11700lm/81W	21,0	BS2AWM-840M-D500-U-A	BS2ASM-840M-D500-U-A	2134,00
Swarm Control	4000K	Medium	11700lm/81W	21,0	BS2AWR-840M-D500-U-A	BS2ASR-840M-D500-U-A	2274,00
HCL	Tunable White	Medium	9700lm/77W	21,0	BS2AWB-8TWM-D500-U-A	BS2ASB-8TWM-D500-U-A	2484,00

Surcharges

Surface	CHF	Colour Rendering	CHF	Colour Temperature	CHF	Base	CHF
W: Snow White	✓	8: CRI>80	✓	27: 2700K	+5%	U: U-Cut-Out Base	✓
V: Ivory White	✓	9: CRI>90	+5%	30: 3000K	✓	O: Round Base	✓
S: Radiant Silver	✓	F: Full Spectrum	+15%	35: 3500K	+5%	Plug	CHF
U: Urban Graphite	✓			40: 4000K	✓	A: Schuko CEE 7/7 (Type E+F)	✓
B: Jet Black	✓			65: 6500K	+5%	B: CH T12 (Type J)	✓
H: Anodic Champagne	+10%					C: UK BS 1363 (Type G)	✓
K: Satin Copper	+15%					D: Wieland	⚠
R: Special RAL/NCS Colours	⚠					E: WAGO	⚠

✓ standard / no extra charge ⚠ on request ✗ not available

Basic Neo Floor | S4

catalogue page 80

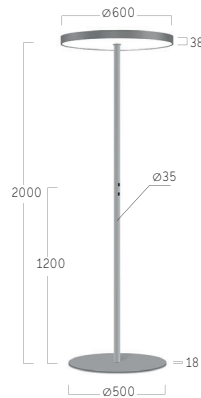

Microprismatic | Direct-Indirect

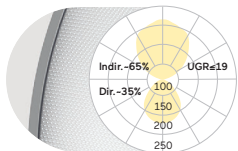

Control Gear	Colour Temperature	Power	Lumen/Watt	Weight kg	Code Snow White	Code Radiant Silver	CHF
Separately Dimmable	4000K	Medium	12700lm/88W	24,0	BS4AWX-840M-D600-O-A	BS4ASX-840M-D600-O-A	1836,00
Multisensor	4000K	Medium	12700lm/88W	24,0	BS4AWM-840M-D600-O-A	BS4ASM-840M-D600-O-A	2134,00
Swarm Control	4000K	Medium	12700lm/88W	24,0	BS4AWR-840M-D600-O-A	BS4ASR-840M-D600-O-A	2274,00
HCL	Tunable White	Medium	10600lm/84W	24,0	BS4AWB-8TWM-D600-O-A	BS4ASB-8TWM-D600-O-A	2484,00

Surcharges

Surface	CHF	Colour Rendering	CHF	Colour Temperature	CHF	Plug	CHF
W: Snow White	✓	8: CRI>80	✓	27: 2700K	+5%	A: Schuko CEE 7/7 (Type E+F)	✓
V: Ivory White	✓	9: CRI>90	+5%	30: 3000K	✓	B: CH T12 (Type J)	✓
S: Radiant Silver	✓	F: Full Spectrum	+15%	35: 3500K	+5%	C: UK BS 1363 (Type G)	✓
U: Urban Graphite	✓			40: 4000K	✓	D: Wieland	⚠
B: Jet Black	✓			65: 6500K	+5%	E: WAGO	⚠
H: Anodic Champagne	+10%						
K: Satin Copper	+15%						
R: Special RAL/NCS Colours	⚠						

✓ standard / no extra charge ⚠ on request ✗ not available

Basic Déco S3 | Floor

catalogue page 82

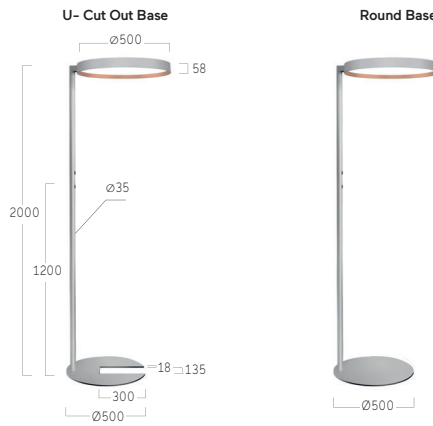

Microprismatic | Direct-Indirect

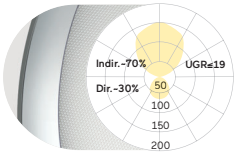

Control Gear	Colour Temperature	Power	Lumen/Watt	Weight kg	Code Snow White	Code Radiant Silver	CHF
Separately Dimmable	4000K	Medium	11700lm/81W	22,0	BS3AWX-840M-D500-UW-A	BS3ASX-840M-D500-US-A	1941,00
Multisensor	4000K	Medium	11700lm/81W	22,0	BS3AWM-840M-D500-UW-A	BS3ASM-840M-D500-US-A	2183,00
Swarm Control	4000K	Medium	11700lm/81W	22,0	BS3AWR-840M-D500-UW-A	BS3ASR-840M-D500-US-A	2379,00
HCL	Tunable White	Medium	9700lm/77W	22,0	BS3AWB-8TWM-D500-UW-A	BS3ASB-8TWM-D500-US-A	2589,00

Surcharges

Surface / Reflector Finish	CHF	Surface / Reflector Finish	CHF	Colour Rendering	CHF	Colour Temperature	CHF	Base	CHF
Uni-Colours		Dual Colours		8: CRI>80	✓	27: 2700K	+5%	U: U-Cut-Out Base	✓
W...W: Snow White / Snow White	✓	W...G: Snow White / Satin Gold	+15%	9: CRI>90	+5%	30: 3000K	✓	O: Round Base	✓
S...S: Radiant Silver / Radiant Silver	✓	W...K: Snow White / Satin Copper	+15%	F: Full Spectrum	+15%	35: 3500K	+5%	Plug	CHF
U...U: Urban Graphite / Urban Graphite	✓	W...B: Snow White / Jet Black	+15%			40: 4000K	✓	A: Schuko CEE 7/7 (Type E+F)	✓
B...B: Jet Black / Jet Black	✓	H...B: Anodic Champagne / Jet Black	+15%			65: 6500K	+5%	B: CH T12 (Type J)	✓
H...H: Anodic Champ./ Anodic Champ.	✓	B...G: Jet Black / Satin Gold	+15%					C: UK BS 1363 (Type G)	✓
K...K: Satin Copper / Satin Copper	✓	B...W: Jet Black / Snow White	+15%					D: Wieland	⚠
								E: WAGO	⚠

✓ standard / no extra charge ⚠ on request ✗ not available

Basic Déco S5 | Floor

catalogue page 84

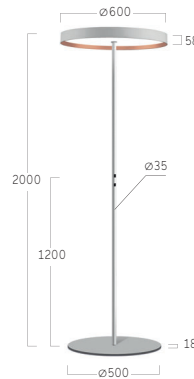

Microprismatic | Direct-Indirect

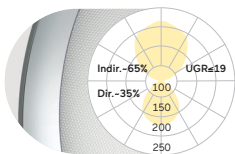

Control Gear	Colour Temperature	Power	Lumen/Watt	Weight kg	Code Snow White	Code Radiant Silver	CHF
Separately Dimmable	4000K	Medium	12700lm/88W	24,0	BS5AWX-840M-D600-OW-A	BS5ASX-840M-D600-OS-A	2029,00
Multisensor	4000K	Medium	12700lm/88W	24,0	BS5AWM-840M-D600-OW-A	BS5ASM-840M-D600-OS-A	2326,00
Swarm Control	4000K	Medium	12700lm/88W	24,0	BS5AWR-840M-D600-OW-A	BS5ASR-840M-D600-OS-A	2466,00
HCL	Tunable White	Medium	10600lm/84W	24,0	BS5AWB-8TWM-D600-OW-A	BS5ASB-8TWM-D600-OS-A	2676,00

Surcharges

Surface / Reflector Finish	CHF	Surface / Reflector Finish	CHF	Colour Rendering	CHF	Colour Temperature	CHF	Plug	CHF
Uni-Colours		Dual Colours		8: CRI>80	✓	27: 2700K	+5%	A: Schuko CEE 7/7 (Type E+F)	✓
W...W: Snow White / Snow White	✓	W...G: Snow White / Satin Gold	+15%	9: CRI>90	+5%	30: 3000K	✓	B: CH T12 (Type J)	✓
S...S: Radiant Silver / Radiant Silver	✓	W...K: Snow White / Satin Copper	+15%	F: Full Spectrum	+15%	35: 3500K	+5%	C: UK BS 1363 (Type G)	✓
U...U: Urban Graphite / Urban Graphite	✓	W...B: Snow White / Jet Black	+15%			40: 4000K	✓	D: Wieland	⚠
B...B: Jet Black / Jet Black	✓	H...B: Anodic Champagne / Jet Black	+15%			65: 6500K	+5%	E: WAGO	⚠
H...H: Anodic Champ./ Anodic Champ.	✓	B...G: Jet Black / Satin Gold	+15%						
K...K: Satin Copper / Satin Copper	✓	B...W: Jet Black / Snow White	+15%						

✓ standard / no extra charge ⚠ on request ✗ not available

Beam Me Up S1 | Mini Floor

catalogue page 86

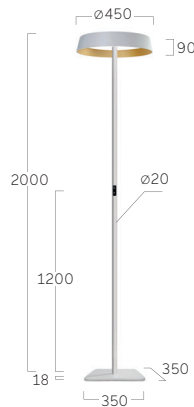

Microprismatic | Direct-Indirect

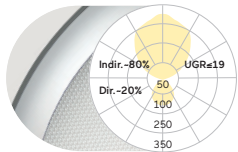

Control Gear	Colour Temperature	Power	Lumen/Watt	Weight kg	Code Snow White	Code Satin Silver	CHF
Separately Dimmable	4000K	Medium	9050lm/74W	17,1	MS1AWX-840M-D450-CW-A	MS1AAX-840M-D450-CA-A	1714,00

Opal Diffuser | Direct-Indirect

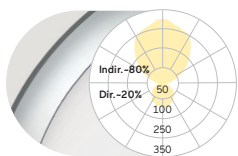

Control Gear	Colour Temperature	Power	Lumen/Watt	Weight kg	Code Snow White	Code Satin Silver	CHF
Separately Dimmable	4000K	Medium	9050lm/74W	17,1	MS1OWX-840M-D450-CW-A	MS1OAX-840M-D450-CA-A	1661,00

Surcharges

Surface / Reflector Finish

Uni-Colours

Code	Finish	Surcharge
W...W:	Snow White / Snow White	✓
A...A:	Satin Silver / Satin Silver	✓
U...U:	Urban Graphite / Urban Graphite	✓
B...B:	Jet Black / Jet Black	✓
H...H:	Anodic Champ./ Anodic Champ.	✓
K...K:	Satin Copper / Satin Copper	✓

Surface / Reflector Finish

Dual Colours

Code	Finish	Surcharge
W...G:	Snow White / Satin Gold	+15%
W...K:	Snow White / Satin Copper	+15%
W...B:	Snow White / Jet Black	+15%
H...B:	Anodic Champagne / Jet Black	+15%
B...G:	Jet Black / Satin Gold	+15%
B...W:	Jet Black / Snow White	+15%

Colour Rendering

Code	Value	Surcharge
8:	CRI>80	✓
9:	CRI>90	+5%
F:	Full Spectrum	+15%

Colour Temperature

Code	Temperature	Surcharge
22:	2200K	+5%
27:	2700K	+5%
30:	3000K	✓
35:	3500K	+5%
40:	4000K	✓
65:	6500K	+5%

Plug

Code	Plug Type	Surcharge
A:	Schuko CEE 7/7 (Type E+F)	✓
B:	CH T12 (Type J)	✓
C:	UK BS 1363 (Type G)	✓
D:	Wieland	⚠
E:	WAGO	⚠

✓ standard / no extra charge ⚠ on request ✗ not available

Beam Me Up S4 | Floor

catalogue page 88

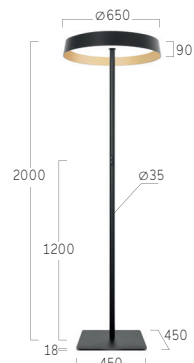

Microprismatic | Direct-Indirect

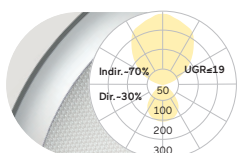

Control Gear	Colour Temperature	Power	Lumen/Watt	Weight kg	Code Snow White	Code Satin Silver	CHF
Separately Dimmable	4000K	Medium	11900lm/93W	27,5	MS4AWX-840M-D650-CW-A	MS4AAX-840M-D650-CA-A	2170,00
Multisensor	4000K	Medium	11900lm/93W	27,5	MS4AWM-840M-D650-CW-A	MS4AAM-840M-D650-CA-A	2468,00
Swarm Control	4000K	Medium	11900lm/93W	27,5	MS4AWR-840M-D650-CW-A	MS4AAR-840M-D650-CA-A	2608,00
HCL	Tunable White	Medium	9800lm/75W	27,5	MS4AWB-8TWM-D650-CW-A	MS4AAB-8TWM-D650-CA-A	2818,00

... Beam Me Up S4 | Floor

Opal Diffuser | Direct-Indirect

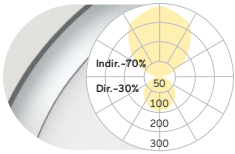

Control Gear	Colour Temperature	Power	Lumen/Watt	Weight kg	Code Snow White	Code Satin Silver	CHF
Separately Dimmable	4000K	Medium	12000lm/93W	27,5	MS4OWX-840M-D650-CW-A	MA4OAX-840M-D650-CA-A	2083,00
Multisensor	4000K	Medium	12000lm/93W	27,5	MS4OWM-840M-D650-CW-A	MA4OAM-840M-D650-CA-A	2380,00
Swarm Control	4000K	Medium	12000lm/93W	27,5	MS4OWR-840M-D650-CW-A	MA4OAR-840M-D650-CA-A	2520,00
HCL	Tunable White	Medium	9900lm/75W	27,5	MS4OWB-8TWM-D650-CW-A	MA4OAB-8TWM-D650-CA-A	2730,00

Surcharges

Surface / Reflector Finish	CHF	Surface / Reflector Finish	CHF	Colour Rendering	CHF	Colour Temperature	CHF	Plug	CHF
Uni-Colours		Dual Colours		8: CRI>80		22: 2200K	+5%	A: Schuko CEE 7/7 (Type E+F)	✓
W...W: Snow White / Snow White	✓	W...G: Snow White / Satin Gold	+15%	9: CRI>90	+5%	27: 2700K	+5%	B: CH T12 (Type J)	✓
A...A: Satin Silver / Satin Silver	✓	W...K: Snow White / Satin Copper	+15%	F: Full Spectrum	+15%	30: 3000K	✓	C: UK BS 1363 (Type G)	✓
U...U: Urban Graphite / Urban Graphite	✓	W...B: Snow White / Jet Black	+15%			35: 3500K	+5%	D: Wieland	⚠
B...B: Jet Black / Jet Black	✓	H...B: Anodic Champagne / Jet Black	+15%			40: 4000K	✓	E: WAGO	⚠
H...H: Anodic Champ./ Anodic Champ.	✓	B...G: Jet Black / Satin Gold	+15%			65: 6500K	+5%		
K...K: Satin Copper / Satin Copper	✓	B...W: Jet Black / Snow White	+15%						

✓ standard / no extra charge ⚠ on request ✗ not available

Beam Me Up S6 | Floor

catalogue page 90



Square with Soft Corners

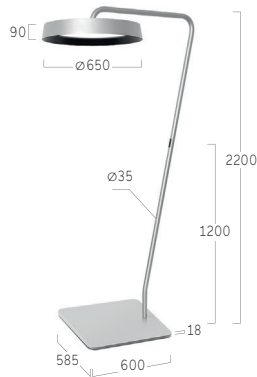

U- Cut Out Base



Microprismatic | Direct-Indirect

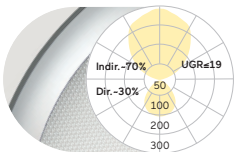

Control Gear	Colour Temperature	Power	Lumen/Watt	Weight kg	Code Snow White	Code Satin Silver	CHF
Separately Dimmable	4000K	Medium	11900lm/93W	33,6	MS6AWX-840M-D650-UW-A	MS6AAX-840M-D650-UA-A	3745,00

Opal Diffuser | Direct-Indirect

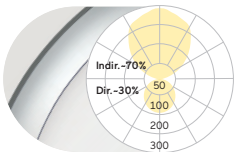

Control Gear	Colour Temperature	Power	Lumen/Watt	Weight kg	Code Snow White	Code Satin Silver	CHF
Separately Dimmable	4000K	Medium	12000lm/93W	33,6	MS6OWX-840M-D650-UW-A	MS6OAX-840M-D650-UA-A	3570,00

Surcharges

Surface / Reflector Finish	CHF	Surface / Reflector Finish	CHF	Colour Rendering	CHF	Colour Temperature	CHF	Base	CHF
Uni-Colours		Dual Colours		8: CRI>80		22: 2200K	+5%	U: U-Cut-Out Base	✓
W...W: Snow White / Snow White	✓	W...G: Snow White / Satin Gold	+15%	9: CRI>90	+5%	27: 2700K	+5%	P: Rectangular Base	✓
A...A: Satin Silver / Satin Silver	✓	W...K: Snow White / Satin Copper	+15%	F: Full Spectrum	+15%	30: 3000K	✓	Plug CHF	
U...U: Urban Graphite / Urban Graphite	✓	W...B: Snow White / Jet Black	+15%			35: 3500K	+5%	A: Schuko CEE 7/7 (Type E+F)	✓
B...B: Jet Black / Jet Black	✓	H...B: Anodic Champagne / Jet Black	+15%			40: 4000K	✓	B: CH T12 (Type J)	✓
H...H: Anodic Champ./ Anodic Champ.	✓	B...G: Jet Black / Satin Gold	+15%			65: 6500K	+5%	C: UK BS 1363 (Type G)	✓
K...K: Satin Copper / Satin Copper	✓	B...W: Jet Black / Snow White	+15%			TW: Tunable White 2700-6500K	+30%	D: Wieland	⚠
								E: WAGO	⚠

✓ standard / no extra charge ⚠ on request ✗ not available

Liquid Line SX | System 40 mm Floor One Head

catalogue page 92

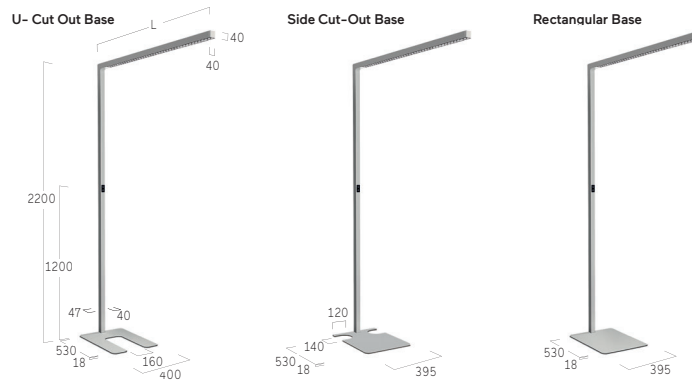

Lens Louvre | Direct-Indirect

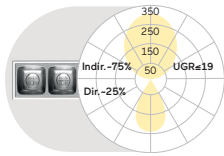

Control Gear	Colour Temperature	Power	Lumen/Watt	Weight kg	Code Snow White/Jet Black	Code Jet Black/Jet Black	CHF
Separately Dimmable	4000K	Medium	10300lm/85W	19,8	QSXLWX-840M-L1490-UB-A	QSXLBX-840M-L1490-UB-A	2326,00
Multisensor	4000K	Medium	10300lm/85W	20,3	QSXLWM-840M-L1590-UB-A	QSXLBM-840M-L1590-UB-A	2624,00
Swarm Control	4000K	Medium	10300lm/85W	20,3	QSXLWR-840M-L1590-UB-A	QSXLBR-840M-L1590-UB-A	2764,00
HCL	Tunable White	Medium	4900lm/43W	20,3	QSXLWB-8TWM-L1590-UB-A	QSXLBB-8TWM-L1590-UB-A	2974,00

Surcharges

Surface Finish	CHF	Colour Rendering	CHF	Colour Temperature	CHF	Lens Louvre	CHF	Base	CHF
W: Snow White	✓	8: CRI>80	✓	27: 2700K	+5%	W: Snow White	✓	S: Side Cut-Out	✓
V: Ivory White	✓	9: CRI>90	+5%	30: 3000K	✓	A: Satin Silver	✓	U: U-Cut-Out	✓
A: Satin Silver	+15%	F: Full Spectrum	+15%	35: 3500K	+5%	B: Jet Black	✓	P: Rectangular	✓
S: Radiant Silver	✓			40: 4000K	✓	H: Anodic Champagne	✓	Plug	CHF
U: Urban Graphite	✓			65: 6500K	+5%	K: Satin Copper	✓	A: Schuko CEE 7/7 (Type E+F)	✓
B: Jet Black	✓					G: Satin Gold	✓	B: CH T12 (Type J)	✓
H: Anodic Champagne	+10%							C: UK BS 1363 (Type G)	✓
K: Satin Copper	+15%							D: Wieland	ⓘ
R: Special RAL/NCS Colours	ⓘ							E: WAGO	ⓘ

✓ standard / no extra charge ⓘ on request ✗ not available

Liquid Line SY | System 40 mm Floor Two Heads

catalogue page 94

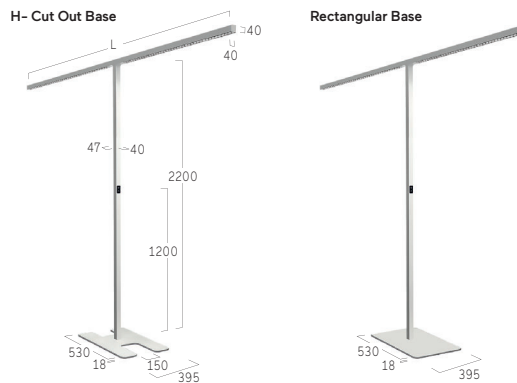

Lens Louvre | Direct-Indirect

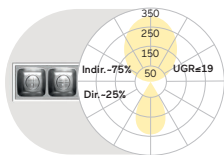

Control Gear	Colour Temperature	Power	Lumen/Watt	Weight kg	Code Snow White/Jet Black	Code Jet Black/Jet Black	CHF
Separately Dimmable	4000K	Medium	20600lm/170W	23,1	QSYLWX-840M-L2940-HB-A	QSYLXB-840M-L2940-HB-A	4547,00
Multisensor	4000K	Medium	20600lm/170W	23,6	QSYLWM-840M-L3140-HB-A	QSYLBM-840M-L3140-HB-A	5142,00
Swarm Control	4000K	Medium	20600lm/170W	23,6	QSYLWR-840M-L3140-HB-A	QSYLBR-840M-L3140-HB-A	5282,00

Surcharges

Surface Finish	CHF	Colour Rendering	CHF	Colour Temperature	CHF	Lens Louvre	CHF	Base	CHF
W: Snow White	✓	8: CRI>80	✓	27: 2700K	+5%	W: Snow White	✓	H: H-Cut-Out Base	✓
V: Ivory White	✓	9: CRI>90	+5%	30: 3000K	✓	A: Satin Silver	✓	P: Rectangular Base	✓
A: Satin Silver	+15%	F: Full Spectrum	+15%	35: 3500K	+5%	B: Jet Black	✓	Plug	CHF
S: Radiant Silver	✓			40: 4000K	✓	H: Anodic Champagne	✓	A: Schuko CEE 7/7 (Type E+F)	✓
U: Urban Graphite	✓			65: 6500K	+5%	K: Satin Copper	✓	B: CH T12 (Type J)	✓
B: Jet Black	✓					G: Satin Gold	✓	C: UK BS 1363 (Type G)	✓
H: Anodic Champagne	+10%							D: Wieland	ⓘ
K: Satin Copper	+15%							E: WAGO	ⓘ
R: Special RAL/NCS Colours	ⓘ								

✓ standard / no extra charge ⓘ on request ✗ not available

Caleo Neo S2 | Floor

catalogue page 96

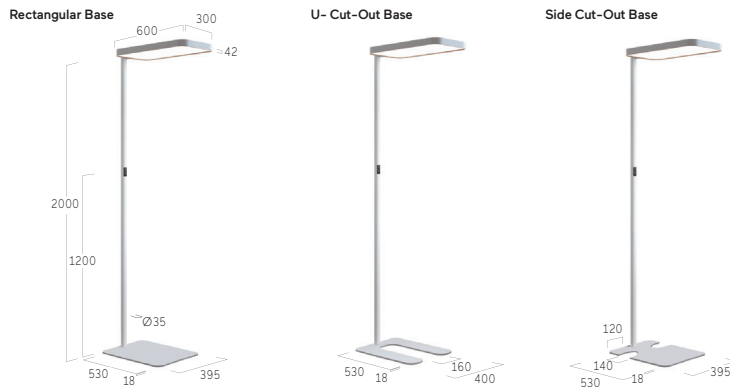

IP20, ~220-240V, 50-60 Hz, IK 02, ≤3 MacAdam, MEDIUM POWER 485lm/5000h, HIGH POWER 480lm/5000h, CE, UK CA

Microprismatic| Direct-Indirect

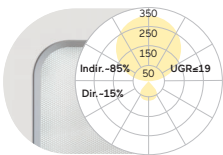

Control Gear	Colour Temperature	Power	Lumen/Watt	Weight kg	Code Snow White	Code Radiant Silver	CHF
Separately Dimmable	4000K	Medium	11000lm/73W	19,3	AS2AWX-840M-L600-UW-A	AS2ASX-840M-L600-US-A	1556,00
Separately Dimmable	4000K	High	14500lm/96W	19,3	AS2AWX-840H-L600-UW-A	AS2ASX-840H-L600-US-A	1731,00

Surcharges

Surface / Reflector Finish	CHF	Surface / Reflector Finish	CHF	Colour Rendering	CHF	Base	CHF
Uni-Colours		Dual Colours		8: CRI>80	✓	S: Side Cut-Out	✓
W...W: Snow White / Snow White	✓	W...G: Snow White / Satin Gold	+15%	9: CRI>90	+5%	U: U-Cut-Out	✓
V...V: Ivory White / Ivory White	✓	W...K: Snow White / Satin Copper	+15%	F: Full Spectrum	+15%	P: Rectangular	✓
S...S: Radiant Silver / Radiant Silver	✓	W...B: Snow White / Jet Black	+15%	Colour Temperature	CHF	Plug	CHF
U...U: Urban Graphite / Urban Graphite	✓	H...B: Anodic Champagne / Jet Black	+15%	27: 2700K	+5%	A: Schuko CEE 7/7 (Type E+F)	✓
B...B: Jet Black / Jet Black	✓	B...G: Jet Black / Satin Gold	+15%	30: 3000K	✓	B: CH T12 (Type J)	✓
H...H: Anodic Champ. / Anodic Champ.	+5%	B...W: Jet Black / Snow White	+15%	35: 3500K	+5%	C: UK BS 1363 (Type G)	✓
K...K: Satin Copper / Satin Copper	+15%			40: 4000K	✓	D: Wieland	ⓘ
				65: 6500K	+5%	E: WAGO	ⓘ

✓ standard / no extra charge ⓘ on request ✗ not available

Caleo Neo Floor | S4

catalogue page 98

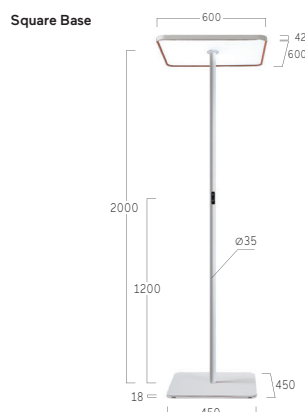

IP20, ~220-240V, 50-60 Hz, IK 02, ≤3 MacAdam, MEDIUM POWER 485lm/5000h, CE, UK CA

Microprismatic| Direct-Indirect

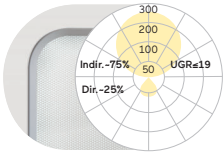

Control Gear	Colour Temperature	Power	Lumen/Watt	Weight kg	Code Snow White	Code Radiant Silver	CHF
Separately Dimmable	4000K	Medium	16800lm/115W	28,0	AS4AWX-840M-Q600-CW-A	AS4ASX-840M-Q600-CS-A	1906,00

Surcharges

Surface / Reflector Finish

Surface / Reflector Finish	CHF
Uni-Colours	
W...W: Snow White / Snow White	✓
V...V: Ivory White / Ivory White	✓
S...S: Radiant Silver / Radiant Silver	✓
U...U: Urban Graphite / Urban Graphite	✓
B...B: Jet Black / Jet Black	✓
H...H: Anodic Champ. / Anodic Champ.	+5%
K...K: Satin Copper / Satin Copper	+15%

Surface / Reflector Finish

Surface / Reflector Finish	CHF
Dual Colours	
W...G: Snow White / Satin Gold	+15%
W...K: Snow White / Satin Copper	+15%
W...B: Snow White / Jet Black	+15%
H...B: Anodic Champagne / Jet Black	+15%
B...G: Jet Black / Satin Gold	+15%
B...W: Jet Black / Snow White	+15%

Colour Rendering

Colour Rendering	CHF
8: CRI>80	✓
9: CRI>90	+5%
F: Full Spectrum	+15%
Colour Temperature	CHF
27: 2700K	+5%
30: 3000K	✓
35: 3500K	+5%
40: 4000K	✓
65: 6500K	+5%

Plug

Plug	CHF
A: Schuko CEE 7/7 (Type E+F)	✓
B: CH T12 (Type J)	✓
C: UK BS 1363 (Type G)	✓
D: Wieland	ⓘ
E: WAGO	ⓘ

✓ standard / no extra charge ⓘ on request ✗ not available

Cubic Evolution F1 | Floor

catalogue page 104

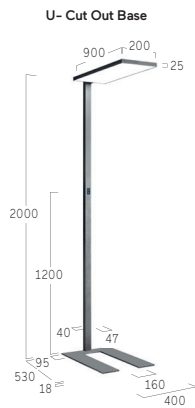

Microprismatic| Direct-Indirect

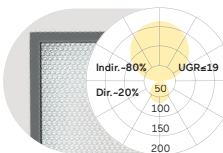

Control Gear	Colour Temperature	Power	Lumen/Watt	Weight kg	Code Snow White	Code Silver Anodised	CHF
Separately Dimmable	4000K	Medium	13900lm/95W	20,1	CF1AWX-840M-L900-U-A	CF1AEX-840M-L900-U-A	1924,00
Multisensor	4000K	Medium	13900lm/95W	20,1	CF1AWM-840M-L900-U-A	CF1AEM-840M-L900-U-A	2221,00
Swarm Control	4000K	Medium	13900lm/95W	20,1	CF1AWR-840M-L900-U-A	CF1AER-840M-L900-U-A	2361,00
HCL	Tunable White	Medium	12100lm/95W	20,1	CF1AWB-8TWM-L900-U-A	CF1AEB-8TWM-L900-U-A	2571,00
Separately Dimmable	4000K	High	16000lm/114W	20,1	CF1AWX-840H-L900-U-A	CF1AEX-840H-L900-U-A	2029,00
Multisensor	4000K	High	16000lm/114W	20,1	CF1AWM-840H-L900-U-A	CF1AEM-840H-L900-U-A	2326,00
Swarm Control	4000K	High	16000lm/114W	20,1	CF1AWR-840H-L900-U-A	CF1AER-840H-L900-U-A	2466,00
HCL	Tunable White	High	13900lm/114W	20,1	CF1AWB-8TWH-L900-U-A	CF1AEB-8TWH-L900-U-A	2676,00

Surcharges

Surface Finish	CHF
W: Snow White	✓
E: Silver Anodised	✓
U: Urban Graphite	✓
B: Jet Black	✓
H: Anodic Champagne	+10%
R: Special RAL/NCS Colours	ⓘ

Colour Rendering	CHF
8: CRI>80	✓
9: CRI>90	+5%
F: Full Spectrum	+15%

Colour Temperature	CHF
27: 2700K	+5%
30: 3000K	✓
35: 3500K	+5%
40: 4000K	✓
65: 6500K	+5%

Base	CHF
S: Side Cut-Out	✓
U: U-Cut-Out	✓
P: Rectangular	✓

Plug	CHF
A: Schuko CEE 7/7 (Type E+F)	✓
B: CH T12 (Type J)	✓
C: UK BS 1363 (Type G)	✓
D: Wieland	ⓘ
E: WAGO	ⓘ

✓ standard / no extra charge ⓘ on request ✗ not available

Cubic Evolution F2 | Floor

catalogue page 106

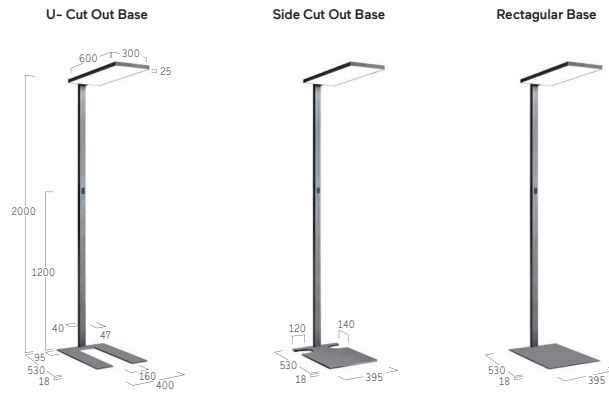

Microprismatic | Direct-Indirect

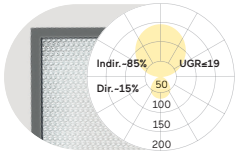

Control Gear	Colour Temperature	Power	Lumen/Watt	Weight kg	Code Snow White	Code Silver Anodised	CHF
Separately Dimmable	4000K	Medium	11100lm/68W	19,5	CF2AWX-840M-L600-U-A	CF2AEX-840M-L600-U-A	1451,00
Multisensor	4000K	Medium	11100lm/68W	19,5	CF2AWM-840M-L600-U-A	CF2AEM-840M-L600-U-A	1749,00
Swarm Control	4000K	Medium	11100lm/68W	19,5	CF2AWR-840M-L600-U-A	CF2AER-840M-L600-U-A	1889,00
HCL	Tunable White	Medium	9700lm/70W	19,5	CF2AWB-8TWM-L600-U-A	CF2AEB-8TWM-L600-U-A	2099,00
Separately Dimmable	4000K	High	15300lm/92W	19,5	CF2AWX-840H-L600-U-A	CF2AEX-840H-L600-U-A	1626,00
Multisensor	4000K	High	15300lm/92W	19,5	CF2AWM-840H-L600-U-A	CF2AEM-840H-L600-U-A	1924,00
Swarm Control	4000K	High	15300lm/92W	19,5	CF2AWR-840H-L600-U-A	CF2AER-840H-L600-U-A	2064,00
HCL	Tunable White	High	13500lm/98W	19,5	CF2AWB-8TWH-L600-U-A	CF2AEB-8TWH-L600-U-A	2274,00

Surcharges

Surface Finish	CHF	Colour Rendering	CHF	Colour Temperature	CHF	Base	CHF	Plug	CHF
W: Snow White	✓	8: CRI>80	✓	22: 2200K	+5%	S: Side Cut-Out	✓	A: Schuko CEE 7/7 (Type E+F)	✓
E: Silver Anodised	✓	9: CRI>90	+5%	27: 2700K	+5%	U: U-Cut-Out	✓	B: CH T12 (Type J)	✓
U: Urban Graphite	✓	F: Full Spectrum	+15%	30: 3000K	✓	P: Rectangular	✓	C: UK BS 1363 (Type G)	✓
B: Jet Black	✓			35: 3500K	+5%			D: Wieland	⚠
H: Anodic Champagne	+10%			40: 4000K	✓			E: WAGO	⚠
R: Special RAL/NCS Colours	⚠			65: 6500K	+5%				

✓ standard / no extra charge ⚠ on request ✗ not available

Cubic Evolution F3 | Floor

catalogue page 108

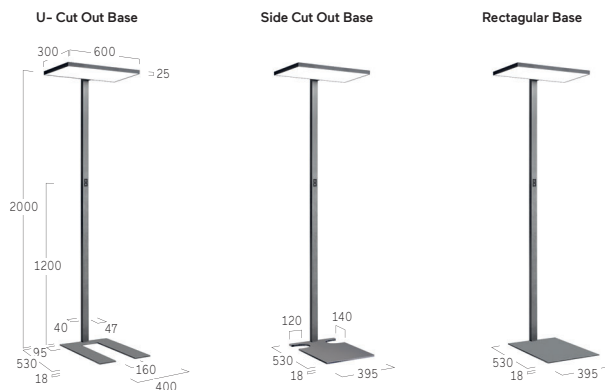

Microprismatic | Direct-Indirect

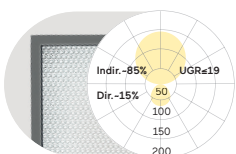

Control Gear	Colour Temperature	Power	Lumen/Watt	Weight kg	Code Snow White	Code Silver Anodised	CHF
Separately Dimmable	4000K	Medium	11100lm/75W	19,5	CF3AWX-840M-L600-U-A	CF3AEX-840M-L600-U-A	1451,00
Multisensor	4000K	Medium	11100lm/75W	19,5	CF3AWM-840M-L600-U-A	CF3AEM-840M-L600-U-A	1749,00
Swarm Control	4000K	Medium	11100lm/75W	19,5	CF3AWR-840M-L600-U-A	CF3AER-840M-L600-U-A	1889,00
HCL	Tunable White	Medium	8900lm/65W	19,5	CF3AWB-8TWM-L600-U-A	CF3AEB-8TWM-L600-U-A	2099,00
Separately Dimmable	4000K	High	15300lm/104W	19,5	CF3AWX-840H-L600-U-A	CF3AEX-840H-L600-U-A	1626,00
Multisensor	4000K	High	15300lm/104W	19,5	CF3AWM-840H-L600-U-A	CF3AEM-840H-L600-U-A	1924,00
Swarm Control	4000K	High	15300lm/104W	19,5	CF3AWR-840H-L600-U-A	CF3AER-840H-L600-U-A	2064,00
HCL	Tunable White	High	12300lm/92W	19,5	CF3AWB-8TWH-L600-U-A	CF3AEB-8TWH-L600-U-A	2274,00

Surcharges

Surface Finish	CHF	Colour Rendering	CHF	Colour Temperature	CHF	Base	CHF	Plug	CHF
W: Snow White	✓	8: CRI>80	✓	27: 2700K	+5%	S: Side Cut-Out	✓	A: Schuko CEE 7/7 (Type E+F)	✓
E: Silver Anodised	✓	9: CRI>90	+5%	30: 3000K	✓	U: U-Cut-Out	✓	B: CH T12 (Type J)	✓
U: Urban Graphite	✓	F: Full Spectrum	+15%	35: 3500K	+5%	P: Rectangular	✓	C: UK BS 1363 (Type G)	✓
B: Jet Black	✓			40: 4000K	✓			D: Wieland	ⓘ
H: Anodic Champagne	+10%			65: 6500K	+5%			E: WAGO	ⓘ
R: Special RAL/NCS Colours	ⓘ								

✓ standard / no extra charge ⓘ on request ✗ not available

Cubic Evolution F5/F6 | Floor

catalogue page 110



F5 Symmetrical Stand, Rectangular Base

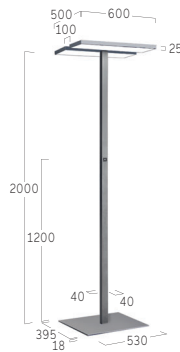

F6 Asymmetrical Stand, U- Cut Out

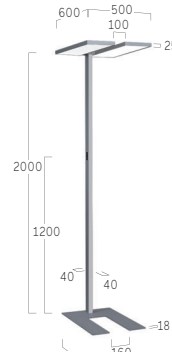

F6 Asymmetrical Stand, Side Cut Out



F5 Microprismatic | Direct-Indirect

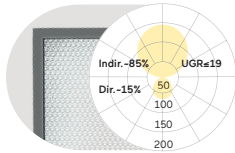

Control Gear	Colour Temperature	Power	Lumen/Watt	Weight kg	Code Snow White	Code Silver Anodised	CHF
Separately Dimmable	4000K	Medium	11500lm/88W	19,5	CF5AWX-840M-L600-P-A	CF5AEX-840M-L600-P-A	1626,00
Multisensor	4000K	Medium	11500lm/88W	19,5	CF5AWM-840M-L600-P-A	CF5AEM-840M-L600-P-A	2221,00
Swarm Control	4000K	Medium	11500lm/88W	19,5	CF5AWR-840M-L600-P-A	CF5AER-840M-L600-P-A	2361,00
Separately Dimmable	4000K	High	15500lm/114W	19,5	CF5AWX-840H-L600-P-A	CF5AEX-840H-L600-P-A	1714,00
Multisensor	4000K	High	15500lm/114W	19,5	CF5AWM-840H-L600-P-A	CF5AEM-840H-L600-P-A	2309,00
Swarm Control	4000K	High	15500lm/114W	19,5	CF5AWR-840H-L600-P-A	CF5AER-840H-L600-P-A	2449,00

F6 Microprismatic | Direct-Indirect

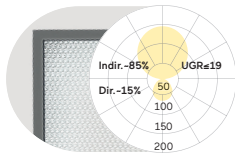

Control Gear	Colour Temperature	Power	Lumen/Watt	Weight kg	Code Snow White	Code Silver Anodised	CHF
Separately Dimmable	4000K	Medium	11500lm/88W	24,3	CF6AWX-840M-L600-U-A	CF6AEX-840M-L600-U-A	1626,00
Multisensor	4000K	Medium	11500lm/88W	24,3	CF6AWM-840M-L600-U-A	CF6AEM-840M-L600-U-A	2221,00
Swarm Control	4000K	Medium	11500lm/88W	24,3	CF6AWR-840M-L600-U-A	CF6AER-840M-L600-U-A	2361,00
Separately Dimmable	4000K	High	15500lm/114W	24,3	CF6AWX-840H-L600-U-A	CF6AEX-840H-L600-U-A	1714,00
Multisensor	4000K	High	15500lm/114W	24,3	CF6AWM-840H-L600-U-A	CF6AEM-840H-L600-U-A	2309,00
Swarm Control	4000K	High	15500lm/114W	24,3	CF6AWR-840H-L600-U-A	CF6AER-840H-L600-U-A	2449,00

Surcharges

Surface Finish	CHF	Colour Rendering	CHF	Colour Temperature	CHF	Base	CHF	Plug	CHF
W: Snow White	✓	8: CRI>80	✓	27: 2700K	+5%	S: Side Cut-Out (F6 only)	✓	A: Schuko CEE 7/7 (Type E+F)	✓
E: Silver Anodised	✓	9: CRI>90	+5%	30: 3000K	✓	U: U-Cut-Out (F6 only)	✓	B: CH T12 (Type J)	✓
U: Urban Graphite	✓	F: Full Spectrum	+15%	35: 3500K	+5%	P: Rectangular (F5 only)	✓	C: UK BS 1363 (Type G)	✓
B: Jet Black	✓			40: 4000K	✓			D: Wieland	ⓘ
H: Anodic Champagne	+10%			65: 6500K	+5%			E: WAGO	ⓘ
R: Special RAL/NCS Colours	ⓘ			TW: Tunable White 2700-6500K*	+30%				

*Only in combination with Dimmable control.

✓ standard / no extra charge ⓘ on request ✗ not available

Cubic Evolution F7 | Floor

catalogue page 112



Microprismatic | Direct-Indirect

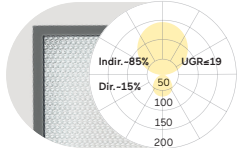

Control Gear	Colour Temperature	Power	Lumen/Watt	Weight kg	Code Snow White	Code Silver Anodised	CHF
Separately Dimmable	4000K	Medium	22200lm/136W	24,3	CF7AWX-840M-L1320-H-A	CF7AEX-840M-L1320-H-A	2779,00
Multisensor	4000K	Medium	22200lm/136W	24,3	CF7AWM-840M-L1320-H-A	CF7AEM-840M-L1320-H-A	3374,00
Swarm Control	4000K	Medium	22200lm/136W	24,3	CF7AWR-840M-L1320-H-A	CF7AER-840M-L1320-H-A	3514,00
Separately Dimmable	4000K	High	30600lm/184W	24,3	CF7AWX-840H-L1320-H-A	CF7AEX-840H-L1320-H-A	3129,00
Multisensor	4000K	High	30600lm/184W	24,3	CF7AWM-840H-L1320-H-A	CF7AEM-840H-L1320-H-A	3724,00
Swarm Control	4000K	High	30600lm/184W	24,3	CF7AWR-840H-L1320-H-A	CF7AER-840H-L1320-H-A	3864,00

Surcharges

Surface Finish

Surface Finish	CHF
W: Snow White	✓
E: Silver Anodised	✓
U: Urban Graphite	✓
B: Jet Black	✓
H: Anodic Champagne	+10%
R: Special RAL/NCS Colours	ⓘ

Colour Rendering

Colour Rendering	CHF
8: CRI>80	✓
9: CRI>90	+5%
F: Full Spectrum	+15%

Colour Temperature

Colour Temperature	CHF
27: 2700K	+5%
30: 3000K	✓
35: 3500K	+5%
40: 4000K	✓
65: 6500K	+5%
TW: Tunable White 2700-6500K*	+30%

Plug

Plug	CHF
A: Schuko CEE 7/7 (Type E+F)	✓
B: CH T12 (Type J)	✓
C: UK BS 1363 (Type G)	✓
D: Wieland	ⓘ
E: WAGO	ⓘ

*Only in combination with Dimmable control.

✓ standard / no extra charge ⓘ on request ✗ not available

Cubic Evolution F8 | Floor

catalogue page 114

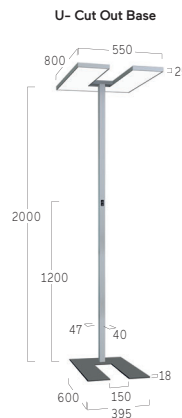

Microprismatic | Direct-Indirect

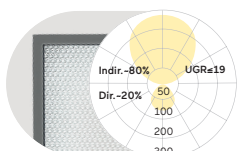

Control Gear	Colour Temperature	Power	Lumen/Watt	Weight kg	Code Snow White	Code Silver Anodised	CHF
Separately Dimmable	4000K	Medium	18100lm/119W	25,1	CF8AWX-840M-L800-U-A	CF8AEX-840M-L800-U-A	2274,00
Separately Dimmable	4000K	High	23900lm/155W	25,1	CF8AWX-840H-L800-U-A	CF8AEX-840H-L800-U-A	2387,00

Surcharges

Surface Finish

Surface Finish	CHF
W: Snow White	✓
E: Silver Anodised	✓
U: Urban Graphite	✓
B: Jet Black	✓
H: Anodic Champagne	+10%
R: Special RAL/NCS Colours	ⓘ

Colour Rendering

Colour Rendering	CHF
8: CRI>80	✓
9: CRI>90	+5%
F: Full Spectrum	+15%

Colour Temperature

Colour Temperature	CHF
27: 2700K	+5%
30: 3000K	✓
35: 3500K	+5%
40: 4000K	✓
65: 6500K	+5%

Plug

Plug	CHF
A: Schuko CEE 7/7 (Type E+F)	✓
B: CH T12 (Type J)	✓
C: UK BS 1363 (Type G)	✓
D: Wieland	ⓘ
E: WAGO	ⓘ

✓ standard / no extra charge ⓘ on request ✗ not available

Matric SX | System 40mm Floor One Head

catalogue page 116

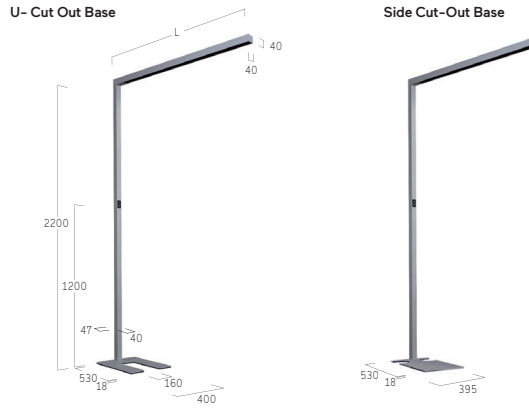

Lens Louvre | Direct-Indirect

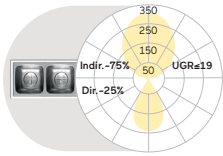

Control Gear	Colour Temperature	Power	Lumen/Watt	Weight kg	Code Snow White/Jet Black	Code Jet Black/Jet Black	CHF
Separately Dimmable	4000K	Medium	10300lm/85W	19,8	LSXLWX-840M-L1470-UB*-A	LSXLBX-840M-L1470-UB*-A	1976,00
Multisensor	4000K	Medium	10300lm/85W	23,8	LSXLWM-840M-L1570-UB*-A	LSXLBM-840M-L1570-UB*-A	2274,00
Swarm Control	4000K	Medium	10300lm/85W	23,8	LSXLWR-840M-L1570-UB*-A	LSXLBW-840M-L1570-UB*-A	2414,00
HCL	Tunable White	Medium	4900lm/43W	23,8	LSXLWB-8TWM-L1570-UB*-A	LSXLBW-8TWM-L1570-UB*-A	2624,00

Microprismatic | Direct-Indirect

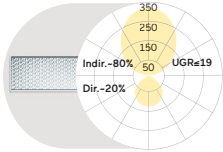

Control Gear	Colour Temperature	Power	Lumen/Watt	Weight kg	Code Snow White	Code Radiant Silver	CHF
Separately Dimmable	4000K	Medium	10000lm/96W	19,8	LSXAWX-840M-L1470-U-A	LSXASX-840M-L1470-U-A	1819,00
Multisensor	4000K	Medium	10000lm/96W	23,8	LSXAWM-840M-L1570-U-A	LSXASM-840M-L1570-U-A	2116,00
Swarm Control	4000K	Medium	10000lm/96W	23,8	LSXAWR-840M-L1570-U-A	LSXASR-840M-L1570-U-A	2256,00

Surcharges

Surface Finish	CHF	Colour Rendering	CHF	Colour Temperature	CHF	Lens Louvre*	CHF	Base	CHF
W: Snow White	✓	8: CRI>80	✓	22: 2200K	+5%	W: Snow White	✓	S: Side Cut-Out	✓
V: Ivory White	✓	9: CRI>90	+5%	27: 2700K	+5%	A: Satin Silver	✓	U: U-Cut-Out	✓
A: Satin Silver	+15%	F: Full Spectrum	+15%	30: 3000K	✓	B: Jet Black	✓	Plug	CHF
S: Radiant Silver	✓			35: 3500K	+5%	H: Anodic Champagne	✓	A: Schuko CEE 7/7 (Type E+F)	✓
U: Urban Graphite	✓			40: 4000K	✓	K: Satin Copper	✓	B: CH T12 (Type J)	✓
B: Jet Black	✓			65: 6500K	+5%	G: Satin Gold	✓	C: UK BS 1363 (Type G)	✓
H: Anodic Champagne	+10%							D: Wieland	⚡
K: Satin Copper	+15%							E: WAGO	⚡
R: Special RAL/NCS Colours	⚡								

✓ standard / no extra charge ⚡ on request ✗ not available

Matric SY | System 40mm Floor Two Heads

catalogue page 118

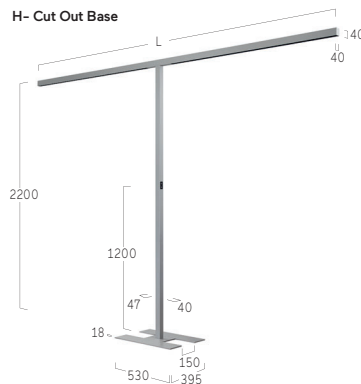

Lens Louvre | Direct-Indirect

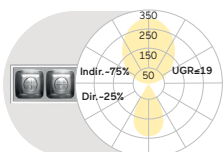

Control Gear	Colour Temperature	Power	Lumen/Watt	Weight kg	Code Snow White/Jet Black	Code Jet Black/Jet Black	CHF
Separately Dimmable	4000K	Medium	20600lm/170W	23,3	LSYLWX-840M-L2900-HB*-A	LSYLBX-840M-L2900-HB*-A	3847,00
Multisensor	4000K	Medium	20600lm/170W	23,8	LSYLWM-840M-L3100-HB*-A	LSYLBW-840M-L3100-HB*-A	4442,00
Swarm Control	4000K	Medium	20600lm/170W	23,8	LSYLWR-840M-L3100-HB*-A	LSYLBW-840M-L3100-HB*-A	4582,00

... Matric SY | System 40mm Floor Two Heads

Microprismatic | Direct-Indirect

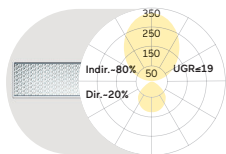

Control Gear	Colour Temperature	Power	Lumen/Watt	Weight kg	Code Snow White	Code Radiant Silver	CHF
Separately Dimmable	4000K	Medium	20000lm/192W	23,3	LSYAWX-840M-L2900-H-A	LSYASX-840M-L2900-H-A	3532,00
Multisensor	4000K	Medium	20000lm/192W	23,8	LSYAWM-840M-L3100-H-A	LSYASM-840M-L3100-H-A	4127,00
Swarm Control	4000K	Medium	20000lm/192W	23,8	LSYAWR-840M-L3100-H-A	LSYASR-840M-L3100-H-A	4267,00

Surcharges

Surface Finish	CHF	Colour Rendering	CHF	Colour Temperature	CHF	Lens Louvre*	CHF	Plug	CHF
W: Snow White	✓	8: CRI>80	✓	27: 2700K	+5%	W: Snow White	✓	A: Schuko CEE 7/7 (Type E+F)	✓
V: Ivory White	✓	9: CRI>90	+5%	30: 3000K	✓	A: Satin Silver	✓	B: CH T12 (Type J)	✓
A: Satin Silver	+15%	F: Full Spectrum	+15%	35: 3500K	+5%	B: Jet Black	✓	C: UK BS 1363 (Type G)	✓
S: Radiant Silver	✓			40: 4000K	✓	H: Anodic Champagne	✓	D: Wieland	ⓘ
U: Urban Graphite	✓			65: 6500K	+5%	K: Satin Copper	✓	E: WAGO	ⓘ
B: Jet Black	✓			TW: Tunable White 2700-6500K*	+30%	G: Satin Gold	✓		
H: Anodic Champagne	+10%								
K: Satin Copper	+15%								
R: Special RAL/NCS Colours	ⓘ								

*Only in combination with Dimmable control.

✓ standard / no extra charge ⓘ on request ✗ not available

Wand | Wall | Applique



Lucille W1 |
Wall
34



Midpin W2 |
Wall
34



Midpoint W7 |
Wall
35

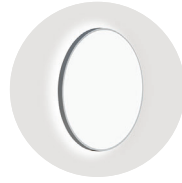

Basic Superflat X7/Y7 |
Wall
35



Basic Neo W5 |
Wall
36



Basic Neo Y5/X5 |
Wall
37



Basic Déco Y3/X3 |
Wall
38



Basic Visio Y9/X9 |
Wall
39



Liquid Line Compact
W5 | Wall
40



Liquid Line WX |
System 40mm Wall
40



Caleo Neo Y6/X6 |
Wall
41



Cubic Evolution W4 |
Wall
42



Cubic Evolution Y6/X6 |
Wall
43

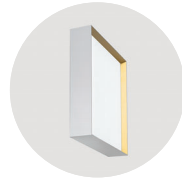

Cubic Déco A3 |
Wall
44

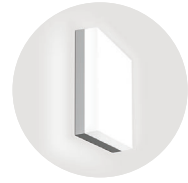

Cubic Ambient A7 |
Wall
45



Matric Ambient AX |
System 40mm Wall
45



Matric WX |
System 40mm Wall
46

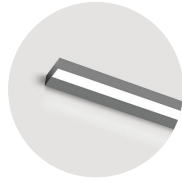

Matric DX |
System 40mm Wall
47

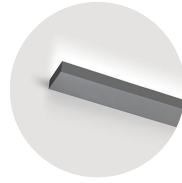

Matric JX |
System 40mm Wall
47

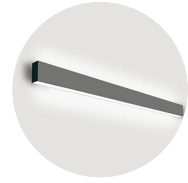

Matric W4 |
System 55mm Wall
48



Matric W6 |
System 81mm Wall
49

Wand | Wall | Applique

Lucille W1 | Wall

catalogue page 124



Microprismatic | Direct

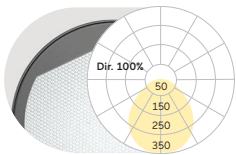

Control Gear	Colour Temperature	Power	Lumen/Watt	Weight kg	Code Ivory White	Code Jet Black	CHF
Switch & Dim	4000K	Medium	1000lm/13W	2,5	UW1AVS-840M-D150-C	UW1ABS-840M-D150-C	576,00

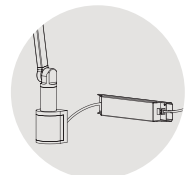
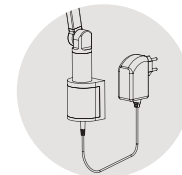

Power Supply with cord

Power Supply through the wall

Surcharges

Surface Finish	CHF	Colour Rendering	CHF	Colour Temperature	CHF	Power Supply	CHF
V: Ivory White	✓	8: CRI>80	✓	22: 2200K	+5%	C: With Cord	✓
A: Satin Silver	+15%	9: CRI>90	+5%	27: 2700K	+5%	W: Through the Wall	✓
B: Jet Black	✓	F: Full Spectrum	+15%	30: 3000K	✓		
H: Anodic Champagne	+10%			35: 3500K	+5%		
R: Special RAL/NCS Colours	ⓘ			40: 4000K	✓		
				65: 6500K	+5%		

✓ standard / no extra charge ⓘ on request ✗ not available

Midpin W2 | Wall

catalogue page 126

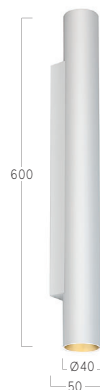

Led Engine - Eco:

Beam Angle	Colour Temperature	Control	Power	Lumen/Watt	Weight kg	Code Snow White	Code Jet Black	CHF
Medium 30°	4000K	On/Off	Medium	1500lm/22W	0,5	DW2BWE-940M-W	DW2BBE-940M-B	569,00
Flood 40°	4000K	On/Off	Medium	1540lm/22W	0,5	DW2CWE-940M-W	DW2CBE-940M-B	569,00

Surcharges

Surface / Reflector Finish	CHF	Control Gear	CHF	Colour Temperature	CHF	Optic Ring	CHF
W: Snow White	✓	E: On/Off	✓	27: 2700K	+5%	W: Snow White	✓
V: Ivory White	✓	L: DALI	+86,00	30: 3000K	✓	V: Ivory White	✓
A: Satin Silver	+15%	H: Touch-Dim	+86,00	35: 3500K	+5%	A: Satin Silver	✓
B: Jet Black	✓			40: 4000K	✓	B: Jet Black	✓
H: Anodic Champagne	+10%			DW: Dim to Warm 3000K-1800K*	+15%	H: Anodic Champagne	✓
R: Special RAL/NCS Colours	ⓘ					K: Satin Copper	✓
						G: Satin Gold	✓

*Only in combination with DALI. Please add to dimming price.

✓ standard / no extra charge ⓘ on request ✗ not available

Midpoint Wall | W7

catalogue page 128

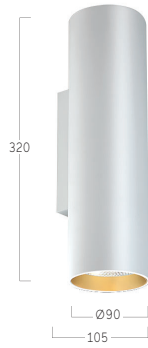

Led Engine - Eco:

Beam Angle	Colour Temperature	Control	Power	Lumen/Watt	Weight kg	Code Snow White	Code Radiant Silver	CHF
Spot 10°	4000K	On/Off	Low	2160lm/27W	1,7	PW7AWE-940FE-WK	PW7ASE-940FE-SK	622,00
Spot 10°	4000K	On/Off	Medium	2880lm/39W	1,7	PW7AWE-940FM-WK	PW7ASE-940FM-SK	622,00
Medium 20°	4000K	On/Off	Low	2820lm/27W	1,7	PW7BWE-940FE-WK	PW7BSE-940FE-SK	622,00
Medium 20°	4000K	On/Off	Medium	3700lm/39W	1,7	PW7BWE-940FM-WK	PW7BSE-940FM-SK	622,00
Flood 35°	4000K	On/Off	Low	2760lm/27W	1,7	PW7CWE-940FE-WK	PW7CSE-940FE-SK	622,00
Flood 35°	4000K	On/Off	Medium	3580lm/39W	1,7	PW7CWE-940FM-WK	PW7CSE-940FM-SK	622,00
W Flood 50°	4000K	On/Off	Low	2680lm/27W	1,7	PW7DWE-940FE-WK	PW7DSE-940FE-SK	622,00
W Flood 50°	4000K	On/Off	Medium	3360lm/39W	1,7	PW7DWE-940FM-WK	PW7DSE-940FM-SK	622,00

Led Engine - Artist Xicato:

Beam Angle	Colour Temperature	Control	Power	Lumen/Watt	Weight kg	Code Snow White	Code Radiant Silver	CHF
Spot 10°	4000K	On/Off	Low	1780lm/26W	1,7	PW7AWE-940AE-WK	PW7ASE-940AE-SK	727,00
Spot 10°	4000K	On/Off	Medium	2380lm/38W	1,7	PW7AWE-940AM-WK	PW7ASE-940AM-SK	727,00
Medium 20°	4000K	On/Off	Low	2300lm/26W	1,7	PW7BWE-940AE-WK	PW7BSE-940AE-SK	727,00
Medium 20°	4000K	On/Off	Medium	3020lm/38W	1,7	PW7BWE-940AM-WK	PW7BSE-940AM-SK	727,00
Flood 35°	4000K	On/Off	Low	2260lm/26W	1,7	PW7CWE-940AE-WK	PW7CSE-940AE-SK	727,00
Flood 35°	4000K	On/Off	Medium	2940lm/38W	1,7	PW7CWE-940AM-WK	PW7CSE-940AM-SK	727,00
W Flood 50°	4000K	On/Off	Low	2280lm/26W	1,7	PW7DWE-940AE-WK	PW7DSE-940AE-SK	727,00
W Flood 50°	4000K	On/Off	Medium	2860lm/38W	1,7	PW7DWE-940AM-WK	PW7DSE-940AM-SK	727,00

Surcharges

Surface / Reflector Finish	CHF	Control Gear	CHF	Colour Temperature	CHF	Optic Ring	CHF	Cover	CHF
W: Snow White	✓	E: On/Off	✓	27: 2700K	+5%	W: Snow White	✓	K: Clear Cover	✓
V: Ivory White	✓	L: DALI	+86,00	30: 3000K	✓	V: Ivory White	✓	P: Prismatic Lens	+21,00
S: Radiant Silver	✓	H: Touch-Dim	+86,00	40: 4000K	✓	S: Radiant Silver	✓	H: Honeycomb Louvre	+21,00
B: Jet Black	✓					B: Jet Black	✓	Additional Options	CHF
H: Anodic Champagne	+10%					H: Anodic Champagne	✓	Optic Removal Tool	34,00
R: Special RAL/NCS Colours	ⓘ					K: Satin Copper	✓		
						G: Satin Gold	✓		

✓ standard / no extra charge
 ⓘ on request
 ✗ not available

Basic Superflat X7/Y7 | Wall

catalogue page 130



Microprismatic | Direct-Indirect

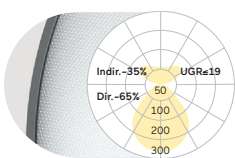

D mm	Colour Temperature	Control	Power	Lumen/Watt	Weight kg	Code Snow White	Code Radiant Silver	CHF
300	4000K	On/Off	Medium	1260lm/11W	2,0	BX7AWE-840M-D300	BX7ASE-840M-D300	818,00
300	4000K	On/Off	High	2150lm/18W	2,0	BX7AWE-840H-D300	BX7ASE-840H-D300	818,00
400	4000K	On/Off	Medium	2330lm/18W	3,5	BX7AWE-840M-D400	BX7ASE-840M-D400	1075,00
400	4000K	On/Off	High	4050lm/31W	3,5	BX7AWE-840H-D400	BX7ASE-840H-D400	1075,00
500	4000K	On/Off	Medium	3000lm/23W	5,1	BX7AWE-840M-D500	BX7ASE-840M-D500	1294,00
500	4000K	On/Off	High	5240lm/40W	5,1	BX7AWE-840H-D500	BX7ASE-840H-D500	1294,00
600	4000K	On/Off	Medium	5380lm/40W	6,9	BX7AWE-840M-D600	BX7ASE-840M-D600	1642,00
600	4000K	On/Off	High	8270lm/63W	6,9	BX7AWE-840H-D600	BX7ASE-840H-D600	1642,00
800	4000K	On/Off	Medium	7860lm/60W	11,9	BX7AWE-840M-D800	BX7ASE-840M-D800	2818,00
800	4000K	On/Off	High	10750lm/81W	11,9	BX7AWE-840H-D800	BX7ASE-840H-D800	2818,00

... Basic Superflat X7/Y7 | Wall

Microprismatic | Direct

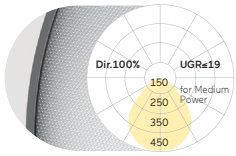

D mm	Colour Temperature	Control	Power	Lumen/Watt	Weight kg	Code Snow White	Code Radiant Silver	CHF
300	4000K	On/Off	Medium	690lm/7W	1,9	BY7AWE-840M-D300	BY7ASE-840M-D300	678,00
300	4000K	On/Off	High	1190lm/11W	1,9	BY7AWE-840H-D300	BY7ASE-840H-D300	678,00
400	4000K	On/Off	Medium	1470lm/12W	3,3	BY7AWE-840M-D400	BY7ASE-840M-D400	917,00
400	4000K	On/Off	High	2560lm/21W	3,3	BY7AWE-840H-D400	BY7ASE-840H-D400	917,00
500	4000K	On/Off	Medium	2030lm/16W	4,9	BY7AWE-840M-D500	BY7ASE-840M-D500	1119,00
500	4000K	On/Off	High	3570lm/28W	4,9	BY7AWE-840H-D500	BY7ASE-840H-D500	1119,00
600	4000K	On/Off	Medium	3390lm/25W	6,8	BY7AWE-840M-D600	BY7ASE-840M-D600	1449,00
600	4000K	On/Off	High	5520lm/42W	6,8	BY7AWE-840H-D600	BY7ASE-840H-D600	1449,00
800	4000K	On/Off	Medium	5160lm/40W	11,4	BY7AWE-840M-D800	BY7ASE-840M-D800	2608,00
800	4000K	On/Off	High	6980lm/54W	11,4	BY7AWE-840H-D800	BY7ASE-840H-D800	2608,00

Opal Diffuser | Direct-Indirect

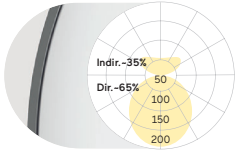

D mm	Colour Temperature	Control	Power	Lumen/Watt	Weight kg	Code Snow White	Code Radiant Silver	CHF
300	4000K	On/Off	Medium	1270lm/11W	2,0	BX7OWE-840M-D300	BX7OSE-840M-D300	781,00
300	4000K	On/Off	High	2160lm/18W	2,0	BX7OWE-840H-D300	BX7OSE-840H-D300	781,00
400	4000K	On/Off	Medium	2350lm/18W	3,5	BX7OWE-840M-D400	BX7OSE-840M-D400	1019,00
400	4000K	On/Off	High	4070lm/31W	3,5	BX7OWE-840H-D400	BX7OSE-840H-D400	1019,00
500	4000K	On/Off	Medium	3040lm/23W	5,1	BX7OWE-840M-D500	BX7OSE-840M-D500	1239,00
500	4000K	On/Off	High	5300lm/40W	5,1	BX7OWE-840H-D500	BX7OSE-840H-D500	1239,00
600	4000K	On/Off	Medium	5450lm/40W	6,9	BX7OWE-840M-D600	BX7OSE-840M-D600	1568,00
600	4000K	On/Off	High	8370lm/63W	6,9	BX7OWE-840H-D600	BX7OSE-840H-D600	1568,00
800	4000K	On/Off	Medium	7980lm/60W	11,9	BX7OWE-840M-D800	BX7OSE-840M-D800	2744,00
800	4000K	On/Off	High	10920lm/81W	11,9	BX7OWE-840H-D800	BX7OSE-840H-D800	2744,00

Opal Diffuser | Direct

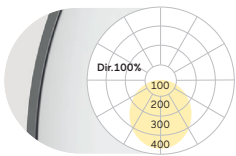

D mm	Colour Temperature	Control	Power	Lumen/Watt	Weight kg	Code Snow White	Code Radiant Silver	CHF
300	4000K	On/Off	Medium	700lm/7W	1,9	BY7OWE-840M-D300	BY7OSE-840M-D300	641,00
300	4000K	On/Off	High	1200lm/11W	1,9	BY7OWE-840H-D300	BY7OSE-840H-D300	641,00
400	4000K	On/Off	Medium	1490lm/12W	3,3	BY7OWE-840M-D400	BY7OSE-840M-D400	861,00
400	4000K	On/Off	High	2580lm/21W	3,3	BY7OWE-840H-D400	BY7OSE-840H-D400	861,00
500	4000K	On/Off	Medium	2070lm/16W	4,9	BY7OWE-840M-D500	BY7OSE-840M-D500	1064,00
500	4000K	On/Off	High	3630lm/28W	4,9	BY7OWE-840H-D500	BY7OSE-840H-D500	1064,00
600	4000K	On/Off	Medium	3460lm/25W	6,8	BY7OWE-840M-D600	BY7OSE-840M-D600	1376,00
600	4000K	On/Off	High	5620lm/42W	6,8	BY7OWE-840H-D600	BY7OSE-840H-D600	1376,00
800	4000K	On/Off	Medium	5280lm/40W	11,4	BY7OWE-840M-D800	BY7OSE-840M-D800	2534,00
800	4000K	On/Off	High	7150lm/54W	11,4	BY7OWE-840H-D800	BY7OSE-840H-D800	2534,00

Surcharges

Surface Finish	CHF	Control Gear	CHF	Colour Rendering	CHF	Colour Temperature	CHF	Additional Options	CHF	
W: Snow White	✓	E: On/Off	✓	8: CRI>80	✓	22: 2200K	+5%	Emergency Module [DALI, Autotest, incl. 3H Battery] [D400-D800]	+366,00	
V: Ivory White	✓	L: DALI	+86,00	9: CRI>90	+5%	27: 2700K	+5%			
S: Radiant Silver	✓	H: Touch-Dim	+86,00	F: Full Spectrum	+15%	30: 3000K	✓			
U: Urban Graphite	✓	C: Casambi*	+261,00			35: 3500K	+5%			
B: Jet Black	✓	6: DALI DT6 for TW	+172,00			40: 4000K	✓			
H: Anodic Champagne	+10%	8: DALI DT8 for TW	+172,00			65: 6500K	+5%			
K: Satin Copper	+15%					TW: Tunable White 2700-6500K*	+30%			
R: Special RAL/NCS Colours	ⓘ									
	✓	*Only in combination with DALI. Please add to dimming price.								
	ⓘ									
	✗									

*Only in combination with DT6, DT8 or Casambi control. Please add additional control price.

Basic Neo W5 | Wall

catalogue page 132

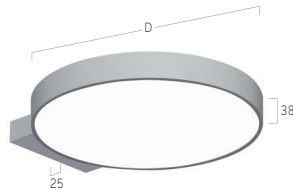

Microprismatic | Direct-Indirect

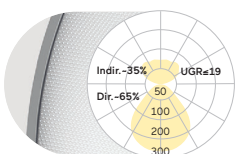

D mm	Colour Temperature	Control	Power	Lumen/Watt	Weight kg	Code Snow White	Code Radiant Silver	CHF
300	4000K	On/Off	Medium	1210lm/11W	3,0	BW5AWE-840M-D300	BW5ASE-840M-D300	872,00
300	4000K	On/Off	High	2070lm/18W	3,0	BW5AWE-840H-D300	BW5ASE-840H-D300	872,00

Opal Diffuser | Direct-Indirect

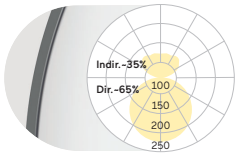

D mm	Colour Temperature	Control	Power	Lumen/Watt	Weight kg	Code Snow White	Code Radiant Silver	CHF
300	4000K	On/Off	Medium	1220lm/11W	3,0	BW5OWE-840M-D300	BW5OSE-840M-D300	832,00
300	4000K	On/Off	High	2080lm/18W	3,0	BW5OWE-840H-D300	BW5OSE-840H-D300	832,00

Surcharges

Surface Finish

Surface Finish	CHF
W: Snow White	✓
V: Ivory White	✓
S: Radiant Silver	✓
U: Urban Graphite	✓
B: Jet Black	✓
H: Anodic Champagne	+10%
K: Satin Copper	+15%
R: Special RAL/NCS Colours	📌

Control Gear

Control Gear	CHF
E: On/Off	✓
L: DALI	+86,00
H: Touch-Dim	+86,00

Colour Rendering

Colour Rendering	CHF
8: CRI>80	✓
9: CRI>90	+5%
F: Full Spectrum	+15%

Colour Temperature

Colour Temperature	CHF
22: 2200K	+5%
27: 2700K	+5%
30: 3000K	✓
35: 3500K	+5%
40: 4000K	✓
65: 6500K	+5%

✓ standard / no extra charge 📌 on request ✗ not available

Basic Neo Y5/X5 | Wall

catalogue page 134



Microprismatic | Direct-Indirect

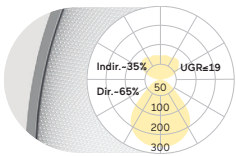

D mm	Colour Temperature	Control	Power	Lumen/Watt	Weight kg	Code Snow White	Code Radiant Silver	CHF
300	4000K	On/Off	Medium	1210lm/11W	2,2	BX5AWE-840M-D300	BX5ASE-840M-D300	781,00
300	4000K	On/Off	High	2070lm/18W	2,2	BX5AWE-840H-D300	BX5ASE-840H-D300	781,00
400	4000K	On/Off	Medium	2260lm/18W	3,7	BX5AWE-840M-D400	BX5ASE-840M-D400	1014,00
400	4000K	On/Off	High	3920lm/31W	3,7	BX5AWE-840H-D400	BX5ASE-840H-D400	1014,00
500	4000K	On/Off	Medium	2920lm/23W	5,4	BX5AWE-840M-D500	BX5ASE-840M-D500	1227,00
500	4000K	On/Off	High	5100lm/40W	5,4	BX5AWE-840H-D500	BX5ASE-840H-D500	1227,00
600	4000K	On/Off	Medium	5210lm/40W	7,2	BX5AWE-840M-D600	BX5ASE-840M-D600	1565,00
600	4000K	On/Off	High	8040lm/63W	7,2	BX5AWE-840H-D600	BX5ASE-840H-D600	1565,00
800	4000K	On/Off	Medium	7630lm/60W	11,8	BX5AWE-840M-D800	BX5ASE-840M-D800	2708,00
800	4000K	On/Off	High	10430lm/81W	11,8	BX5AWE-840H-D800	BX5ASE-840H-D800	2708,00

Microprismatic | Direct

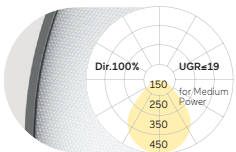

D mm	Colour Temperature	Control	Power	Lumen/Watt	Weight kg	Code Snow White	Code Radiant Silver	CHF
300	4000K	On/Off	Medium	690lm/7W	2,0	BY5AWE-840M-D300	BY5ASE-840M-D300	727,00
300	4000K	On/Off	High	1190lm/11W	2,0	BY5AWE-840H-D300	BY5ASE-840H-D300	727,00
400	4000K	On/Off	Medium	1470lm/12W	3,4	BY5AWE-840M-D400	BY5ASE-840M-D400	942,00
400	4000K	On/Off	High	2560lm/21W	3,4	BY5AWE-840H-D400	BY5ASE-840H-D400	942,00
500	4000K	On/Off	Medium	2030lm/16W	5,0	BY5AWE-840M-D500	BY5ASE-840M-D500	1138,00
500	4000K	On/Off	High	3570lm/28W	5,0	BY5AWE-840H-D500	BY5ASE-840H-D500	1138,00
600	4000K	On/Off	Medium	3390lm/25W	6,7	BY5AWE-840M-D600	BY5ASE-840M-D600	1458,00
600	4000K	On/Off	High	5520lm/42W	6,7	BY5AWE-840H-D600	BY5ASE-840H-D600	1458,00
800	4000K	On/Off	Medium	5160lm/40W	11,1	BY5AWE-840M-D800	BY5ASE-840M-D800	2583,00
800	4000K	On/Off	High	6980lm/54W	11,1	BY5AWE-840H-D800	BY5ASE-840H-D800	2583,00

Opal Diffuser | Direct-Indirect

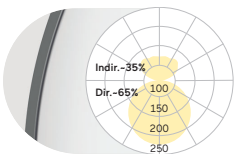

D mm	Colour Temperature	Control	Power	Lumen/Watt	Weight kg	Code Snow White	Code Radiant Silver	CHF
300	4000K	On/Off	Medium	1220lm/11W	2,2	BX5OWE-840M-D300	BX5OSE-840M-D300	746,00
300	4000K	On/Off	High	2080lm/18W	2,2	BX5OWE-840H-D300	BX5OSE-840H-D300	746,00
400	4000K	On/Off	Medium	2280lm/18W	3,7	BX5OWE-840M-D400	BX5OSE-840M-D400	959,00
400	4000K	On/Off	High	3940lm/31W	3,7	BX5OWE-840H-D400	BX5OSE-840H-D400	959,00
500	4000K	On/Off	Medium	2960lm/23W	5,4	BX5OWE-840M-D500	BX5OSE-840M-D500	1173,00
500	4000K	On/Off	High	5160lm/40W	5,4	BX5OWE-840H-D500	BX5OSE-840H-D500	1173,00
600	4000K	On/Off	Medium	5280lm/40W	7,2	BX5OWE-840M-D600	BX5OSE-840M-D600	1416,00
600	4000K	On/Off	High	8140lm/63W	7,2	BX5OWE-840H-D600	BX5OSE-840H-D600	1416,00
800	4000K	On/Off	Medium	7750lm/60W	11,8	BX5OWE-840M-D800	BX5OSE-840M-D800	2606,00
800	4000K	On/Off	High	10600lm/81W	11,8	BX5OWE-840H-D800	BX5OSE-840H-D800	2606,00

... Basic Neo Y5/X5 | Wall

Opal Diffuser | Direct

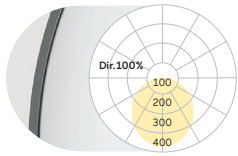

D mm	Colour Temperature	Control	Power	Lumen/Watt	Weight kg	Code Snow White	Code Radiant Silver	CHF
300	4000K	On/Off	Medium	700lm/7W	2,0	BY5OWE-840M-D300	BY5OSE-840M-D300	692,00
300	4000K	On/Off	High	1200lm/11W	2,0	BY5OWE-840H-D300	BY5OSE-840H-D300	692,00
400	4000K	On/Off	Medium	1490lm/12W	3,4	BY5OWE-840M-D400	BY5OSE-840M-D400	888,00
400	4000K	On/Off	High	2580lm/21W	3,4	BY5OWE-840H-D400	BY5OSE-840H-D400	888,00
500	4000K	On/Off	Medium	2070lm/16W	5,0	BY5OWE-840M-D500	BY5OSE-840M-D500	1084,00
500	4000K	On/Off	High	3630lm/28W	5,0	BY5OWE-840H-D500	BY5OSE-840H-D500	1084,00
600	4000K	On/Off	Medium	3460lm/25W	6,7	BY5OWE-840M-D600	BY5OSE-840M-D600	1309,00
600	4000K	On/Off	High	5620lm/42W	6,7	BY5OWE-840H-D600	BY5OSE-840H-D600	1309,00
800	4000K	On/Off	Medium	5280lm/40W	11,1	BY5OWE-840M-D800	BY5OSE-840M-D800	2482,00
800	4000K	On/Off	High	7150lm/54W	11,1	BY5OWE-840H-D800	BY5OSE-840H-D800	2482,00

Surcharges

Surface Finish	CHF	Control Gear	CHF	Colour Rendering	CHF	Colour Temperature	CHF	Additional Options	CHF
W: Snow White	✓	E: On/Off	✓	8: CRI>80	✓	22: 2200K	+5%	Emergency Module [DALI, Autotest, incl. 3H Battery] [D400-D800]	+366,00
V: Ivory White	✓	L: DALI	+86,00	9: CRI>90	+5%	27: 2700K	+5%		
S: Radiant Silver	✓	H: Touch-Dim	+86,00	F: Full Spectrum	+15%	30: 3000K	✓		
U: Urban Graphite	✓	C: Casambi*	+261,00			35: 3500K	+5%		
B: Jet Black	✓	6: DALI DT6 for TW	+172,00			40: 4000K	✓		
H: Anodic Champagne	+10%	8: DALI DT8 for TW	+172,00			65: 6500K	+5%		
K: Satin Copper	+15%					TW: Tunable White 2700-6500K*	+30%		
R: Special RAL/NCS Colours	🔴								

*Only in combination with DALI. Please add to dimming price.
 *Only in combination with DT6, DT8 or Casambi control. Please add additional control price.

✓ standard / no extra charge 🔴 on request ✗ not available

Basic Déco Y3/X3 | Wall

catalogue page 136

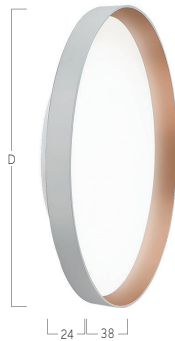

Microprismatic | Direct-Indirect

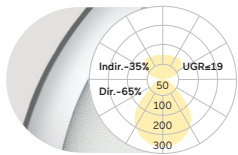

D mm	Colour Temperature	Control	Power	Lumen/Watt	Weight kg	Code Snow White	Code Radiant Silver	CHF
300	4000K	On/Off	Medium	1480lm/13W	2,3	BX3AWE-840M-D300-W	BX3ASE-840M-D300-S	821,00
300	4000K	On/Off	High	2530lm/23W	2,3	BX3AWE-840H-D300-W	BX3ASE-840H-D300-S	821,00
400	4000K	On/Off	Medium	2370lm/20W	4,0	BX3AWE-840M-D400-W	BX3ASE-840M-D400-S	1042,00
400	4000K	On/Off	High	3750lm/31W	4,0	BX3AWE-840H-D400-W	BX3ASE-840H-D400-S	1042,00
500	4000K	On/Off	Medium	3500lm/29W	5,6	BX3AWE-840M-D500-W	BX3ASE-840M-D500-S	1269,00
500	4000K	On/Off	High	5810lm/48W	5,6	BX3AWE-840H-D500-W	BX3ASE-840H-D500-S	1269,00
600	4000K	On/Off	Medium	5380lm/43W	7,5	BX3AWE-840M-D600-W	BX3ASE-840M-D600-S	1593,00
600	4000K	On/Off	High	7750lm/63W	7,5	BX3AWE-840H-D600-W	BX3ASE-840H-D600-S	1593,00
800	4000K	On/Off	Medium	7830lm/63W	12,2	BX3AWE-840M-D800-W	BX3ASE-840M-D800-S	2799,00
800	4000K	On/Off	High	9940lm/82W	12,2	BX3AWE-840H-D800-W	BX3ASE-840H-D800-S	2799,00

Microprismatic | Direct

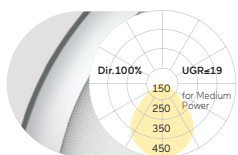

D mm	Colour Temperature	Control	Power	Lumen/Watt	Weight kg	Code Snow White	Code Radiant Silver	CHF
300	4000K	On/Off	Medium	830lm/8W	2,1	BY3AWE-840M-D300-W	BY3ASE-840M-D300-S	767,00
300	4000K	On/Off	High	1430lm/13W	2,1	BY3AWE-840H-D300-W	BY3ASE-840H-D300-S	767,00
400	4000K	On/Off	Medium	1500lm/14W	3,7	BY3AWE-840M-D400-W	BY3ASE-840M-D400-S	970,00
400	4000K	On/Off	High	2410lm/21W	3,7	BY3AWE-840H-D400-W	BY3ASE-840H-D400-S	970,00
500	4000K	On/Off	Medium	2370lm/21W	5,2	BY3AWE-840M-D500-W	BY3ASE-840M-D500-S	1180,00
500	4000K	On/Off	High	3980lm/35W	5,2	BY3AWE-840H-D500-W	BY3ASE-840H-D500-S	1180,00
600	4000K	On/Off	Medium	3560lm/28W	7,0	BY3AWE-840M-D600-W	BY3ASE-840M-D600-S	1486,00
600	4000K	On/Off	High	5230lm/42W	7,0	BY3AWE-840H-D600-W	BY3ASE-840H-D600-S	1486,00
800	4000K	On/Off	Medium	5360lm/44W	11,5	BY3AWE-840M-D800-W	BY3ASE-840M-D800-S	2674,00
800	4000K	On/Off	High	6490lm/55W	11,5	BY3AWE-840H-D800-W	BY3ASE-840H-D800-S	2674,00

Opal Diffuser | Direct-Indirect

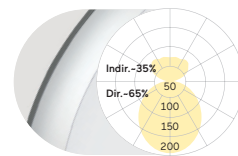

D mm	Colour Temperature	Control	Power	Lumen/Watt	Weight kg	Code Snow White	Code Radiant Silver	CHF
300	4000K	On/Off	Medium	1460lm/13W	2,3	BX3OWE-840M-D300-W	BX3OSE-840M-D300-S	786,00
300	4000K	On/Off	High	2500lm/23W	2,3	BX3OWE-840H-D300-W	BX3OSE-840H-D300-S	786,00
400	4000K	On/Off	Medium	2370lm/20W	4,0	BX3OWE-840M-D400-W	BX3OSE-840M-D400-S	989,00
400	4000K	On/Off	High	3750lm/31W	4,0	BX3OWE-840H-D400-W	BX3OSE-840H-D400-S	989,00
500	4000K	On/Off	Medium	3520lm/29W	5,6	BX3OWE-840M-D500-W	BX3OSE-840M-D500-S	1199,00
500	4000K	On/Off	High	5870lm/48W	5,6	BX3OWE-840H-D500-W	BX3OSE-840H-D500-S	1199,00
600	4000K	On/Off	Medium	5470lm/43W	7,5	BX3OWE-840M-D600-W	BX3OSE-840M-D600-S	1444,00
600	4000K	On/Off	High	7850lm/63W	7,5	BX3OWE-840H-D600-W	BX3OSE-840H-D600-S	1444,00
800	4000K	On/Off	Medium	7980lm/63W	12,2	BX3OWE-840M-D800-W	BX3OSE-840M-D800-S	2659,00
800	4000K	On/Off	High	10110lm/82W	12,2	BX3OWE-840H-D800-W	BX3OSE-840H-D800-S	2659,00

Opal Diffuser | Direct

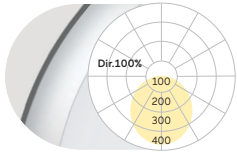

D mm	Colour Temperature	Control	Power	Lumen/Watt	Weight kg	Code Snow White	Code Radiant Silver	CHF
300	4000K	On/Off	Medium	810lm/8W	2,1	BY3OWE-840M-D300-W	BY3OSE-840M-D300-S	732,00
300	4000K	On/Off	High	1400lm/13W	2,1	BY3OWE-840H-D300-W	BY3OSE-840H-D300-S	732,00
400	4000K	On/Off	Medium	1500lm/14W	3,7	BY3OWE-840M-D400-W	BY3OSE-840M-D400-S	917,00
400	4000K	On/Off	High	2410lm/21W	3,7	BY3OWE-840H-D400-W	BY3OSE-840H-D400-S	917,00
500	4000K	On/Off	Medium	2390lm/21W	5,2	BY3OWE-840M-D500-W	BY3OSE-840M-D500-S	1110,00
500	4000K	On/Off	High	4040lm/35W	5,2	BY3OWE-840H-D500-W	BY3OSE-840H-D500-S	1110,00
600	4000K	On/Off	Medium	3650lm/28W	7,0	BY3OWE-840M-D600-W	BY3OSE-840M-D600-S	1337,00
600	4000K	On/Off	High	5330lm/42W	7,0	BY3OWE-840H-D600-W	BY3OSE-840H-D600-S	1337,00
800	4000K	On/Off	Medium	5510lm/44W	11,5	BY3OWE-840M-D800-W	BY3OSE-840M-D800-S	2534,00
800	4000K	On/Off	High	6660lm/55W	11,5	BY3OWE-840H-D800-W	BY3OSE-840H-D800-S	2534,00

Surcharges

Surface / Reflector Finish

Uni-Colours

Surface / Reflector Finish	CHF
W...W: Snow White / Snow White	✓
V...V: Ivory White / Ivory White	✓
S...S: Radiant Silver / Radiant Silver	✓
U...U: Urban Graphite / Urban Graphite	✓
B...B: Jet Black / Jet Black	✓
H...H: Anodic Champ. / Anodic Champ.	+5%
K...K: Satin Copper / Satin Copper	+15%

Surface / Reflector Finish

Dual Colours

Surface / Reflector Finish	CHF
W...G: Snow White / Satin Gold	+15%
W...K: Snow White / Satin Copper	+15%
W...B: Snow White / Jet Black	+15%
H...B: Anodic Champagne / Jet Black	+15%
B...G: Jet Black / Satin Gold	+15%
B...W: Jet Black / Snow White	+15%

Colour Rendering	CHF
8: CRI>80	✓
9: CRI>90	+5%
F: Full Spectrum	+15%

Control Gear

Control Gear	CHF
E: On/Off	✓
L: DALI	+86,00
H: Touch-Dim	+86,00
C: Casambi*	+261,00
6: DALI DT6 for TW	+172,00
8: DALI DT8 for TW	+172,00

*Only in combination with DALI. Please add to dimming price.

Colour Temperature

Colour Temperature	CHF
22: 2200K	+5%
27: 2700K	+5%
30: 3000K	✓
35: 3500K	+5%
40: 4000K	✓
65: 6500K	+5%
TW: Tunable White 2700-6500K*	+30%

*Only in combination with DT6, DT8 or Casambi control. Please add additional control price.

Additional Options

Additional Options	CHF
Emergency Module [DALI, Autotest, incl. 3H Battery]	+366,00
[D400-D800]	

✓ standard / no extra charge ⚠ on request ✗ not available

Basic Visio Y9/X9 | Wall

catalogue page 138



Microprismatic | Direct-Indirect

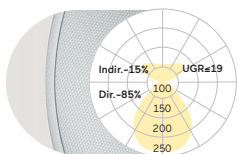

D mm	Colour Temperature	Control	Power	Lumen/Watt	Weight kg	Code Snow White	Code Urban Graphite	CHF
300	4000K	On/Off	Medium	760lm/6W	3,8	BX9AWE-840M-D300	BX9AUE-840M-D300	856,00
300	4000K	On/Off	High	1200lm/10W	3,8	BX9AWE-840H-D300	BX9AUE-840H-D300	856,00
400	4000K	On/Off	Medium	1770lm/14W	5,0	BX9AWE-840M-D400	BX9AUE-840M-D400	1066,00
400	4000K	On/Off	High	3090lm/23W	5,0	BX9AWE-840H-D400	BX9AUE-840H-D400	1066,00
500	4000K	On/Off	Medium	2840lm/21W	6,2	BX9AWE-840M-D500	BX9AUE-840M-D500	1364,00
500	4000K	On/Off	High	5230lm/38W	6,2	BX9AWE-840H-D500	BX9AUE-840H-D500	1364,00
610	4000K	On/Off	Medium	3830lm/28W	7,5	BX9AWE-840M-D610	BX9AUE-840M-D610	1871,00
610	4000K	On/Off	High	7100lm/52W	7,5	BX9AWE-840H-D610	BX9AUE-840H-D610	1871,00

Microprismatic | Direct

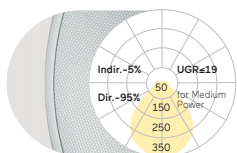

D mm	Colour Temperature	Control	Power	Lumen/Watt	Weight kg	Code Snow White	Code Urban Graphite	CHF
300	4000K	On/Off	Medium	630lm/5W	3,5	BY9AWE-840M-D300	BY9AUE-840M-D300	769,00
300	4000K	On/Off	High	1000lm/9W	3,5	BY9AWE-840H-D300	BY9AUE-840H-D300	769,00
400	4000K	On/Off	Medium	1630lm/13W	4,7	BY9AWE-840M-D400	BY9AUE-840M-D400	961,00
400	4000K	On/Off	High	2840lm/22W	4,7	BY9AWE-840H-D400	BY9AUE-840H-D400	961,00
500	4000K	On/Off	Medium	2470lm/19W	6,0	BY9AWE-840M-D500	BY9AUE-840M-D500	1206,00
500	4000K	On/Off	High	4560lm/34W	6,0	BY9AWE-840H-D500	BY9AUE-840H-D500	1206,00
610	4000K	On/Off	Medium	3340lm/25W	7,1	BY9AWE-840M-D610	BY9AUE-840M-D610	1644,00
610	4000K	On/Off	High	6200lm/46W	7,1	BY9AWE-840H-D610	BY9AUE-840H-D610	1644,00

Opal Diffuser | Direct-Indirect

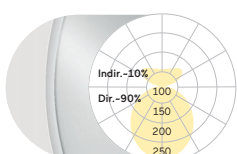

D mm	Colour Temperature	Control	Power	Lumen/Watt	Weight kg	Code Snow White	Code Urban Graphite	CHF
300	4000K	On/Off	Medium	800lm/6W	3,8	BX9OWE-840M-D300	BX9OUE-840M-D300	769,00
300	4000K	On/Off	High	1260lm/10W	3,8	BX9OWE-840H-D300	BX9OUE-840H-D300	769,00
400	4000K	On/Off	Medium	1870lm/14W	5,0	BX9OWE-840M-D400	BX9OUE-840M-D400	961,00
400	4000K	On/Off	High	3270lm/23W	5,0	BX9OWE-840H-D400	BX9OUE-840H-D400	961,00
500	4000K	On/Off	Medium	2990lm/21W	6,2	BX9OWE-840M-D500	BX9OUE-840M-D500	1224,00
500	4000K	On/Off	High	5500lm/38W	6,2	BX9OWE-840H-D500	BX9OUE-840H-D500	1224,00
610	4000K	On/Off	Medium	4040lm/28W	7,5	BX9OWE-840M-D610	BX9OUE-840M-D610	1609,00
610	4000K	On/Off	High	7470lm/52W	7,5	BX9OWE-840H-D610	BX9OUE-840H-D610	1609,00

... Basic Visio Y9/X9 | Wall

Opal Diffuser | Direct

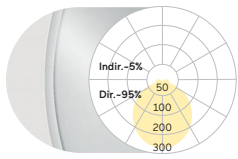

D mm	Colour Temperature	Control	Power	Lumen/Watt	Weight kg	Code Snow White	Code Urban Graphite	CHF
300	4000K	On/Off	Medium	670lm/5W	3,5	BY9OWE-840M-D300	BY9OUE-840M-D300	681,00
300	4000K	On/Off	High	1060lm/9W	3,5	BY9OWE-840H-D300	BY9OUE-840H-D300	681,00
400	4000K	On/Off	Medium	1730lm/13W	4,7	BY9OWE-840M-D400	BY9OUE-840M-D400	856,00
400	4000K	On/Off	High	3020lm/22W	4,7	BY9OWE-840H-D400	BY9OUE-840H-D400	856,00
500	4000K	On/Off	Medium	2620lm/19W	6,0	BY9OWE-840M-D500	BY9OUE-840M-D500	1066,00
500	4000K	On/Off	High	4830lm/34W	6,0	BY9OWE-840H-D500	BY9OUE-840H-D500	1066,00
610	4000K	On/Off	Medium	3550lm/25W	7,1	BY9OWE-840M-D610	BY9OUE-840M-D610	1381,00
610	4000K	On/Off	High	6570lm/46W	7,1	BY9OWE-840H-D610	BY9OUE-840H-D610	1381,00

Surcharges

Surface Finish	CHF	Control Gear	CHF	Colour Rendering	CHF	Colour Temperature	CHF	CHF	
W: Snow White	✓	E: On/Off	✓	8: CRI>80	✓	22: 2200K	+5%	40: 4000K	✓
U: Urban Graphite	✓	L: DALI	+86,00	9: CRI>90	+5%	27: 2700K	+5%	65: 6500K	+5%
R: Special RAL/NCS Colours	ⓘ	H: Touch-Dim	+86,00	F: Full Spectrum	+15%	30: 3000K	✓	TW: Tunable White 2700-6500K* [D400-D610]	+30%
		C: Casambi	+261,00			35: 3500K	+5%		
		6: DALI DT6 for TW	+172,00						
		8: DALI DT8 for TW	+172,00						

*Only in combination with DALI. Please add to dimming price.

✓ standard / no extra charge ⓘ on request ✗ not available

Liquid Line W5 | Compact Wall

catalogue page **140**

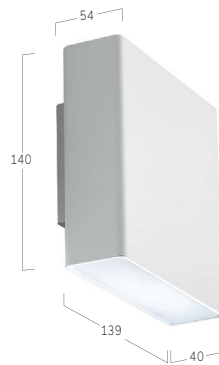

Opal Diffuser | Direct-Indirect

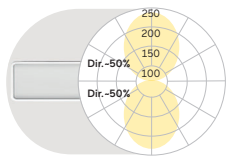

Control Gear	Colour Temperature	Power	Lumen/Watt	Weight kg	Code Snow White	Code Radiant Silver	CHF
On/Off	4000K	High	1440lm/16W	1,0	QW5OWE-840H-L139	QW5OSE-840H-L139	541,00

Surcharges

Surface Finish	CHF	Control Gear	CHF	Colour Rendering	CHF	Colour Temperature	CHF
W: Snow White	✓	E: On/Off	✓	8: CRI>80	✓	22: 2200K	+5%
V: Ivory White	✓	L: DALI	+86,00	9: CRI>90	+5%	27: 2700K	+5%
S: Radiant Silver	✓	H: Touch-Dim	+86,00	F: Full Spectrum	+15%	30: 3000K	✓
U: Urban Graphite	✓					35: 3500K	+5%
						40: 4000K	✓
						65: 6500K	+5%

✓ standard / no extra charge ⓘ on request ✗ not available

Liquid Line WX | System 40mm Wall

catalogue page **142**

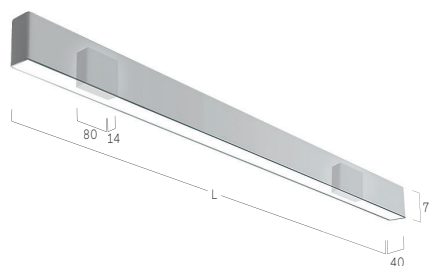

Opal Diffuser | Direct-Indirect

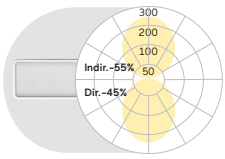

L mm	Colour Temperature	Control	Power	Lumen/Watt	Weight kg	Code Snow White	Code Radiant Silver	CHF
600	4000K	On/Off	Medium	1840lm/17W	2,0	QWXOWE-840M-L600	QWXOSE-840M-L600	734,00
600	4000K	On/Off	High	2420lm/23W	2,0	QWXOWE-840H-L600	QWXOSE-840H-L600	734,00
890	4000K	On/Off	Medium	2850lm/26W	2,8	QWXOWE-840M-L890	QWXOSE-840M-L890	769,00
890	4000K	On/Off	High	3740lm/33W	2,8	QWXOWE-840H-L890	QWXOSE-840H-L890	769,00
1182	4000K	On/Off	Medium	3860lm/33W	3,5	QWXOWE-840M-L1182	QWXOSE-840M-L1182	804,00
1182	4000K	On/Off	High	5080lm/44W	3,5	QWXOWE-840H-L1182	QWXOSE-840H-L1182	804,00
1475	4000K	On/Off	Medium	4870lm/41W	4,1	QWXOWE-840M-L1475	QWXOSE-840M-L1475	909,00
1475	4000K	On/Off	High	6410lm/54W	4,1	QWXOWE-840H-L1475	QWXOSE-840H-L1475	909,00
1765	4000K	On/Off	Medium	5890lm/48W	4,7	QWXOWE-840M-L1765	QWXOSE-840M-L1765	1092,00
1765	4000K	On/Off	High	7740lm/64W	4,7	QWXOWE-840H-L1765	QWXOSE-840H-L1765	1092,00
2055	4000K	On/Off	Medium	6910lm/59W	5,9	QWXOWE-840M-L2055	QWXOSE-840M-L2055	1302,00
2055	4000K	On/Off	High	9070lm/78W	5,9	QWXOWE-840H-L2055	QWXOSE-840H-L2055	1302,00

Surcharges

Surface Finish	CHF	Control Gear	CHF	Colour Rendering	CHF	Colour Temperature	CHF	Additional Options	CHF		
W: Snow White	✓	E: On/Off	✓	8: CRI>80	✓	22: 2200K	+5%	Emergency Module [DALI, Autotest, incl. 3H Battery] +366,00 [L1182-L2055]			
V: Ivory White	✓	L: DALI	+86,00	9: CRI>90	+5%	27: 2700K	+5%				
S: Radiant Silver	✓	H: Touch-Dim	+86,00	F: Full Spectrum	+15%	30: 3000K	✓				
U: Urban Graphite	✓	C: Casambi*	+261,00			35: 3500K	+5%				
B: Jet Black	✓	6: DALI DT6 for TW	+172,00			40: 4000K	✓				
H: Anodic Champagne	+10%	8: DALI DT8 for TW	+172,00			65: 6500K	+5%				
K: Satin Copper	+15%					TW: Tunable White 2700-6500K*	+30%				
R: Special RAL/NCS Colours	🔴	*Only in combination with DALI. Please add to dimming price.				*Only in combination with DT6, DT8 or Casambi control. Please add additional control price.					
✓ standard / no extra charge 🔴 on request 🚫 not available											

Caleo Neo Y6/X6 | Wall

catalogue page 144

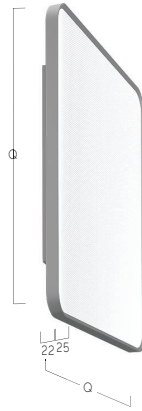

Microprismatic | Direct-Indirect

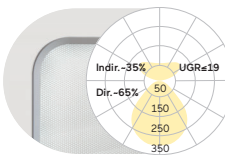

Q mm	Colour Temperature	Control	Power	Lumen/Watt	Weight kg	Code Snow White	Code Radiant Silver	CHF
300	4000K	On/Off	Medium	1990lm/17W	2,2	AX6AWE-840M-Q300-W	AX6ASE-840M-Q300-S	856,00
300	4000K	On/Off	High	2700lm/22W	2,2	AX6AWE-840H-Q300-W	AX6ASE-840H-Q300-S	856,00
400	4000K	On/Off	Medium	2930lm/23W	3,9	AX6AWE-840M-Q400-W	AX6ASE-840M-Q400-S	994,00
400	4000K	On/Off	High	3890lm/31W	3,9	AX6AWE-840H-Q400-W	AX6ASE-840H-Q400-S	994,00
500	4000K	On/Off	Medium	5140lm/39W	6,1	AX6AWE-840M-Q500-W	AX6ASE-840M-Q500-S	1122,00
500	4000K	On/Off	High	6720lm/52W	6,1	AX6AWE-840H-Q500-W	AX6ASE-840H-Q500-S	1122,00
600	4000K	On/Off	Medium	6790lm/54W	7,1	AX6AWE-840M-Q600-W	AX6ASE-840M-Q600-S	1278,00
600	4000K	On/Off	High	9230lm/73W	7,1	AX6AWE-840H-Q600-W	AX6ASE-840H-Q600-S	1278,00
800	4000K	On/Off	Medium	10780lm/86W	8,5	AX6AWE-840M-Q800-W	AX6ASE-840M-Q800-S	2246,00
800	4000K	On/Off	High	14900lm/121W	8,5	AX6AWE-840H-Q800-W	AX6ASE-840H-Q800-S	2246,00

Microprismatic | Direct

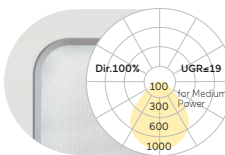

Q mm	Colour Temperature	Control	Power	Lumen/Watt	Weight kg	Code Snow White	Code Radiant Silver	CHF
300	4000K	On/Off	Medium	1230lm/11W	2,1	AY6AWE-840M-Q300-W	AY6ASE-840M-Q300-S	739,00
300	4000K	On/Off	High	1670lm/15W	2,1	AY6AWE-840H-Q300-W	AY6ASE-840H-Q300-S	739,00
400	4000K	On/Off	Medium	2060lm/18W	3,8	AY6AWE-840M-Q400-W	AY6ASE-840M-Q400-S	839,00
400	4000K	On/Off	High	2720lm/23W	3,8	AY6AWE-840H-Q400-W	AY6ASE-840H-Q400-S	839,00
500	4000K	On/Off	Medium	3180lm/26W	5,9	AY6AWE-840M-Q500-W	AY6ASE-840M-Q500-S	1003,00
500	4000K	On/Off	High	4180lm/35W	5,9	AY6AWE-840H-Q500-W	AY6ASE-840H-Q500-S	1003,00
600	4000K	On/Off	Medium	4800lm/39W	7,0	AY6AWE-840M-Q600-W	AY6ASE-840M-Q600-S	1122,00
600	4000K	On/Off	High	6480lm/53W	7,0	AY6AWE-840H-Q600-W	AY6ASE-840H-Q600-S	1122,00
800	4000K	On/Off	Medium	7720lm/65W	8,5	AY6AWE-840M-Q800-W	AY6ASE-840M-Q800-S	2058,00
800	4000K	On/Off	High	10450lm/90W	8,5	AY6AWE-840H-Q800-W	AY6ASE-840H-Q800-S	2058,00

... Caleo Neo Y6/X6 | Wall

Opal Diffuser | Direct-Indirect

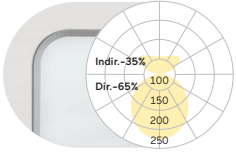

Q mm	Colour Temperature	Control	Power	Lumen/Watt	Weight kg	Code Snow White	Code Radiant Silver	CHF
300	4000K	On/Off	Medium	2000lm/17W	5,0	AX6OWE-840M-Q300-W	AX6OSE-840M-Q300-S	839,00
300	4000K	On/Off	High	2720lm/22W	5,0	AX6OWE-840H-Q300-W	AX6OSE-840H-Q300-S	839,00
400	4000K	On/Off	Medium	2950lm/23W	9,0	AX6OWE-840M-Q400-W	AX6OSE-840M-Q400-S	954,00
400	4000K	On/Off	High	3910lm/31W	9,0	AX6OWE-840H-Q400-W	AX6OSE-840H-Q400-S	954,00
500	4000K	On/Off	Medium	5170lm/39W	13,0	AX6OWE-840M-Q500-W	AX6OSE-840M-Q500-S	1080,00
500	4000K	On/Off	High	6760lm/52W	13,0	AX6OWE-840H-Q500-W	AX6OSE-840H-Q500-S	1080,00
600	4000K	On/Off	Medium	6830lm/54W	16,0	AX6OWE-840M-Q600-W	AX6OSE-840M-Q600-S	1220,00
600	4000K	On/Off	High	9290lm/73W	16,0	AX6OWE-840H-Q600-W	AX6OSE-840H-Q600-S	1220,00
800	4000K	On/Off	Medium	10840lm/86W	19,0	AX6OWE-840M-Q800-W	AX6OSE-840M-Q800-S	2190,00
800	4000K	On/Off	High	14990lm/121W	19,0	AX6OWE-840H-Q800-W	AX6OSE-840H-Q800-S	2190,00

Opal Diffuser | Direct

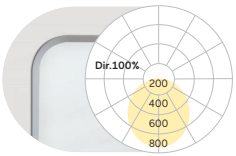

Q mm	Colour Temperature	Control	Power	Lumen/Watt	Weight kg	Code Snow White	Code Radiant Silver	CHF
300	4000K	On/Off	Medium	1240lm/11W	2,1	AY6OWE-840M-Q300-W	AY6OSE-840M-Q300-S	721,00
300	4000K	On/Off	High	1690lm/15W	2,1	AY6OWE-840H-Q300-W	AY6OSE-840H-Q300-S	721,00
400	4000K	On/Off	Medium	2080lm/18W	3,8	AY6OWE-840M-Q400-W	AY6OSE-840M-Q400-S	798,00
400	4000K	On/Off	High	2740lm/23W	3,8	AY6OWE-840H-Q400-W	AY6OSE-840H-Q400-S	798,00
500	4000K	On/Off	Medium	3210lm/26W	5,9	AY6OWE-840M-Q500-W	AY6OSE-840M-Q500-S	965,00
500	4000K	On/Off	High	4220lm/35W	5,9	AY6OWE-840H-Q500-W	AY6OSE-840H-Q500-S	965,00
600	4000K	On/Off	Medium	4840lm/39W	7,0	AY6OWE-840M-Q600-W	AY6OSE-840M-Q600-S	1063,00
600	4000K	On/Off	High	6540lm/53W	7,0	AY6OWE-840H-Q600-W	AY6OSE-840H-Q600-S	1063,00
800	4000K	On/Off	Medium	7780lm/65W	8,5	AY6OWE-840M-Q800-W	AY6OSE-840M-Q800-S	2002,00
800	4000K	On/Off	High	10540lm/90W	8,5	AY6OWE-840H-Q800-W	AY6OSE-840H-Q800-S	2002,00

Surcharges

Surface / Reflector Finish

Uni-Colours

Code	Finish	CHF
W...W:	Snow White / Snow White	✓
V...V:	Ivory White / Ivory White	✓
S...S:	Radiant Silver / Radiant Silver	✓
U...U:	Urban Graphite / Urban Graphite	✓
B...B:	Jet Black / Jet Black	✓
H...H:	Anodic Champ. / Anodic Champ.	+5%
K...K:	Satin Copper / Satin Copper	+15%

Surface / Reflector Finish

Dual Colours

Code	Finish	CHF
W...G:	Snow White / Satin Gold	+15%
W...K:	Snow White / Satin Copper	+15%
W...B:	Snow White / Jet Black	+15%
H...B:	Anodic Champagne / Jet Black	+15%
B...G:	Jet Black / Satin Gold	+15%
B...W:	Jet Black / Snow White	+15%

Control Gear

Code	Control	CHF
E:	On/Off	✓
L:	DALI	+86,00
H:	Touch-Dim	+86,00
6:	DALI DT6 for TW	+172,00
8:	DALI DT8 for TW	+172,00

Colour Rendering

Code	Rendering	CHF
8:	CRI>80	✓
9:	CRI>90	+5%
F:	Full Spectrum	+15%

Colour Temperature

Code	Temperature	CHF
22:	2200K	+5%
27:	2700K	+5%
30:	3000K	✓
35:	3500K	+5%
40:	4000K	✓
65:	6500K	+5%
TW:	Tunable White 2700-6500K*	+30%

*Only in combination with DT6 or DT8 control. Please add additional control price.

✓ standard / no extra charge ⚡ on request ✗ not available

Cubic Evolution W4 | Wall

catalogue page 148

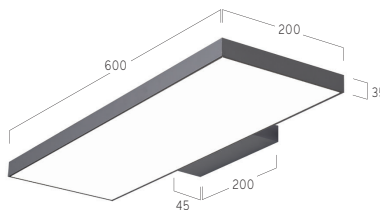
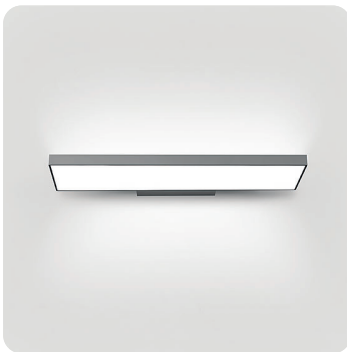

Microprismatic | Direct-Indirect

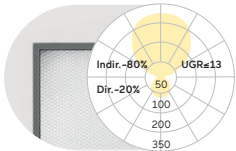

L mm	Colour Temperature	Control	Power	Lumen/Watt	Weight kg	Code Snow White	Code Silver Anodised	CHF
600	4000K	On/Off	Medium	6550lm/47W	3,3	CW4AWE-840M-L600	CW4AEE-840M-L600	779,00

Opal Diffuser | Direct-Indirect

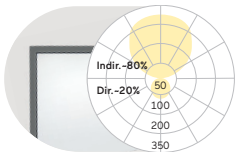

L mm	Colour Temperature	Control	Power	Lumen/Watt	Weight kg	Code Snow White	Code Silver Anodised	CHF
600	4000K	On/Off	Medium	6510lm/47W	3,3	CW4OWE-840M-L600	CW4OEE-840M-L600	741,00

Surcharges

Surface / Reflector Finish	CHF	Control Gear	CHF	Colour Rendering	CHF	Colour Temperature	CHF
W: Snow White	✓	E: On/Off	✓	B: CRI>80	✓	22: 2200K	+5%
E: Silver Anodised	✓	L: DALI	+86,00	9: CRI>90	+5%	27: 2700K	+5%
U: Urban Graphite	✓	H: Touch-Dim	+86,00	F: Full Spectrum	+15%	30: 3000K	✓
B: Jet Black	✓					35: 3500K	+5%
H: Anodic Champagne	+10%					40: 4000K	✓
R: Special RAL/NCS Colours	ⓘ					65: 6500K	+5%

✓ standard / no extra charge ⓘ on request ✗ not available

Cubic Evolution Y6/X6 | Wall

catalogue page **150**

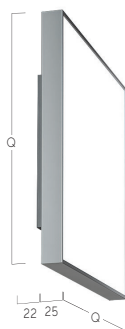
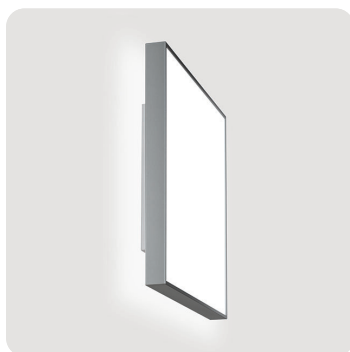

Microprismatic | Direct-Indirect

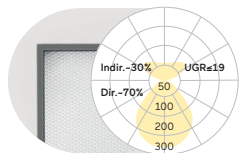

Q mm	Colour Temperature	Control	Power	Lumen/Watt	Weight kg	Code Snow White	Code Silver Anodised	CHF
300	4000K	On/Off	Medium	1970lm/16W	2,7	CX6AWE-840M-Q300	CX6AEE-840M-Q300	807,00
300	4000K	On/Off	High	2850lm/24W	2,7	CX6AWE-840H-Q300	CX6AEE-840H-Q300	807,00
400	4000K	On/Off	Medium	2920lm/23W	4,4	CX6AWE-840M-Q400	CX6AEE-840M-Q400	937,00
400	4000K	On/Off	High	4170lm/32W	4,4	CX6AWE-840H-Q400	CX6AEE-840H-Q400	937,00
500	4000K	On/Off	Medium	4580lm/33W	6,7	CX6AWE-840M-Q500	CX6AEE-840M-Q500	1057,00
500	4000K	On/Off	High	5900lm/44W	6,7	CX6AWE-840H-Q500	CX6AEE-840H-Q500	1057,00
600	4000K	On/Off	Medium	7240lm/55W	7,6	CX6AWE-840M-Q600	CX6AEE-840M-Q600	1204,00
600	4000K	On/Off	High	9850lm/76W	7,6	CX6AWE-840H-Q600	CX6AEE-840H-Q600	1204,00
800	4000K	On/Off	Medium	10590lm/76W	9,0	CX6AWE-840M-Q800	CX6AEE-840M-Q800	2246,00
800	4000K	On/Off	High	14950lm/109W	9,0	CX6AWE-840H-Q800	CX6AEE-840H-Q800	2246,00

Microprismatic | Direct

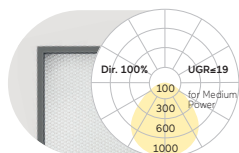

Q mm	Colour Temperature	Control	Power	Lumen/Watt	Weight kg	Code Snow White	Code Silver Anodised	CHF
300	4000K	On/Off	Medium	1210lm/11W	2,6	CY6AWE-840M-Q300	CY6AEE-840M-Q300	697,00
300	4000K	On/Off	High	1740lm/16W	2,6	CY6AWE-840H-Q300	CY6AEE-840H-Q300	697,00
400	4000K	On/Off	Medium	1960lm/16W	4,3	CY6AWE-840M-Q400	CY6AEE-840M-Q400	790,00
400	4000K	On/Off	High	2860lm/24W	4,3	CY6AWE-840H-Q400	CY6AEE-840H-Q400	790,00
500	4000K	On/Off	Medium	3330lm/26W	6,5	CY6AWE-840M-Q500	CY6AEE-840M-Q500	945,00
500	4000K	On/Off	High	4290lm/34W	6,5	CY6AWE-840H-Q500	CY6AEE-840H-Q500	945,00
600	4000K	On/Off	Medium	5250lm/40W	7,5	CY6AWE-840M-Q600	CY6AEE-840M-Q600	1057,00
600	4000K	On/Off	High	7100lm/55W	7,5	CY6AWE-840H-Q600	CY6AEE-840H-Q600	1057,00
800	4000K	On/Off	Medium	7590lm/55W	9,0	CY6AWE-840M-Q800	CY6AEE-840M-Q800	2058,00
800	4000K	On/Off	High	10630lm/78W	9,0	CY6AWE-840H-Q800	CY6AEE-840H-Q800	2058,00

Opal Diffuser | Direct-Indirect

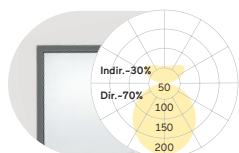

Q mm	Colour Temperature	Control	Power	Lumen/Watt	Weight kg	Code Snow White	Code Silver Anodised	CHF
300	4000K	On/Off	Medium	1930lm/16W	2,7	CX6OWE-840M-Q300	CX6OEE-840M-Q300	790,00
300	4000K	On/Off	High	2760lm/24W	2,7	CX6OWE-840H-Q300	CX6OEE-840H-Q300	790,00
400	4000K	On/Off	Medium	2870lm/23W	4,4	CX6OWE-840M-Q400	CX6OEE-840M-Q400	900,00
400	4000K	On/Off	High	4120lm/32W	4,4	CX6OWE-840H-Q400	CX6OEE-840H-Q400	900,00
500	4000K	On/Off	Medium	4550lm/33W	6,7	CX6OWE-840M-Q500	CX6OEE-840M-Q500	1019,00
500	4000K	On/Off	High	5880lm/44W	6,7	CX6OWE-840H-Q500	CX6OEE-840H-Q500	1019,00
600	4000K	On/Off	Medium	7170lm/55W	7,6	CX6OWE-840M-Q600	CX6OEE-840M-Q600	1150,00
600	4000K	On/Off	High	9750lm/76W	7,6	CX6OWE-840H-Q600	CX6OEE-840H-Q600	1150,00
800	4000K	On/Off	Medium	10370lm/76W	9,0	CX6OWE-840M-Q800	CX6OEE-840M-Q800	2190,00
800	4000K	On/Off	High	14440lm/109W	9,0	CX6OWE-840H-Q800	CX6OEE-840H-Q800	2190,00

Opal Diffuser | Direct

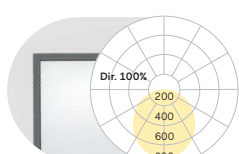

Q mm	Colour Temperature	Control	Power	Lumen/Watt	Weight kg	Code Snow White	Code Silver Anodised	CHF
300	4000K	On/Off	Medium	1170lm/11W	2,6	CY6OWE-840M-Q300	CY6OEE-840M-Q300	679,00
300	4000K	On/Off	High	1650lm/16W	2,6	CY6OWE-840H-Q300	CY6OEE-840H-Q300	679,00
400	4000K	On/Off	Medium	1910lm/16W	4,3	CY6OWE-840M-Q400	CY6OEE-840M-Q400	753,00
400	4000K	On/Off	High	2810lm/24W	4,3	CY6OWE-840H-Q400	CY6OEE-840H-Q400	753,00
500	4000K	On/Off	Medium	3300lm/26W	6,5	CY6OWE-840M-Q500	CY6OEE-840M-Q500	909,00
500	4000K	On/Off	High	4270lm/34W	6,5	CY6OWE-840H-Q500	CY6OEE-840H-Q500	909,00
600	4000K	On/Off	Medium	5180lm/40W	7,5	CY6OWE-840M-Q600	CY6OEE-840M-Q600	1001,00
600	4000K	On/Off	High	7000lm/55W	7,5	CY6OWE-840H-Q600	CY6OEE-840H-Q600	1001,00
800	4000K	On/Off	Medium	7370lm/55W	9,0	CY6OWE-840M-Q800	CY6OEE-840M-Q800	2002,00
800	4000K	On/Off	High	10120lm/78W	9,0	CY6OWE-840H-Q800	CY6OEE-840H-Q800	2002,00

Surcharges

Surface / Reflector Finish	CHF	Control Gear	CHF	Colour Rendering	CHF	Colour Temperature	CHF	Additional Options	CHF
W: Snow White	✓	E: On/Off	✓	8: CRI>80	✓	22: 2200K	+5%	Emergency Module [DALI, Autotest, incl. 3H Battery]	+366,00 [Q400-Q800]
E: Silver Anodised	✓	L: DALI	+86,00	9: CRI>90	+5%	27: 2700K	+5%		
U: Urban Graphite	✓	H: Touch-Dim	+86,00	F: Full Spectrum	+15%	30: 3000K	✓		
B: Jet Black	✓	C: Casambi*	+261,00			35: 3500K	+5%		
H: Anodic Champagne	+10%	6: DALI DT6 for TW	+172,00			40: 4000K	✓		
R: Special RAL/NCS Colours	ⓘ	8: DALI DT8 for TW	+172,00			65: 6500K	+5%		
		Only in combination with DALI. Please add to dimming price.				TW: Tunable White 2700-6500K	+30%		
						*Only in combination with DT6, DT8 or Casambi control. Please add additional control price.			
✓ standard / no extra charge ⓘ on request ✗ not available									

Cubic Déco A3 | Wall

catalogue page 152



Microprismatic | Direct

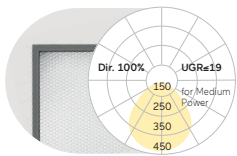

Q mm	Colour Temperature	Control	Power	Lumen/Watt	Weight kg	Code Snow White	Code Radiant Silver	CHF
330	4000K	On/Off	Medium	1360lm/12W	4,7	CA3AWE-840M-Q330-W	CA3ASE-840M-Q330-A	622,00
330	4000K	On/Off	High	2010lm/18W	4,7	CA3AWE-840H-Q330-W	CA3ASE-840H-Q330-A	622,00
430	4000K	On/Off	Medium	2370lm/19W	7,2	CA3AWE-840M-Q430-W	CA3ASE-840M-Q430-A	730,00
430	4000K	On/Off	High	3450lm/27W	7,2	CA3AWE-840H-Q430-W	CA3ASE-840H-Q430-A	730,00
530	4000K	On/Off	Medium	3630lm/27W	10,0	CA3AWE-840M-Q530-W	CA3ASE-840M-Q530-A	895,00
530	4000K	On/Off	High	6790lm/50W	10,0	CA3AWE-840H-Q530-W	CA3ASE-840H-Q530-A	895,00
630	4000K	On/Off	Medium	5200lm/40W	14,4	CA3AWE-840M-Q630-W	CA3ASE-840M-Q630-A	1040,00
630	4000K	On/Off	High	8500lm/65W	14,4	CA3AWE-840H-Q630-W	CA3ASE-840H-Q630-A	1040,00
900	4000K	On/Off	Medium	7910lm/67W	16,9	CA3AWE-840M-Q900-W	CA3ASE-840M-Q900-A	2198,00
900	4000K	On/Off	High	13240lm/129W	16,9	CA3AWE-840H-Q900-W	CA3ASE-840H-Q900-A	2198,00
1200	4000K	On/Off	Medium	14100lm/122W	22,1	CA3AWE-840M-Q1200-W	CA3ASE-840M-Q1200-A	3341,00
1200	4000K	On/Off	High	23550lm/228W	22,1	CA3AWE-840H-Q1200-W	CA3ASE-840H-Q1200-A	3341,00

Opal Diffuser | Direct

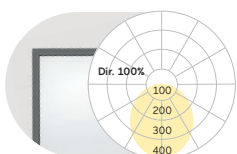

Q mm	Colour Temperature	Control	Power	Lumen/Watt	Weight kg	Code Snow White	Code Radiant Silver	CHF
330	4000K	On/Off	Medium	1400lm/12W	4,7	CA3OWE-840M-Q330-W	CA3OSE-840M-Q330-A	529,00
330	4000K	On/Off	High	2070lm/18W	4,7	CA3OWE-840H-Q330-W	CA3OSE-840H-Q330-A	529,00
430	4000K	On/Off	Medium	2440lm/19W	7,2	CA3OWE-840M-Q430-W	CA3OSE-840M-Q430-A	639,00
430	4000K	On/Off	High	3550lm/27W	7,2	CA3OWE-840H-Q430-W	CA3OSE-840H-Q430-A	639,00
530	4000K	On/Off	Medium	3740lm/27W	10,0	CA3OWE-840M-Q530-W	CA3OSE-840M-Q530-A	840,00
530	4000K	On/Off	High	6990lm/50W	10,0	CA3OWE-840H-Q530-W	CA3OSE-840H-Q530-A	840,00
630	4000K	On/Off	Medium	5360lm/40W	14,4	CA3OWE-840M-Q630-W	CA3OSE-840M-Q630-A	984,00
630	4000K	On/Off	High	8760lm/65W	14,4	CA3OWE-840H-Q630-W	CA3OSE-840H-Q630-A	984,00
900	4000K	On/Off	Medium	8150lm/67W	16,9	CA3OWE-840M-Q900-W	CA3OSE-840M-Q900-A	2106,00
900	4000K	On/Off	High	13640lm/129W	16,9	CA3OWE-840H-Q900-W	CA3OSE-840H-Q900-A	2106,00
1200	4000K	On/Off	Medium	14520lm/122W	22,1	CA3OWE-840M-Q1200-W	CA3OSE-840M-Q1200-A	3210,00
1200	4000K	On/Off	High	24260lm/228W	22,1	CA3OWE-840H-Q1200-W	CA3OSE-840H-Q1200-A	3210,00

Surcharges

Surface / Reflector Finish	CHF	Surface / Reflector Finish	CHF	Control Gear	CHF	Colour Temperature	CHF
Uni-Colours		Dual Colours			Q330-Q630 Q900-Q1200		
W...W: Snow White / Snow White	✓	W...G: Snow White / Satin Gold	+15%	E: On/Off	✓	22: 2200K	+5%
V...V: Ivory White / Ivory White	✓	W...K: Snow White / Satin Copper	+15%	L: DALI	+86,00 +172,00	27: 2700K	+5%
A...A: Satin Silver / Satin Silver	✓	W...B: Snow White / Jet Black	+15%	C: Casambi*	+261,00 +261,00	30: 3000K	✓
U...U: Urban Graphite / Urban Graphite	✓	H...B: Anodic Champagne / Jet Black	+15%	H: Touch-Dim	+86,00 +172,00	35: 3500K	+5%
B...B: Jet Black / Jet Black	✓	B...G: Jet Black / Satin Gold	+15%	6: DALI DT6 for TW	+172,00 +343,00	40: 4000K	✓
H...H: Anodic Champ. / Anodic Champ.	+5%	B...W: Jet Black / Snow White	+15%	8: DALI DT8 for TW	+172,00 +343,00	65: 6500K	+5%
K...K: Satin Copper / Satin Copper	+15%			*Only in combination with DALI. Please add to dimming price.			TW: Tunable White 2700-6500K* +30%
				Colour Rendering	CHF	*Only in combination with DT6, DT8 or Casambi control. Please add additional control price.	
				8: CRI>80	✓		
				9: CRI>90	+5%		
				F: Full Spectrum	+15%		
✓ standard / no extra charge ⓘ on request ✗ not available							

Cubic Ambient A7 | Wall

catalogue page 154

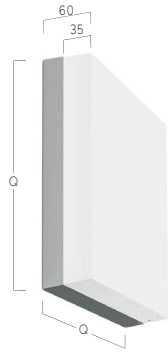

Ambient Diffuser | Direct

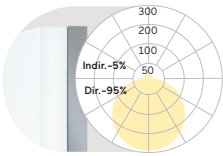

Q mm	Colour Temperature	Control	Power	Lumen/Watt	Weight kg	Code Snow White	Code Radiant Silver	CHF
300	4000K	On/Off	Medium	1480lm/12W	3,0	CA7FWE-840M-Q300	CA7FSE-840M-Q300	594,00
300	4000K	On/Off	High	2150lm/15W	3,0	CA7FWE-840H-Q300	CA7FSE-840H-Q300	594,00
400	4000K	On/Off	Medium	2950lm/21W	5,0	CA7FWE-840M-Q400	CA7FSE-840M-Q400	667,00
400	4000K	On/Off	High	3880lm/27W	5,0	CA7FWE-840H-Q400	CA7FSE-840H-Q400	667,00
500	4000K	On/Off	Medium	4410lm/30W	7,0	CA7FWE-840M-Q500	CA7FSE-840M-Q500	814,00
500	4000K	On/Off	High	6520lm/43W	7,0	CA7FWE-840H-Q500	CA7FSE-840H-Q500	814,00
600	4000K	On/Off	Medium	5650lm/38W	9,5	CA7FWE-840M-Q600	CA7FSE-840M-Q600	924,00
600	4000K	On/Off	High	8540lm/58W	9,5	CA7FWE-840H-Q600	CA7FSE-840H-Q600	924,00

Surcharges

Surface Finish

Surface Finish	CHF
W: Snow White	✓
S: Radiant Silver	✓
U: Urban Graphite	✓
B: Jet Black	✓
H: Anodic Champagne	+10%
R: Special RAL/NCS Colours	🕒

Control Gear

Control Gear	CHF
E: On/Off	✓
L: DALI	+86,00
H: Touch-Dim	+86,00
C: Casambi*	+261,00

*Only in combination with DALI. Please add to dimming price.

Colour Rendering

Colour Rendering	CHF
8: CRI>80	✓
9: CRI>90	+5%
F: Full Spectrum	+15%

Colour Temperature

Colour Temperature	CHF
22: 2200K	+5%
27: 2700K	+5%
30: 3000K	✓
35: 3500K	+5%
40: 4000K	✓
65: 6500K	+5%

Additional Options

Emergency Module [DALI, Autotest, incl. 3H Battery] +366,00 [Q400-Q600]

✓ standard / no extra charge 🕒 on request ✗ not available

Matric Ambient AX | System 40 mm Wall

catalogue page 158



Ambient | Direct

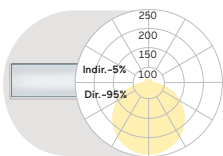

L mm	Colour Temperature	Control	Power	Lumen/Watt	Weight kg	Code Snow White	Code Silver Anodised	CHF
600	4000K	On/Off	Medium	1080lm/9W	1,2	LAXFWE-840M-L600	LAXFEE-840M-L600	459,00
600	4000K	On/Off	High	1460lm/12W	1,2	LAXFWE-840H-L600	LAXFEE-840H-L600	459,00
890	4000K	On/Off	Medium	1620lm/12W	1,6	LAXFWE-840M-L890	LAXFEE-840M-L890	482,00
890	4000K	On/Off	High	2190lm/16W	1,6	LAXFWE-840H-L890	LAXFEE-840H-L890	482,00
1182	4000K	On/Off	Medium	2150lm/16W	2,0	LAXFWE-840M-L1182	LAXFEE-840M-L1182	518,00
1182	4000K	On/Off	High	2910lm/21W	2,0	LAXFWE-840H-L1182	LAXFEE-840H-L1182	518,00
1475	4000K	On/Off	Medium	2690lm/19W	2,4	LAXFWE-840M-L1475	LAXFEE-840M-L1475	594,00
1475	4000K	On/Off	High	3640lm/26W	2,4	LAXFWE-840H-L1475	LAXFEE-840H-L1475	594,00
1765	4000K	On/Off	Medium	3230lm/22W	2,8	LAXFWE-840M-L1765	LAXFEE-840M-L1765	711,00
1765	4000K	On/Off	High	4370lm/30W	2,8	LAXFWE-840H-L1765	LAXFEE-840H-L1765	711,00
2055	4000K	On/Off	Medium	3770lm/28W	3,5	LAXFWE-840M-L2055	LAXFEE-840M-L2055	903,00
2055	4000K	On/Off	High	5100lm/37W	3,5	LAXFWE-840H-L2055	LAXFEE-840H-L2055	903,00
per meter	4000K	On/Off	Medium	1830lm/12,6W	1,7	LAXFWE-840M-L****	LAXFEE-840M-L****	447,00
per meter	4000K	On/Off	High	2480lm/17,2W	1,7	LAXFWE-840H-L****	LAXFEE-840H-L****	447,00
per meter	4000K	DALI	Medium	1830lm/12,6W	1,7	LAXFWL-840M-L****	LAXFEL-840M-L****	499,00
per meter	4000K	DALI	High	2480lm/17,2W	1,7	LAXFWL-840H-L****	LAXFEL-840H-L****	499,00

**** - your length in mm

Surcharges										
Surface Finish	CHF	Control Gear	CHF	CHF	Colour Rendering	CHF	Colour Temperature	CHF	Additional Options	CHF
W: Snow White	✓	E: On/Off	L600-L1765	L2055	8: CRI>80	✓	22: 2200K	+5%	Emergency Module [DALI, Autotest, incl. 3H Battery] [L1182-L2055]	+366,00
V: Ivory White	✓	L: DALI	+86,00	+172,00	9: CRI>90	+5%	27: 2700K	+5%		
E: Silver Anodised	✓	C: Casambi*	+261,00	+261,00	F: Full Spectrum	+15%	30: 3000K	✓		
U: Urban Graphite	✓	H: Touch-Dim	+86,00	+172,00			35: 3500K	+5%		
B: Jet Black	✓	6: DALI DT6 for TW	+172,00	+343,00			40: 4000K	✓		
H: Anodic Champagne	+10%	8: DALI DT8 for TW	+172,00	+343,00			65: 6500K	+5%		
K: Satin Copper	+15%						TW: Tunable White 2700-6500K*	+30%		
R: Special RAL/NCS Colours	🔔	*Only in combination with DALI. Please add to dimming price.			*Only in combination with DT6, DT8 or Casambi control. Please add additional control price.					

✓ standard / no extra charge
🔔 on request
✗ not available

Matric WX | System 40 mm Wall

catalogue page 160

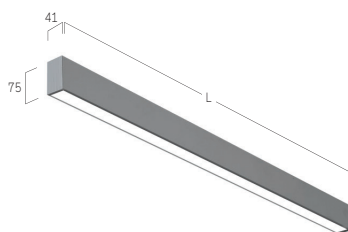

Microprismatic | Direct-Indirect

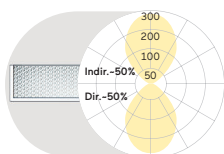

L mm	Colour Temperature	Control	Power	Lumen/Watt	Weight kg	Code Snow White	Code Silver Anodised	CHF
600	4000K	On/Off	Low	1730lm/17W	2,2	LWXAW E-840E-L600	LWXAE E-840E-L600	709,00
600	4000K	On/Off	High	2650lm/26W	2,2	LWXAW E-840H-L600	LWXAE E-840H-L600	709,00
895	4000K	On/Off	Low	2600lm/24W	2,9	LWXAW E-840E-L895	LWXAE E-840E-L895	734,00
895	4000K	On/Off	High	3970lm/38W	2,9	LWXAW E-840H-L895	LWXAE E-840H-L895	734,00
1185	4000K	On/Off	Low	3470lm/32W	3,7	LWXAW E-840E-L1185	LWXAE E-840E-L1185	779,00
1185	4000K	On/Off	High	5300lm/51W	3,7	LWXAW E-840H-L1185	LWXAE E-840H-L1185	779,00
1478	4000K	On/Off	Low	4340lm/40W	4,2	LWXAW E-840E-L1478	LWXAE E-840E-L1478	891,00
1478	4000K	On/Off	High	6620lm/62W	4,2	LWXAW E-840H-L1478	LWXAE E-840H-L1478	891,00
1770	4000K	On/Off	Low	5200lm/48W	4,8	LWXAW E-840E-L1770	LWXAE E-840E-L1770	1066,00
1770	4000K	On/Off	High	7940lm/73W	4,8	LWXAW E-840H-L1770	LWXAE E-840H-L1770	1066,00
2060	4000K	On/Off	Low	6070lm/57W	6,0	LWXAW E-840E-L2060	LWXAE E-840E-L2060	1294,00
2060	4000K	On/Off	High	9270lm/90W	6,0	LWXAW E-840H-L2060	LWXAE E-840H-L2060	1294,00
per meter	4000K	On/Off	Low	2950lm/26,9W	3,3	LWXAW E-840E-L****	LWXAE E-840E-L****	587,00
per meter	4000K	On/Off	High	4500lm/41,6W	3,3	LWXAW E-840H-L****	LWXAE E-840H-L****	587,00
per meter	4000K	DALI	Low	2950lm/26,9W	3,3	LWXAW L-840E-L****	LWXAE L-840E-L****	657,00
per meter	4000K	DALI	High	4500lm/41,6W	3,3	LWXAW L-840H-L****	LWXAE L-840H-L****	657,00

Opal Diffuser | Direct-Indirect

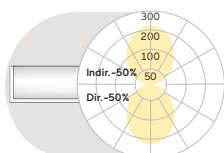

L mm	Colour Temperature	Control	Power	Lumen/Watt	Weight kg	Code Snow White	Code Silver Anodised	CHF
600	4000K	On/Off	Medium	2240lm/21W	2,2	LWXOW E-840M-L600	LWXOE E-840M-L600	692,00
600	4000K	On/Off	High	2820lm/26W	2,2	LWXOW E-840H-L600	LWXOE E-840H-L600	692,00
895	4000K	On/Off	Medium	3360lm/30W	2,9	LWXOW E-840M-L895	LWXOE E-840M-L895	716,00
895	4000K	On/Off	High	4230lm/38W	2,9	LWXOW E-840H-L895	LWXOE E-840H-L895	716,00
1185	4000K	On/Off	Medium	4470lm/40W	3,7	LWXOW E-840M-L1185	LWXOE E-840M-L1185	751,00
1185	4000K	On/Off	High	5630lm/51W	3,7	LWXOW E-840H-L1185	LWXOE E-840H-L1185	751,00
1478	4000K	On/Off	Medium	5590lm/49W	4,2	LWXOW E-840M-L1478	LWXOE E-840M-L1478	856,00
1478	4000K	On/Off	High	7040lm/62W	4,2	LWXOW E-840H-L1478	LWXOE E-840H-L1478	856,00
1770	4000K	On/Off	Medium	6710lm/57W	4,8	LWXOW E-840M-L1770	LWXOE E-840M-L1770	1014,00
1770	4000K	On/Off	High	8450lm/73W	4,8	LWXOW E-840H-L1770	LWXOE E-840H-L1770	1014,00
2060	4000K	On/Off	Medium	7830lm/70W	6,0	LWXOW E-840M-L2060	LWXOE E-840M-L2060	1224,00
2060	4000K	On/Off	High	9860lm/90W	6,0	LWXOW E-840H-L2060	LWXOE E-840H-L2060	1224,00
per meter	4000K	On/Off	Medium	3810lm/32,6W	3,3	LWXOW E-840M-L****	LWXOE E-840M-L****	552,00
per meter	4000K	On/Off	High	4790lm/41,6W	3,3	LWXOW E-840H-L****	LWXOE E-840H-L****	552,00
per meter	4000K	DALI	Medium	3810lm/32,6W	3,3	LWXOW L-840M-L****	LWXOE L-840M-L****	622,00
per meter	4000K	DALI	High	4790lm/41,6W	3,3	LWXOW L-840H-L****	LWXOE L-840H-L****	622,00

**** - your length in mm

Asymmetrical | Direct-Indirect

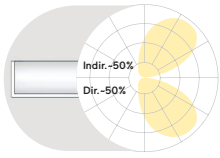

L mm	Colour Temperature	Control	Power	Lumen/Watt	Weight kg	Code Snow White	Code Silver Anodised	CHF
600	4000K	On/Off	Low	1140lm/14W	2,5	LWXGWE-840E-L600	LWXGEE-840E-L600	727,00
600	4000K	On/Off	High	2200lm/27W	2,5	LWXGWE-840H-L600	LWXGEE-840H-L600	727,00
895	4000K	On/Off	Low	1720lm/20W	3,3	LWXGWE-840E-L895	LWXGEE-840E-L895	758,00
895	4000K	On/Off	High	3300lm/39W	3,3	LWXGWE-840H-L895	LWXGEE-840H-L895	758,00
1185	4000K	On/Off	Low	2290lm/26W	4,1	LWXGWE-840E-L1185	LWXGEE-840E-L1185	798,00
1185	4000K	On/Off	High	4400lm/53W	4,1	LWXGWE-840H-L1185	LWXGEE-840H-L1185	798,00
1478	4000K	On/Off	Low	2860lm/32W	4,8	LWXGWE-840E-L1478	LWXGEE-840E-L1478	907,00
1478	4000K	On/Off	High	5500lm/65W	4,8	LWXGWE-840H-L1478	LWXGEE-840H-L1478	907,00
1770	4000K	On/Off	Low	3430lm/38W	5,6	LWXGWE-840E-L1770	LWXGEE-840E-L1770	1101,00
1770	4000K	On/Off	High	6600lm/76W	5,6	LWXGWE-840H-L1770	LWXGEE-840H-L1770	1101,00
2060	4000K	On/Off	Low	4000lm/46W	6,9	LWXGWE-840E-L2060	LWXGEE-840E-L2060	1364,00
2060	4000K	On/Off	High	7700lm/93W	6,9	LWXGWE-840H-L2060	LWXGEE-840H-L2060	1364,00
per meter	4000K	On/Off	Low	1950lm/21,3W	3,6	LWXGWE-840E-L****	LWXGEE-840E-L****	622,00
per meter	4000K	On/Off	High	3740lm/43,3W	3,6	LWXGWE-840H-L****	LWXGEE-840H-L****	622,00
per meter	4000K	DALI	Low	1950lm/21,3W	3,6	LWXGWL-840E-L****	LWXGEL-840E-L****	692,00
per meter	4000K	DALI	High	3740lm/43,3W	3,6	LWXGWL-840H-L****	LWXGEL-840H-L****	692,00



90° Corner
Opal/Microprismatic



Laser Cut-Out



Midpin Spotlight XM
770lm/10W/Ø40mm



48V Track



Multisensor

Surcharges

Surface Finish	CHF	Control Gear	CHF	CHF	Colour Rendering	CHF	Colour Temperature	CHF	Additional Options	CHF
W: Snow White	✓	E: On/Off	✓	✓	8: CRI>80	✓	22: 2200K	+5%	90° Corner	ⓘ
V: Ivory White	✓	L: DALI	+172,00	+343,00	9: CRI>90	+5%	27: 2700K	+5%	Laser Cut-Out	ⓘ
E: Silver Anodised	✓	H: Touch-Dim	+172,00	+343,00	F: Full Spectrum	+15%	30: 3000K	✓	Midpin Spotlight XM	+363,00
U: Urban Graphite	✓	C: Casambi*	+261,00	+261,00			35: 3500K	+5%	48V Track	ⓘ
B: Jet Black	✓	6: DALI DT6 for TW	+343,00	+686,00			40: 4000K	✓	Multisensor	+261,00
H: Anodic Champagne	+10%	8: DALI DT8 for TW	+343,00	+686,00			65: 6500K	+5%	[L1185-L2060]	
K: Satin Copper	+15%						TW: Tunable White 2700-6500K*	+30%	Emergency Module	+366,00
R: Special RAL/NCS Colours	ⓘ	*Only in combination with DALI. Please add to dimming price.							[DALI, Autotest, incl. 3H Battery]	
									[L1185-L2060]	

✓ standard / no extra charge ⓘ on request ✗ not available
 *Only in combination with DT6, DT8 or Casambi control. Please add additional control price.

Matric DX | System 40 mm Wall

catalogue page 162

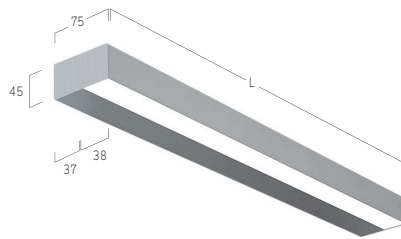
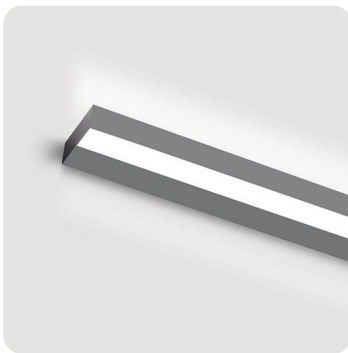

Microprismatic | Direct

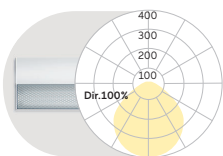

L mm	Colour Temperature	Control	Power	Lumen/Watt	Weight kg	Code Snow White	Code Silver Anodised	CHF
890	4000K	On/Off	Medium	1230lm/21W	2,0	LDXAW E-840M-L890	LDXAE E-840M-L890	590,00
890	4000K	On/Off	High	1780lm/31W	2,0	LDXAW E-840H-L890	LDXAE E-840H-L890	590,00
1182	4000K	On/Off	Medium	1640lm/27W	2,5	LDXAW E-840M-L1182	LDXAE E-840M-L1182	636,00
1182	4000K	On/Off	High	2370lm/41W	2,5	LDXAW E-840H-L1182	LDXAE E-840H-L1182	636,00
1475	4000K	On/Off	Medium	2050lm/33W	3,0	LDXAW E-840M-L1475	LDXAE E-840M-L1475	681,00
1475	4000K	On/Off	High	2960lm/51W	3,0	LDXAW E-840H-L1475	LDXAE E-840H-L1475	681,00
1765	4000K	On/Off	Medium	2460lm/39W	3,5	LDXAW E-840M-L1765	LDXAE E-840M-L1765	797,00
1765	4000K	On/Off	High	3560lm/60W	3,5	LDXAW E-840H-L1765	LDXAE E-840H-L1765	797,00
2055	4000K	On/Off	Medium	2870lm/48W	4,3	LDXAW E-840M-L2055	LDXAE E-840M-L2055	966,00
2055	4000K	On/Off	High	4150lm/72W	4,3	LDXAW E-840H-L2055	LDXAE E-840H-L2055	966,00
per meter	4000K	On/Off	Medium	1400lm/22,0W	2,3	LDXAW E-840M-L****	LDXAE E-840M-L****	473,00
per meter	4000K	On/Off	High	2020lm/33,9W	2,3	LDXAW E-840H-L****	LDXAE E-840H-L****	473,00
per meter	4000K	DALI	Medium	1400lm/22,0W	2,3	LDXAW L-840M-L****	LDXAE L-840M-L****	525,00
per meter	4000K	DALI	High	2020lm/33,9W	2,3	LDXAW L-840H-L****	LDXAE L-840H-L****	525,00

**** - your length in mm

... Matric DX | System 40mm Wall

Opal Diffuser | Direct

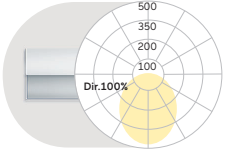

L mm	Colour Temperature	Control	Power	Lumen/Watt	Weight kg	Code Snow White	Code Silver Anodised	CHF
890	4000K	On/Off	Medium	1450lm/21W	2,0	LDXOWE-840M-L890	LDXOEE-840M-L890	574,00
890	4000K	On/Off	High	2080lm/31W	2,0	LDXOWE-840H-L890	LDXOEE-840H-L890	574,00
1182	4000K	On/Off	Medium	1930lm/27W	2,5	LDXOWE-840M-L1182	LDXOEE-840M-L1182	615,00
1182	4000K	On/Off	High	2770lm/41W	2,5	LDXOWE-840H-L1182	LDXOEE-840H-L1182	615,00
1475	4000K	On/Off	Medium	2410lm/33W	3,0	LDXOWE-840M-L1475	LDXOEE-840M-L1475	655,00
1475	4000K	On/Off	High	3460lm/51W	3,0	LDXOWE-840H-L1475	LDXOEE-840H-L1475	655,00
1765	4000K	On/Off	Medium	2900lm/39W	3,5	LDXOWE-840M-L1765	LDXOEE-840M-L1765	767,00
1765	4000K	On/Off	High	4160lm/60W	3,5	LDXOWE-840H-L1765	LDXOEE-840H-L1765	767,00
2055	4000K	On/Off	Medium	3380lm/48W	4,3	LDXOWE-840M-L2055	LDXOEE-840M-L2055	928,00
2055	4000K	On/Off	High	4850lm/72W	4,3	LDXOWE-840H-L2055	LDXOEE-840H-L2055	928,00
per meter	4000K	On/Off	Medium	1640lm/22,0W	2,3	LDXOWE-840M-L****	LDXOEE-840M-L****	455,00
per meter	4000K	On/Off	High	2360lm/33,9W	2,3	LDXOWE-840H-L****	LDXOEE-840H-L****	455,00
per meter	4000K	DALI	Medium	1640lm/22,0W	2,3	LDXOWL-840M-L****	LDXOEL-840M-L****	508,00
per meter	4000K	DALI	High	2360lm/33,9W	2,3	LDXOWL-840H-L****	LDXOEL-840H-L****	508,00

Surcharges

Surface Finish

Surface Finish	CHF
W: Snow White	✓
E: Silver Anodised	✓
U: Urban Graphite	✓
B: Jet Black	✓
H: Anodic Champagne	+10%
K: Satin Copper	+15%
R: Special RAL/NCS Colours	🔔

Control Gear

Control Gear	CHF L890-L1765	CHF L2055
E: On/Off	✓	✓
L: DALI	+86,00	+172,00
H: Touch-Dim	+86,00	+172,00
C: Casambi*	+261,00	+261,00

*Only in combination with DALI. Please add to dimming price.

Colour Rendering

Colour Rendering	CHF
8: CRI>80	✓
9: CRI>90	+5%
F: Full Spectrum	+15%

Colour Temperature

Colour Temperature	CHF
22: 2200K	+5%
27: 2700K	+5%
30: 3000K	✓
35: 3500K	+5%
40: 4000K	✓
65: 6500K	+5%

Additional Options

Additional Options	CHF
Emergency Module [DALI, Autotest, incl. 3H Battery] [L1475-L2055]	+366,00

✓ standard / no extra charge 🔔 on request ✗ not available

Matric JX | System 40mm Wall

catalogue page 164

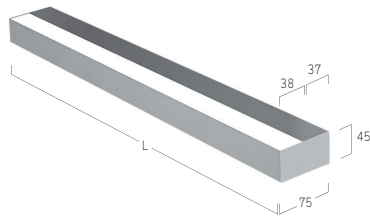
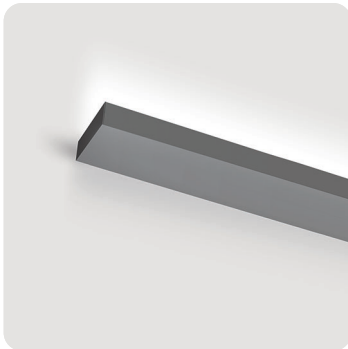

Microprismatic | Indirect

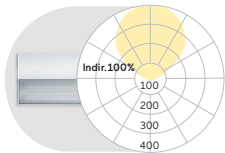

L mm	Colour Temperature	Control	Power	Lumen/Watt	Weight kg	Code Snow White	Code Silver Anodised	CHF
890	4000K	On/Off	Medium	1230lm/21W	1,8	LJXAWE-840M-L890	LJXAAE-840M-L890	564,00
890	4000K	On/Off	High	1780lm/31W	1,8	LJXAWE-840H-L890	LJXAAE-840H-L890	564,00
1182	4000K	On/Off	Medium	1640lm/27W	2,3	LJXAWE-840M-L1182	LJXAAE-840M-L1182	601,00
1182	4000K	On/Off	High	2370lm/41W	2,3	LJXAWE-840H-L1182	LJXAAE-840H-L1182	601,00
1475	4000K	On/Off	Medium	2050lm/33W	2,7	LJXAWE-840M-L1475	LJXAAE-840M-L1475	636,00
1475	4000K	On/Off	High	2960lm/51W	2,7	LJXAWE-840H-L1475	LJXAAE-840H-L1475	636,00
1765	4000K	On/Off	Medium	2460lm/39W	3,1	LJXAWE-840M-L1765	LJXAAE-840M-L1765	739,00
1765	4000K	On/Off	High	3560lm/60W	3,1	LJXAWE-840H-L1765	LJXAAE-840H-L1765	739,00
2055	4000K	On/Off	Medium	2870lm/48W	3,8	LJXAWE-840M-L2055	LJXAAE-840M-L2055	898,00
2055	4000K	On/Off	High	4150lm/72W	3,8	LJXAWE-840H-L2055	LJXAAE-840H-L2055	898,00
per meter	4000K	On/Off	Medium	1400lm/22,0W	2,1	LJXAWE-840M-L****	LJXAAE-840M-L****	447,00
per meter	4000K	On/Off	High	2020lm/33,9W	2,1	LJXAWE-840H-L****	LJXAAE-840H-L****	447,00
per meter	4000K	DALI	Medium	1400lm/22,0W	2,1	LJXAWL-840M-L****	LJXAEEL-840M-L****	499,00
per meter	4000K	DALI	High	2020lm/33,9W	2,1	LJXAWL-840H-L****	LJXAEEL-840H-L****	499,00

**** - your length in mm

Surcharges

Surface Finish

Surface Finish	CHF
W: Snow White	✓
E: Silver Anodised	✓
U: Urban Graphite	✓
B: Jet Black	✓
H: Anodic Champagne	+10%
K: Satin Copper	+15%
R: Special RAL/NCS Colours	🔔

Control Gear

Control Gear	CHF L890-L1765	CHF L2055
E: On/Off	✓	✓
L: DALI	+86,00	+172,00
H: Touch-Dim	+86,00	+172,00
C: Casambi*	+261,00	+261,00

*Only in combination with DALI. Please add to dimming price.

Colour Rendering

Colour Rendering	CHF
8: CRI>80	✓
9: CRI>90	+5%
F: Full Spectrum	+15%

Colour Temperature

Colour Temperature	CHF
22: 2200K	+5%
27: 2700K	+5%
30: 3000K	✓
35: 3500K	+5%
40: 4000K	✓
65: 6500K	+5%

Additional Options

Additional Options	CHF
Emergency Module [DALI, Autotest, incl. 3H Battery] [L1475-L2055]	+366,00

✓ standard / no extra charge 🔔 on request ✗ not available

Matric W4 | System 55 mm Wall

catalogue page 166

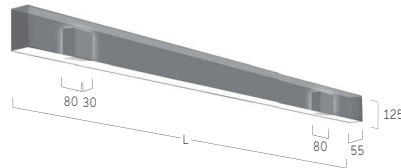

Microprismatic | Direct-Indirect

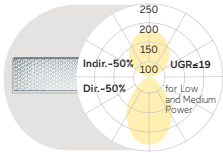

L mm	Colour Temperature	Control	Power	Lumen/Watt	Weight kg	Code Snow White	Code Silver Anodised	CHF
890	4000K	Sep. Switch.	Low	2370lm/22W	4,4	LW4AWG-840E-L890	LW4AEG-840E-L890	863,00
890	4000K	Sep. Switch.	Medium	3260lm/30W	4,4	LW4AWG-840M-L890	LW4AEG-840M-L890	863,00
890	4000K	Sep. Switch.	High	4540lm/42W	4,4	LW4AWG-840H-L890	LW4AEG-840H-L890	863,00
1182	4000K	Sep. Switch.	Low	3200lm/28W	5,5	LW4AWG-840E-L1182	LW4AEG-840E-L1182	900,00
1182	4000K	Sep. Switch.	Medium	4410lm/39W	5,5	LW4AWG-840M-L1182	LW4AEG-840M-L1182	900,00
1182	4000K	Sep. Switch.	High	6140lm/55W	5,5	LW4AWG-840H-L1182	LW4AEG-840H-L1182	900,00
1475	4000K	Sep. Switch.	Low	4040lm/35W	6,5	LW4AWG-840E-L1475	LW4AEG-840E-L1475	947,00
1475	4000K	Sep. Switch.	Medium	5560lm/48W	6,5	LW4AWG-840M-L1475	LW4AEG-840M-L1475	947,00
1475	4000K	Sep. Switch.	High	7750lm/68W	6,5	LW4AWG-840H-L1475	LW4AEG-840H-L1475	947,00
1765	4000K	Sep. Switch.	Low	4870lm/41W	7,6	LW4AWG-840E-L1765	LW4AEG-840E-L1765	1126,00
1765	4000K	Sep. Switch.	Medium	6710lm/56W	7,6	LW4AWG-840M-L1765	LW4AEG-840M-L1765	1126,00
1765	4000K	Sep. Switch.	High	9350lm/81W	7,6	LW4AWG-840H-L1765	LW4AEG-840H-L1765	1126,00
2055	4000K	Sep. Switch.	Low	5700lm/50W	9,1	LW4AWG-840E-L2055	LW4AEG-840E-L2055	1360,00
2055	4000K	Sep. Switch.	Medium	7860lm/69W	9,1	LW4AWG-840M-L2055	LW4AEG-840M-L2055	1360,00
2055	4000K	Sep. Switch.	High	10960lm/98W	9,1	LW4AWG-840H-L2055	LW4AEG-840H-L2055	1360,00
per meter	4000K	Sep. Switch.	Low	2760lm/23,1W	4,8	LW4AWG-840E-L****	LW4AEG-840E-L****	657,00
per meter	4000K	Sep. Switch.	Medium	3810lm/32,0W	4,8	LW4AWG-840M-L****	LW4AEG-840M-L****	657,00
per meter	4000K	Sep. Switch.	High	5300lm/45,9W	4,8	LW4AWG-840H-L****	LW4AEG-840H-L****	657,00
per meter	4000K	Sep. Dim. DALI	Low	2760lm/23,1W	4,8	LW4AWU-840E-L****	LW4AEU-840E-L****	727,00
per meter	4000K	Sep. Dim. DALI	Medium	3810lm/32,0W	4,8	LW4AWU-840M-L****	LW4AEU-840M-L****	727,00
per meter	4000K	Sep. Dim. DALI	High	5300lm/45,9W	4,8	LW4AWU-840H-L****	LW4AEU-840H-L****	727,00

Opal Diffuser | Direct-Indirect

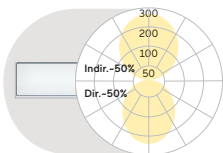

L mm	Colour Temperature	Control	Power	Lumen/Watt	Weight kg	Code Snow White	Code Silver Anodised	CHF
890	4000K	Sep. Switch.	Low	2490lm/22W	4,5	LW4OWG-840E-L890	LW4OEG-840E-L890	826,00
890	4000K	Sep. Switch.	Medium	3420lm/30W	4,5	LW4OWG-840M-L890	LW4OEG-840M-L890	826,00
890	4000K	Sep. Switch.	High	4770lm/42W	4,5	LW4OWG-840H-L890	LW4OEG-840H-L890	826,00
1182	4000K	Sep. Switch.	Low	3350lm/28W	5,7	LW4OWG-840E-L1182	LW4OEG-840E-L1182	874,00
1182	4000K	Sep. Switch.	Medium	4630lm/39W	5,7	LW4OWG-840M-L1182	LW4OEG-840M-L1182	874,00
1182	4000K	Sep. Switch.	High	6450lm/55W	5,7	LW4OWG-840H-L1182	LW4OEG-840H-L1182	874,00
1475	4000K	Sep. Switch.	Low	4230lm/35W	6,7	LW4OWG-840E-L1475	LW4OEG-840E-L1475	917,00
1475	4000K	Sep. Switch.	Medium	5820lm/48W	6,7	LW4OWG-840M-L1475	LW4OEG-840M-L1475	917,00
1475	4000K	Sep. Switch.	High	8130lm/68W	6,7	LW4OWG-840H-L1475	LW4OEG-840H-L1475	917,00
1765	4000K	Sep. Switch.	Low	5110lm/41W	7,8	LW4OWG-840E-L1765	LW4OEG-840E-L1765	1077,00
1765	4000K	Sep. Switch.	Medium	7030lm/56W	7,8	LW4OWG-840M-L1765	LW4OEG-840M-L1765	1077,00
1765	4000K	Sep. Switch.	High	9810lm/81W	7,8	LW4OWG-840H-L1765	LW4OEG-840H-L1765	1077,00
2055	4000K	Sep. Switch.	Low	5980lm/50W	9,3	LW4OWG-840E-L2055	LW4OEG-840E-L2055	1304,00
2055	4000K	Sep. Switch.	Medium	8240lm/69W	9,3	LW4OWG-840M-L2055	LW4OEG-840M-L2055	1304,00
2055	4000K	Sep. Switch.	High	11490lm/98W	9,3	LW4OWG-840H-L2055	LW4OEG-840H-L2055	1304,00
per meter	4000K	Sep. Switch.	Low	2900lm/23,1W	4,9	LW4OWG-840E-L****	LW4OEG-840E-L****	639,00
per meter	4000K	Sep. Switch.	Medium	3990lm/32,0W	4,9	LW4OWG-840M-L****	LW4OEG-840M-L****	639,00
per meter	4000K	Sep. Switch.	High	5560lm/45,9W	4,9	LW4OWG-840H-L****	LW4OEG-840H-L****	639,00
per meter	4000K	Sep. Dim. DALI	Low	2900lm/23,1W	4,9	LW4OWU-840E-L****	LW4OEU-840E-L****	709,00
per meter	4000K	Sep. Dim. DALI	Medium	3990lm/32,0W	4,9	LW4OWU-840M-L****	LW4OEU-840M-L****	709,00
per meter	4000K	Sep. Dim. DALI	High	5560lm/45,9W	4,9	LW4OWU-840H-L****	LW4OEU-840H-L****	709,00

Asymmetrical | Direct-Indirect

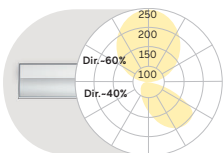

L mm	Colour Temperature	Control	Power	Lumen/Watt	Weight kg	Code Snow White	Code Silver Anodised	CHF
890	4000K	Sep. Switch.	Medium	2730lm/26W	3,5	LW4GWG-840M-L890	LW4GEG-840M-L890	900,00
890	4000K	Sep. Switch.	High	3730lm/37W	3,5	LW4GWG-840H-L890	LW4GEG-840H-L890	900,00
1182	4000K	Sep. Switch.	Medium	3700lm/37W	5,0	LW4GWG-840M-L1182	LW4GEG-840M-L1182	947,00
1182	4000K	Sep. Switch.	High	5070lm/51W	5,0	LW4GWG-840H-L1182	LW4GEG-840H-L1182	947,00
1475	4000K	Sep. Switch.	Medium	4670lm/45W	6,5	LW4GWG-840M-L1475	LW4GEG-840M-L1475	1003,00
1475	4000K	Sep. Switch.	High	6400lm/63W	6,5	LW4GWG-840H-L1475	LW4GEG-840H-L1475	1003,00
1765	4000K	Sep. Switch.	Medium	5640lm/54W	8,0	LW4GWG-840M-L1765	LW4GEG-840M-L1765	1190,00
1765	4000K	Sep. Switch.	High	7740lm/75W	8,0	LW4GWG-840H-L1765	LW4GEG-840H-L1765	1190,00
2055	4000K	Sep. Switch.	Medium	6620lm/65W	9,0	LW4GWG-840M-L2055	LW4GEG-840M-L2055	1455,00
2055	4000K	Sep. Switch.	High	9070lm/91W	9,0	LW4GWG-840H-L2055	LW4GEG-840H-L2055	1455,00
per meter	4000K	Sep. Switch.	Medium	3200lm/30,4W	4,9	LW4GWG-840M-L****	LW4GEG-840M-L****	683,00
per meter	4000K	Sep. Switch.	High	4390lm/42,7W	4,9	LW4GWG-840H-L****	LW4GEG-840H-L****	683,00
per meter	4000K	Sep. Dim. DALI	Medium	3200lm/30,4W	4,9	LW4GWU-840M-L****	LW4GEU-840M-L****	753,00
per meter	4000K	Sep. Dim. DALI	High	4390lm/42,7W	4,9	LW4GWU-840H-L****	LW4GEU-840H-L****	753,00

**** - your length in mm



Surcharges		Surface Finish		Control Gear		Colour Temperature		Additional Options	
Optical System	CHF		CHF		CHF		CHF		CHF
O: Opal Diffuser (PMMA)	✓	W: Snow White	✓	G: Separately Switchable	L890-L1765	22: 2200K	+5%	90° Corner	ⓘ
D: Opal Diffuser Polycarbonate*	+5%	E: Silver Anodised	✓	U: Separately Dimmable DALI	+172,00	27: 2700K	+5%	Midpin Downlight XD	+363,00
*Opal Diffuser made of sustainable Trucircle Polycarbonate / Fire Rated - Glow wire flammability Index 950°C EN60695-2-12 / Tp(a). Luminous flux reduction of 10%.		U: Urban Graphite	✓	6: DALI DT6 for TW	+343,00	30: 3000K	✓	Midpin Spotlight XM	+363,00
		B: Jet Black	✓	8: DALI DT8 for TW	+343,00	35: 3500K	+5%	3-Phase Track	ⓘ
		H: Anodic Champagne	+10%	Colour Rendering	CHF	40: 4000K	✓	Multisensor [L1185-L2060]	+261,00
		K: Satin Copper	+15%	8: CRI>80	✓	65: 6500K	+5%	Emergency Module [DALI, Autotest, incl. 3H Battery] [L1185-L2060]	+366,00
		R: Special RAL/NCS Colours	ⓘ	9: CRI>90	+5%	TW: Tunable White 2700-6500K*	+30%		
				F: Full Spectrum	+15%				

✓ standard / no extra charge
ⓘ on request
✗ not available

*Only in combination with DT6, DT8 or Casambi control. Please add additional control price.

Matric W6 | System 81mm Wall

catalogue page 168

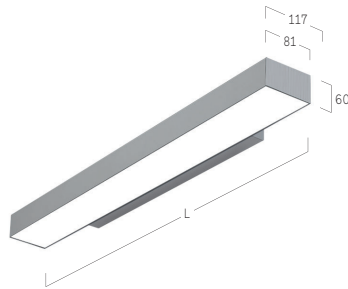

Micropismatic | Direct-Indirect

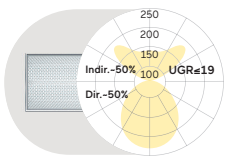

L mm	Colour Temperature	Control	Power	Lumen/Watt	Weight kg	Code Snow White	Code Silver Anodised	CHF
890	4000K	On/Off	Medium	4080lm/34W	3,7	LW6AWE-840M-L890	LW6AEE-840M-L890	826,00
890	4000K	On/Off	High	5520lm/46W	3,7	LW6AWE-840H-L890	LW6AEE-840H-L890	826,00
1182	4000K	On/Off	Medium	5440lm/44W	4,5	LW6AWE-840M-L1182	LW6AEE-840M-L1182	881,00
1182	4000K	On/Off	High	7370lm/61W	4,5	LW6AWE-840H-L1182	LW6AEE-840H-L1182	881,00
1475	4000K	On/Off	Medium	6800lm/54W	5,3	LW6AWE-840M-L1475	LW6AEE-840M-L1475	973,00
1475	4000K	On/Off	High	9210lm/74W	5,3	LW6AWE-840H-L1475	LW6AEE-840H-L1475	973,00

Opal Diffuser | Direct-Indirect

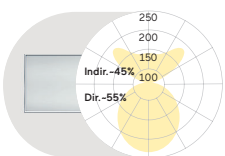

L mm	Colour Temperature	Control	Power	Lumen/Watt	Weight kg	Code Snow White	Code Silver Anodised	CHF
890	4000K	On/Off	Medium	4530lm/34W	3,7	LW6OWE-840M-L890	LW6OEE-840M-L890	807,00
890	4000K	On/Off	High	6140lm/46W	3,7	LW6OWE-840H-L890	LW6OEE-840H-L890	807,00
1182	4000K	On/Off	Medium	6050lm/44W	4,5	LW6OWE-840M-L1182	LW6OEE-840M-L1182	856,00
1182	4000K	On/Off	High	8190lm/61W	4,5	LW6OWE-840H-L1182	LW6OEE-840H-L1182	856,00
1475	4000K	On/Off	Medium	7560lm/54W	5,3	LW6OWE-840M-L1475	LW6OEE-840M-L1475	937,00
1475	4000K	On/Off	High	10230lm/74W	5,3	LW6OWE-840H-L1475	LW6OEE-840H-L1475	937,00

Wallwasher | Direct-Indirect

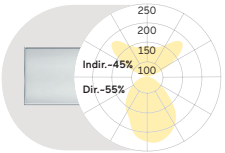

L mm	Colour Temperature	Control	Power	Lumen/Watt	Weight kg	Code Snow White	Code Silver Anodised	CHF
890	4000K	On/Off	Medium	4180lm/34W	3,7	LW6JWE-840M-L890	LW6JEE-840M-L890	853,00
890	4000K	On/Off	High	5660lm/46W	3,7	LW6JWE-840H-L890	LW6JEE-840H-L890	853,00
1182	4000K	On/Off	Medium	5570lm/44W	4,5	LW6JWE-840M-L1182	LW6JEE-840M-L1182	909,00
1182	4000K	On/Off	High	7550lm/61W	4,5	LW6JWE-840H-L1182	LW6JEE-840H-L1182	909,00
1475	4000K	On/Off	Medium	6970lm/54W	5,3	LW6JWE-840M-L1475	LW6JEE-840M-L1475	1003,00
1475	4000K	On/Off	High	9430lm/74W	5,3	LW6JWE-840H-L1475	LW6JEE-840H-L1475	1003,00

Surcharges

Surface Finish	CHF	Control Gear	CHF	Colour Rendering	CHF	Colour Temperature	CHF
W: Snow White	✓	E: On/Off	✓	8: CRI>80	✓	22: 2200K	+5%
E: Silver Anodised	✓	L: DALI	+86,00	9: CRI>90	+5%	27: 2700K	+5%
U: Urban Graphite	✓	H: Touch-Dim	+86,00	F: Full Spectrum	+15%	30: 3000K	✓
B: Jet Black	✓	C: Casambi*	+261,00			35: 3500K	+5%
H: Anodic Champagne	+10%	8: DALI DT8 for TW [L1182-L1475]	+172,00			40: 4000K	✓
K: Satin Copper	+15%					65: 6500K	+5%
R: Special RAL/NCS Colours	📌					TW: Tunable White 2700-6500K*	+30%

*Only in combination with DALI.
Please add to dimming price.

*Only in combination with DT8 or Casambi control. Please add additional control price.

✓ standard / no extra charge 📌 on request ✗ not available



Midpin G3 |
Single Suspended
54

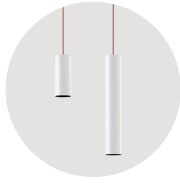

Midpoint P7/P8 |
Suspended
54



Basic Superflat G7/P7 |
Suspended
55



Basic Neo G5/P5 |
Suspended
56



Basic Déco G3/P3 |
Suspended
57



Basic Déco XXL G4/P4 |
Suspended
58



Basic Déco O3 |
Suspended
60



Basic Max G1/P1 |
Suspended
60



Basic Visio G9/P9 |
Suspended
62



Beam Me Up (Flat)
G3/P3 | Suspended
63



Beam Me Up (Max)
G1/P1 | Suspended
64



Ringo Star Compact
G5/P5 | Suspended
65



Ringo Star GY/PY |
System 40mm Suspended
66



Ringo Star GX/PX |
System 40mm Suspended
67



Ringo Star Acoustic GY/PY |
System 40mm Suspended
68



Ringo Star G3/P3 |
System 60mm Suspended
69



Ringo Star Acoustic G3/P3 |
System 60mm Suspended
70



Ringo Star G1/P1 |
System 100mm Suspended
72



Ringo Star Acoustic G1/P1 |
System 100mm Suspended
74



Ringo Star Chandelier
G1/P1 | Suspended
75



Ringo Star Cluster G3/P3 |
Suspended
78



Ringo Star Chain G3/P3 |
Suspended
79



Ringo Star Oblong
GX/PX | Suspended
80



Liquid Line Compact
G5/P5 | Suspended
81



Liquid Line GX/PX |
System 40mm Suspended
82



Liquid Line G3/P3 |
System 60mm Suspended
84



Code Zero G3/P3 |
Suspended
86



Caleo Inverse GX/PX |
System 40mm Suspended
87



Caleo Neo G4/P4 |
Suspended
88



Caleo Neo G6/P6 |
Suspended
89



Cubic Evolution G4/P4 |
200mm Suspended
90



Cubic Evolution G5/P5 |
300mm Suspended
91



Cubic Evolution G6/P6 |
Square Suspended
92



Cubic Evolution G4/P4 |
System Suspended
93



Cubic Evolution U4 |
Suspended
94



Cubic Max G2/P2 |
Suspended
95



Cubic Ambient G7/P7 |
Suspended
96



Cubic Déco G3/P3 |
Suspended
97

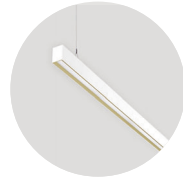

Matric Déco G9/R9 |
Suspended
98



Matric RY | System
40mm Suspended
100

Pendel | Suspended | Suspension

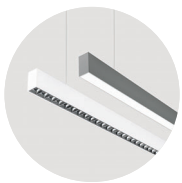

Matric GX/RX | System
40mm Suspended
100

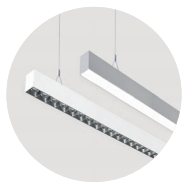

Matric G3/R3 | System
55mm Suspended
103

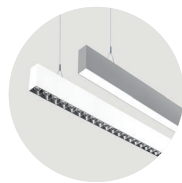

Matric R4 | System
55mm Suspended
105



Matric G5 | System
81mm Suspended
107

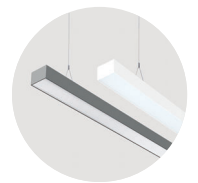

Matric G6/R6 | System
81mm Suspended
109



Matric Square GX/RX |
System 40mm Suspended
111



Matric Square Acoustic GX/RX |
System 40mm Suspended
113



Vision Gen. 4 G4/P4 |
Suspended
114



Plank G4/P4 |
Suspended
117

Midpin G3 | Single Suspended

catalogue page 172



Led Engine - Eco:

Beam Angle	Colour Temperature	Control	Power	Lumen/Watt	Weight kg	Code Snow White	Code Jet Black	CHF
Medium 30°	4000K	On/Off	Medium	750lm/11W	1,0	DG3BWE-940M-WT	DG3BBE-940M-BT	427,00
Flood 40°	4000K	On/Off	Medium	770lm/11W	1,0	DG3CWE-940M-WT	DG3CBE-940M-BT	427,00

Surcharges

Surface	CHF	Control Gear	CHF	Colour Temperature	CHF	Optic Ring	CHF	Cable Colour	CHF
W: Snow White	✓	E: On/Off	✓	27: 2700K	+5%	W: Snow White	✓	T: Transparent	✓
V: Ivory White	✓	L: DALI	+86,00	30: 3000K	✓	V: Ivory White	✓	R: Red	+14,00
S: Radiant Silver	✓	H: Touch-Dim	+86,00	35: 3500K	+5%	S: Radiant Silver	✓	B: Black	+14,00
B: Jet Black	✓			40: 4000K	✓	B: Jet Black	✓		
H: Anodic Champagne	+10%			DW: Dim to Warm 3000K-1800K	+15%	H: Anodic Champagne	✓		
R: Special RAL/NCS Colours	ⓘ					K: Satin Copper	✓		
						G: Satin Gold	✓		

✓ standard / no extra charge ⓘ on request ✗ not available

Midpoint P7/P8 | Suspended

catalogue page 176

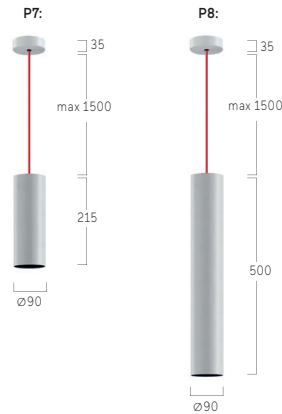
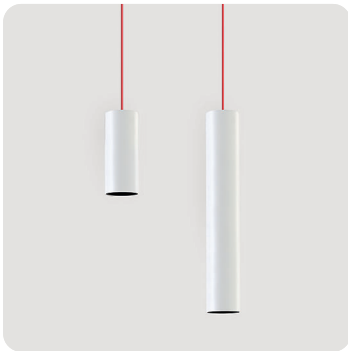

Led Engine - Eco:

Beam Angle	Colour Temperature	Control	Power	Lumen/Watt	Weight kg	Code Snow White	Code Radiant Silver	CHF
Spot 10°	4000K	On/Off	Low	1440lm/19W	1,4	PP7AWE-940FE-WKT	PP7ASE-940FE-SKT	406,00
Spot 10°	4000K	On/Off	Low	1440lm/19W	2,8	PP8AWE-940FE-WKT	PP8ASE-940FE-SKT	452,00
Spot 10°	4000K	On/Off	Medium	2020lm/31W	1,4	PP7AWE-940FM-WKT	PP7ASE-940FM-SKT	406,00
Spot 10°	4000K	On/Off	Medium	2020lm/31W	2,8	PP8AWE-940FM-WKT	PP8ASE-940FM-SKT	452,00
Medium 20°	4000K	On/Off	Low	1850lm/19W	1,4	PP7BWE-940FE-WKT	PP7BSE-940FE-SKT	382,00
Medium 20°	4000K	On/Off	Low	1850lm/19W	2,8	PP8BWE-940FE-WKT	PP8BSE-940FE-SKT	427,00
Medium 20°	4000K	On/Off	Medium	2870lm/31W	1,4	PP7BWE-940FM-WKT	PP7BSE-940FM-SKT	382,00
Medium 20°	4000K	On/Off	Medium	2870lm/31W	2,8	PP8BWE-940FM-WKT	PP8BSE-940FM-SKT	427,00
Flood 35°	4000K	On/Off	Low	1790lm/19W	1,4	PP7CWE-940FE-WKT	PP7CSE-940FE-SKT	377,00
Flood 35°	4000K	On/Off	Low	1790lm/19W	2,8	PP8CWE-940FE-WKT	PP8CSE-940FE-SKT	427,00
Flood 35°	4000K	On/Off	Medium	2780lm/31W	1,4	PP7CWE-940FM-WKT	PP7CSE-940FM-SKT	382,00
Flood 35°	4000K	On/Off	Medium	2780lm/31W	2,8	PP8CWE-940FM-WKT	PP8CSE-940FM-SKT	427,00
W Flood 50°	4000K	On/Off	Low	1680lm/19W	1,4	PP7DWE-940FE-WKT	PP7DSE-940FE-SKT	382,00
W Flood 50°	4000K	On/Off	Low	1680lm/19W	2,8	PP8DWE-940FE-WKT	PP8DSE-940FE-SKT	427,00
W Flood 50°	4000K	On/Off	Medium	2710lm/31W	1,4	PP7DWE-940FM-WKT	PP7DSE-940FM-SKT	382,00
W Flood 50°	4000K	On/Off	Medium	2710lm/31W	2,8	PP8DWE-940FM-WKT	PP8DSE-940FM-SKT	427,00

Led Engine - Artist Xicato:

Beam Angle	Colour Temperature	Control	Power	Lumen/Watt	Weight kg	Code Snow White	Code Radiant Silver	CHF
Spot 10°	4000K	On/Off	Low	1190lm/19W	1,4	PP7AWE-940AE-WKT	PP7ASE-940AE-SKT	550,00
Spot 10°	4000K	On/Off	Low	1190lm/19W	2,8	PP8AWE-940AE-WKT	PP8ASE-940AE-SKT	597,00
Spot 10°	4000K	On/Off	Medium	1560lm/31W	1,4	PP7AWE-940AM-WKT	PP7ASE-940AM-SKT	550,00
Spot 10°	4000K	On/Off	Medium	1560lm/31W	2,8	PP8AWE-940AM-WKT	PP8ASE-940AM-SKT	597,00
Medium 20°	4000K	On/Off	Low	1510lm/19W	1,4	PP7BWE-940AE-WKT	PP7BSE-940AE-SKT	513,00
Medium 20°	4000K	On/Off	Low	1510lm/19W	2,8	PP8BWE-940AE-WKT	PP8BSE-940AE-SKT	560,00
Medium 20°	4000K	On/Off	Medium	2220lm/31W	1,4	PP7BWE-940AM-WKT	PP7BSE-940AM-SKT	513,00
Medium 20°	4000K	On/Off	Medium	2220lm/31W	2,8	PP8BWE-940AM-WKT	PP8BSE-940AM-SKT	560,00
Flood 35°	4000K	On/Off	Low	1470lm/19W	1,4	PP7CWE-940AE-WKT	PP7CSE-940AE-SKT	513,00
Flood 35°	4000K	On/Off	Low	1470lm/19W	2,8	PP8CWE-940AE-WKT	PP8CSE-940AE-SKT	560,00
Flood 35°	4000K	On/Off	Medium	2160lm/31W	1,4	PP7CWE-940AM-WKT	PP7CSE-940AM-SKT	513,00
Flood 35°	4000K	On/Off	Medium	2160lm/31W	2,8	PP8CWE-940AM-WKT	PP8CSE-940AM-SKT	560,00
W Flood 50°	4000K	On/Off	Low	1430lm/19W	1,4	PP7DWE-940AE-WKT	PP7DSE-940AE-SKT	513,00
W Flood 50°	4000K	On/Off	Low	1430lm/19W	2,8	PP8DWE-940AE-WKT	PP8DSE-940AE-SKT	560,00
W Flood 50°	4000K	On/Off	Medium	2140lm/31W	1,4	PP7DWE-940AM-WKT	PP7DSE-940AM-SKT	513,00
W Flood 50°	4000K	On/Off	Medium	2140lm/31W	2,8	PP8DWE-940AM-WKT	PP8DSE-940AM-SKT	560,00

Surcharges

Surface / Reflector Finish	CHF	Control Gear	CHF	Optic Ring	CHF	Cover	CHF	Cable Colour	CHF
W: Snow White	✓	E: On/Off	✓	W: Snow White	✓	K: Clear Cover	✓	T: Transparent	✓
V: Ivory White	✓	L: DALI	+86,00	V: Ivory White	✓	P: Prismatic Lens	+21,00	R: Red	+19,00
S: Radiant Silver	✓	H: Touch-Dim	+86,00	S: Radiant Silver	✓	H: Honeycomb Louvre	+21,00	B: Black	+19,00
U: Urban Graphite	✓			B: Jet Black	✓				
B: Jet Black	✓	Colour Temperature	CHF	H: Anodic Champagne	✓			Additional Options	CHF
H: Anodic Champagne	+10%	27: 2700K	+5%	K: Satin Copper	✓			Optic Removal Tool	34,00
R: Special RAL/NCS Colours	🔴	30: 3000K	✓	G: Satin Gold	✓				
		40: 4000K	✓						

✓ standard / no extra charge 🔴 on request ✗ not available

Basic Superflat G7/P7 | Suspended

catalogue page 180



Microprismatic | Direct-Indirect

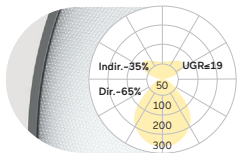

D mm	Colour Temperature	Control	Power	Lumen/Watt	Weight kg	Code Snow White	Code Radiant Silver	CHF
300	4000K	On/Off	Medium	1260lm/11W	2,0	BP7AWE-840M-D300-U	BP7ASE-840M-D300-U	903,00
300	4000K	On/Off	High	2150lm/18W	2,0	BP7AWE-840H-D300-U	BP7ASE-840H-D300-U	903,00
400	4000K	On/Off	Medium	2330lm/18W	3,2	BP7AWE-840M-D400-U	BP7ASE-840M-D400-U	1161,00
400	4000K	On/Off	High	4050lm/31W	3,2	BP7AWE-840H-D400-U	BP7ASE-840H-D400-U	1161,00
500	4000K	On/Off	Medium	3000lm/23W	4,3	BP7AWE-840M-D500-U	BP7ASE-840M-D500-U	1379,00
500	4000K	On/Off	High	5240lm/40W	4,3	BP7AWE-840H-D500-U	BP7ASE-840H-D500-U	1379,00
600	4000K	On/Off	Medium	5380lm/40W	6,0	BP7AWE-840M-D600-U	BP7ASE-840M-D600-U	1728,00
600	4000K	On/Off	High	8270lm/63W	6,0	BP7AWE-840H-D600-U	BP7ASE-840H-D600-U	1728,00
800	4000K	On/Off	Medium	7860lm/60W	9,8	BP7AWE-840M-D800-U	BP7ASE-840M-D800-U	2904,00
800	4000K	On/Off	High	10750lm/81W	9,8	BP7AWE-840H-D800-U	BP7ASE-840H-D800-U	2904,00

Microprismatic | Direct

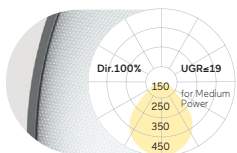

D mm	Colour Temperature	Control	Power	Lumen/Watt	Weight kg	Code Snow White	Code Radiant Silver	CHF
300	4000K	On/Off	Medium	690lm/7W	2,0	BG7AWE-840M-D300-U	BG7ASE-840M-D300-U	763,00
300	4000K	On/Off	High	1190lm/11W	2,0	BG7AWE-840H-D300-U	BG7ASE-840H-D300-U	763,00
400	4000K	On/Off	Medium	1470lm/12W	2,8	BG7AWE-840M-D400-U	BG7ASE-840M-D400-U	1003,00
400	4000K	On/Off	High	2560lm/21W	2,8	BG7AWE-840H-D400-U	BG7ASE-840H-D400-U	1003,00
500	4000K	On/Off	Medium	2030lm/16W	4,3	BG7AWE-840M-D500-U	BG7ASE-840M-D500-U	1204,00
500	4000K	On/Off	High	3570lm/28W	4,3	BG7AWE-840H-D500-U	BG7ASE-840H-D500-U	1204,00
600	4000K	On/Off	Medium	3390lm/25W	5,8	BG7AWE-840M-D600-U	BG7ASE-840M-D600-U	1535,00
600	4000K	On/Off	High	5520lm/42W	5,8	BG7AWE-840H-D600-U	BG7ASE-840H-D600-U	1535,00
800	4000K	On/Off	Medium	5160lm/40W	8,5	BG7AWE-840M-D800-U	BG7ASE-840M-D800-U	2694,00
800	4000K	On/Off	High	6980lm/54W	8,5	BG7AWE-840H-D800-U	BG7ASE-840H-D800-U	2694,00

... Basic Superflat G7/P7 | Suspended

Opal Diffuser | Direct-Indirect

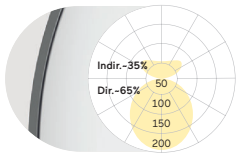

D mm	Colour Temperature	Control	Power	Lumen/Watt	Weight kg	Code Snow White	Code Radiant Silver	CHF
300	4000K	On/Off	Medium	1270lm/11W	2,0	BP7OWE-840M-D300-U	BP7OSE-840M-D300-U	867,00
300	4000K	On/Off	High	2160lm/18W	2,0	BP7OWE-840H-D300-U	BP7OSE-840H-D300-U	867,00
400	4000K	On/Off	Medium	2350lm/18W	3,2	BP7OWE-840M-D400-U	BP7OSE-840M-D400-U	1105,00
400	4000K	On/Off	High	4070lm/31W	3,2	BP7OWE-840H-D400-U	BP7OSE-840H-D400-U	1105,00
500	4000K	On/Off	Medium	3040lm/23W	4,3	BP7OWE-840M-D500-U	BP7OSE-840M-D500-U	1325,00
500	4000K	On/Off	High	5300lm/40W	4,3	BP7OWE-840H-D500-U	BP7OSE-840H-D500-U	1325,00
600	4000K	On/Off	Medium	5450lm/40W	6,0	BP7OWE-840M-D600-U	BP7OSE-840M-D600-U	1654,00
600	4000K	On/Off	High	8370lm/63W	6,0	BP7OWE-840H-D600-U	BP7OSE-840H-D600-U	1654,00
800	4000K	On/Off	Medium	7980lm/60W	9,8	BP7OWE-840M-D800-U	BP7OSE-840M-D800-U	2830,00
800	4000K	On/Off	High	10920lm/81W	9,8	BP7OWE-840H-D800-U	BP7OSE-840H-D800-U	2830,00

Opal Diffuser | Direct

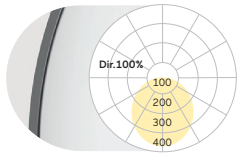

D mm	Colour Temperature	Control	Power	Lumen/Watt	Weight kg	Code Snow White	Code Radiant Silver	CHF
300	4000K	On/Off	Medium	700lm/7W	2,0	BG7OWE-840M-D300-U	BG7OSE-840M-D300-U	727,00
300	4000K	On/Off	High	1200lm/11W	2,0	BG7OWE-840H-D300-U	BG7OSE-840H-D300-U	727,00
400	4000K	On/Off	Medium	1490lm/12W	2,8	BG7OWE-840M-D400-U	BG7OSE-840M-D400-U	947,00
400	4000K	On/Off	High	2580lm/21W	2,8	BG7OWE-840H-D400-U	BG7OSE-840H-D400-U	947,00
500	4000K	On/Off	Medium	2070lm/16W	4,3	BG7OWE-840M-D500-U	BG7OSE-840M-D500-U	1150,00
500	4000K	On/Off	High	3630lm/28W	4,3	BG7OWE-840H-D500-U	BG7OSE-840H-D500-U	1150,00
600	4000K	On/Off	Medium	3460lm/25W	5,8	BG7OWE-840M-D600-U	BG7OSE-840M-D600-U	1462,00
600	4000K	On/Off	High	5620lm/42W	5,8	BG7OWE-840H-D600-U	BG7OSE-840H-D600-U	1462,00
800	4000K	On/Off	Medium	5280lm/40W	8,5	BG7OWE-840M-D800-U	BG7OSE-840M-D800-U	2620,00
800	4000K	On/Off	High	7150lm/54W	8,5	BG7OWE-840H-D800-U	BG7OSE-840H-D800-U	2620,00

Surcharges

Surface Finish	CHF	Control Gear	CHF	CHF	Colour Rendering	CHF	Colour Temperature	CHF	Suspension	CHF
W: Snow White	✓	E: On/Off	✓	✓	8: CRI>80	✓	22: 2200K	+5%	U: Central Suspension	✓
V: Ivory White	✓	L: DALI	+86,00	+172,00	9: CRI>90	+5%	27: 2700K	+5%	P: Tube Suspension	+86,00
S: Radiant Silver	✓	H: Touch-Dim	+86,00	+172,00	F: Full Spectrum	+15%	30: 3000K	✓		
U: Urban Graphite	✓	C: Casambi*	+261,00	+261,00			35: 3500K	+5%	Additional Options	CHF
B: Jet Black	✓	6: DALI DT6 for TW	+172,00	+343,00			40: 4000K	✓	Radar Sensor	+209,00
H: Anodic Champagne	+10%	8: DALI DT8 for TW	+172,00	+343,00			65: 6500K	+5%	Multisensor [D400-D800]	+261,00
K: Satin Copper	+15%						TW: Tunable White 2700-6500K*	+30%	Emergency Module	+366,00
R: Special RAL/NCS Colours	🔴						[D400-D800]		[DALI, Autotest, incl. 3H Battery]	

✓ standard / no extra charge 🔴 on request 🚫 not available

*Only in combination with DALI.
 Please add to dimming price.

*Only in combination with DT6, DT8 or Casambi control. Please add additional control price.

Basic Neo G5/P5 | Suspended

catalogue page **184**



Tube Suspension



Central Cord Suspension



Microprismatic | Direct-Indirect

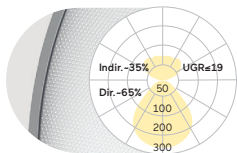

D mm	Colour Temperature	Control	Power	Lumen/Watt	Weight kg	Code Snow White	Code Radiant Silver	CHF
300	4000K	On/Off	Medium	1210lm/11W	2,2	BP5AWE-840M-D300-U	BP5ASE-840M-D300-U	867,00
300	4000K	On/Off	High	2070lm/18W	2,2	BP5AWE-840H-D300-U	BP5ASE-840H-D300-U	867,00
400	4000K	On/Off	Medium	2260lm/18W	3,3	BP5AWE-840M-D400-U	BP5ASE-840M-D400-U	1099,00
400	4000K	On/Off	High	3920lm/31W	3,3	BP5AWE-840H-D400-U	BP5ASE-840H-D400-U	1099,00
500	4000K	On/Off	Medium	2920lm/23W	5,3	BP5AWE-840M-D500-U	BP5ASE-840M-D500-U	1313,00
500	4000K	On/Off	High	5100lm/40W	5,3	BP5AWE-840H-D500-U	BP5ASE-840H-D500-U	1313,00
600	4000K	On/Off	Medium	5210lm/40W	6,4	BP5AWE-840M-D600-U	BP5ASE-840M-D600-U	1651,00
600	4000K	On/Off	High	8040lm/63W	6,4	BP5AWE-840H-D600-U	BP5ASE-840H-D600-U	1651,00
800	4000K	On/Off	Medium	7630lm/60W	9,5	BP5AWE-840M-D800-U	BP5ASE-840M-D800-U	2793,00
800	4000K	On/Off	High	10430lm/81W	9,5	BP5AWE-840H-D800-U	BP5ASE-840H-D800-U	2793,00

Microprismatic | Direct

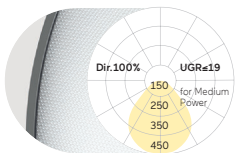

D mm	Colour Temperature	Control	Power	Lumen/Watt	Weight kg	Code Snow White	Code Radiant Silver	CHF
300	4000K	On/Off	Medium	690lm/7W	2,2	BG5AWE-840M-D300-U	BG5ASE-840M-D300-U	727,00
300	4000K	On/Off	High	1190lm/11W	2,2	BG5AWE-840H-D300-U	BG5ASE-840H-D300-U	727,00
400	4000K	On/Off	Medium	1470lm/12W	3,2	BG5AWE-840M-D400-U	BG5ASE-840M-D400-U	942,00
400	4000K	On/Off	High	2560lm/21W	3,2	BG5AWE-840H-D400-U	BG5ASE-840H-D400-U	942,00
500	4000K	On/Off	Medium	2030lm/16W	4,6	BG5AWE-840M-D500-U	BG5ASE-840M-D500-U	1138,00
500	4000K	On/Off	High	3570lm/28W	4,6	BG5AWE-840H-D500-U	BG5ASE-840H-D500-U	1138,00
600	4000K	On/Off	Medium	3390lm/25W	6,2	BG5AWE-840M-D600-U	BG5ASE-840M-D600-U	1458,00
600	4000K	On/Off	High	5520lm/42W	6,2	BG5AWE-840H-D600-U	BG5ASE-840H-D600-U	1458,00
800	4000K	On/Off	Medium	5160lm/40W	9,5	BG5AWE-840M-D800-U	BG5ASE-840M-D800-U	2583,00
800	4000K	On/Off	High	6980lm/54W	9,5	BG5AWE-840H-D800-U	BG5ASE-840H-D800-U	2583,00

Opal Diffuser | Direct-Indirect

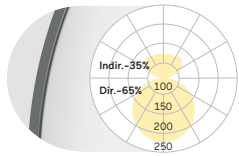

D mm	Colour Temperature	Control	Power	Lumen/Watt	Weight kg	Code Snow White	Code Radiant Silver	CHF
300	4000K	On/Off	Medium	1220lm/11W	2,2	BP50WE-840M-D300-U	BP50SE-840M-D300-U	832,00
300	4000K	On/Off	High	2080lm/18W	2,2	BP50WE-840H-D300-U	BP50SE-840H-D300-U	832,00
400	4000K	On/Off	Medium	2280lm/18W	3,3	BP50WE-840M-D400-U	BP50SE-840M-D400-U	1045,00
400	4000K	On/Off	High	3940lm/31W	3,3	BP50WE-840H-D400-U	BP50SE-840H-D400-U	1045,00
500	4000K	On/Off	Medium	2960lm/23W	5,3	BP50WE-840M-D500-U	BP50SE-840M-D500-U	1259,00
500	4000K	On/Off	High	5160lm/40W	5,3	BP50WE-840H-D500-U	BP50SE-840H-D500-U	1259,00
600	4000K	On/Off	Medium	5280lm/40W	6,4	BP50WE-840M-D600-U	BP50SE-840M-D600-U	1502,00
600	4000K	On/Off	High	8140lm/63W	6,4	BP50WE-840H-D600-U	BP50SE-840H-D600-U	1502,00
800	4000K	On/Off	Medium	7750lm/60W	9,5	BP50WE-840M-D800-U	BP50SE-840M-D800-U	2692,00
800	4000K	On/Off	High	10600lm/81W	9,5	BP50WE-840H-D800-U	BP50SE-840H-D800-U	2692,00

Opal Diffuser | Direct

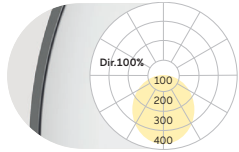

D mm	Colour Temperature	Control	Power	Lumen/Watt	Weight kg	Code Snow White	Code Radiant Silver	CHF
300	4000K	On/Off	Medium	700lm/7W	2,2	BG50WE-840M-D300-U	BG50SE-840M-D300-U	692,00
300	4000K	On/Off	High	1200lm/11W	2,2	BG50WE-840H-D300-U	BG50SE-840H-D300-U	692,00
400	4000K	On/Off	Medium	1490lm/12W	3,2	BG50WE-840M-D400-U	BG50SE-840M-D400-U	888,00
400	4000K	On/Off	High	2580lm/21W	3,2	BG50WE-840H-D400-U	BG50SE-840H-D400-U	888,00
500	4000K	On/Off	Medium	2070lm/16W	4,6	BG50WE-840M-D500-U	BG50SE-840M-D500-U	1084,00
500	4000K	On/Off	High	3630lm/28W	4,6	BG50WE-840H-D500-U	BG50SE-840H-D500-U	1084,00
600	4000K	On/Off	Medium	3460lm/25W	6,2	BG50WE-840M-D600-U	BG50SE-840M-D600-U	1309,00
600	4000K	On/Off	High	5620lm/42W	6,2	BG50WE-840H-D600-U	BG50SE-840H-D600-U	1309,00
800	4000K	On/Off	Medium	5280lm/40W	9,5	BG50WE-840M-D800-U	BG50SE-840M-D800-U	2482,00
800	4000K	On/Off	High	7150lm/54W	9,5	BG50WE-840H-D800-U	BG50SE-840H-D800-U	2482,00

Surcharges

Surface Finish	CHF	Control Gear	CHF	CHF	Colour Rendering	CHF	Colour Temperature	CHF	Suspension	CHF
W: Snow White	✓	E: On/Off	✓	✓	8: CRI>80	✓	22: 2200K	+5%	U: Central Suspension	✓
V: Ivory White	✓	L: DALI	+86,00	+172,00	9: CRI>90	+5%	27: 2700K	+5%	P: Tube Suspension [D400-D800]	+86,00
S: Radiant Silver	✓	H: Touch-Dim	+86,00	+172,00	F: Full Spectrum	+15%	30: 3000K	✓	Additional Options CHF	
U: Urban Graphite	✓	C: Casambi*	+261,00	+261,00			35: 3500K	+5%	Radar Sensor	+209,00
B: Jet Black	✓	6: DALI DT6 for TW	+172,00	+343,00			40: 4000K	✓	Multisensor [D400-D800]	+261,00
H: Anodic Champagne	+10%	8: DALI DT8 for TW	+172,00	+343,00			65: 6500K	+5%	Emergency Module [DALI, Autotest, incl. 3H Battery]	+366,00
K: Satin Copper	+15%	*Only in combination with DALI. Please add to dimming price.					TW: Tunable White 2700-6500K* [D400-D800]	+30%		
R: Special RAL/NCS Colours	ⓘ									

✓ standard / no extra charge
ⓘ on request
✗ not available

Basic Déco G3/P3 | Suspended

catalogue page 188



Microprismatic | Direct-Indirect

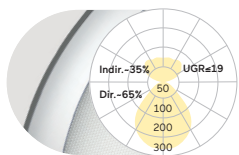

D mm	Colour Temperature	Control	Power	Lumen/Watt	Weight kg	Code Snow White	Code Radiant Silver	CHF
300	4000K	On/Off	Medium	1480lm/13W	2,5	BP3AWE-840M-D300-UW	BP3ASE-840M-D300-US	907,00
300	4000K	On/Off	High	2530lm/23W	2,5	BP3AWE-840H-D300-UW	BP3ASE-840H-D300-US	907,00
400	4000K	On/Off	Medium	2370lm/20W	3,6	BP3AWE-840M-D400-UW	BP3ASE-840M-D400-US	1127,00
400	4000K	On/Off	High	3750lm/31W	3,6	BP3AWE-840H-D400-UW	BP3ASE-840H-D400-US	1127,00
500	4000K	On/Off	Medium	3500lm/29W	5,0	BP3AWE-840M-D500-UW	BP3ASE-840M-D500-US	1355,00
500	4000K	On/Off	High	5810lm/48W	5,0	BP3AWE-840H-D500-UW	BP3ASE-840H-D500-US	1355,00
600	4000K	On/Off	Medium	5380lm/43W	7,3	BP3AWE-840M-D600-UW	BP3ASE-840M-D600-US	1679,00
600	4000K	On/Off	High	7750lm/63W	7,3	BP3AWE-840H-D600-UW	BP3ASE-840H-D600-US	1679,00
800	4000K	On/Off	Medium	7830lm/63W	11,0	BP3AWE-840M-D800-UW	BP3ASE-840M-D800-US	2884,00
800	4000K	On/Off	High	9940lm/82W	11,0	BP3AWE-840H-D800-UW	BP3ASE-840H-D800-US	2884,00

Microprismatic | Direct

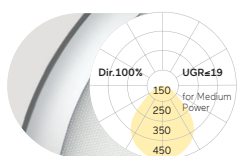

D mm	Colour Temperature	Control	Power	Lumen/Watt	Weight kg	Code Snow White	Code Radiant Silver	CHF
300	4000K	On/Off	Medium	830lm/8W	2,4	BG3AWE-840M-D300-UW	BG3ASE-840M-D300-US	767,00
300	4000K	On/Off	High	1430lm/13W	2,4	BG3AWE-840H-D300-UW	BG3ASE-840H-D300-US	767,00
400	4000K	On/Off	Medium	1500lm/14W	4,7	BG3AWE-840M-D400-UW	BG3ASE-840M-D400-US	970,00
400	4000K	On/Off	High	2410lm/21W	4,7	BG3AWE-840H-D400-UW	BG3ASE-840H-D400-US	970,00
500	4000K	On/Off	Medium	2370lm/21W	5,3	BG3AWE-840M-D500-UW	BG3ASE-840M-D500-US	1180,00
500	4000K	On/Off	High	3980lm/35W	5,3	BG3AWE-840H-D500-UW	BG3ASE-840H-D500-US	1180,00
600	4000K	On/Off	Medium	3560lm/28W	7,0	BG3AWE-840M-D600-UW	BG3ASE-840M-D600-US	1486,00
600	4000K	On/Off	High	5230lm/42W	7,0	BG3AWE-840H-D600-UW	BG3ASE-840H-D600-US	1486,00
800	4000K	On/Off	Medium	5360lm/44W	10,7	BG3AWE-840M-D800-UW	BG3ASE-840M-D800-US	2674,00
800	4000K	On/Off	High	6490lm/55W	10,7	BG3AWE-840H-D800-UW	BG3ASE-840H-D800-US	2674,00

... Basic Déco G3/P3 | Suspended

Opal Diffuser | Direct-Indirect

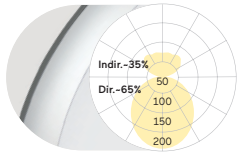

D mm	Colour Temperature	Control	Power	Lumen/Watt	Weight kg	Code Snow White	Code Radiant Silver	CHF
300	4000K	On/Off	Medium	1460lm/13W	2,5	BP3OWE-840M-D300-UW	BP3OSE-840M-D300-US	872,00
300	4000K	On/Off	High	2500lm/23W	2,5	BP3OWE-840H-D300-UW	BP3OSE-840H-D300-US	872,00
400	4000K	On/Off	Medium	2370lm/20W	3,6	BP3OWE-840M-D400-UW	BP3OSE-840M-D400-US	1075,00
400	4000K	On/Off	High	3750lm/31W	3,6	BP3OWE-840H-D400-UW	BP3OSE-840H-D400-US	1075,00
500	4000K	On/Off	Medium	3520lm/29W	5,0	BP3OWE-840M-D500-UW	BP3OSE-840M-D500-US	1285,00
500	4000K	On/Off	High	5870lm/48W	5,0	BP3OWE-840H-D500-UW	BP3OSE-840H-D500-US	1285,00
600	4000K	On/Off	Medium	5470lm/43W	7,3	BP3OWE-840M-D600-UW	BP3OSE-840M-D600-US	1530,00
600	4000K	On/Off	High	7850lm/63W	7,3	BP3OWE-840H-D600-UW	BP3OSE-840H-D600-US	1530,00
800	4000K	On/Off	Medium	7980lm/63W	11,0	BP3OWE-840M-D800-UW	BP3OSE-840M-D800-US	2744,00
800	4000K	On/Off	High	10110lm/82W	11,0	BP3OWE-840H-D800-UW	BP3OSE-840H-D800-US	2744,00

Opal Diffuser | Direct

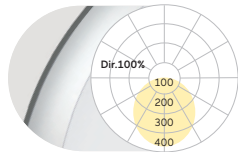

D mm	Colour Temperature	Control	Power	Lumen/Watt	Weight kg	Code Snow White	Code Radiant Silver	CHF
300	4000K	On/Off	Medium	810lm/8W	2,4	BG3OWE-840M-D300-UW	BG3OSE-840M-D300-US	732,00
300	4000K	On/Off	High	1400lm/13W	2,4	BG3OWE-840H-D300-UW	BG3OSE-840H-D300-US	732,00
400	4000K	On/Off	Medium	1500lm/14W	4,7	BG3OWE-840M-D400-UW	BG3OSE-840M-D400-US	917,00
400	4000K	On/Off	High	2410lm/21W	4,7	BG3OWE-840H-D400-UW	BG3OSE-840H-D400-US	917,00
500	4000K	On/Off	Medium	2390lm/21W	5,3	BG3OWE-840M-D500-UW	BG3OSE-840M-D500-US	1110,00
500	4000K	On/Off	High	4040lm/35W	5,3	BG3OWE-840H-D500-UW	BG3OSE-840H-D500-US	1110,00
600	4000K	On/Off	Medium	3650lm/28W	7,0	BG3OWE-840M-D600-UW	BG3OSE-840M-D600-US	1337,00
600	4000K	On/Off	High	5330lm/42W	7,0	BG3OWE-840H-D600-UW	BG3OSE-840H-D600-US	1337,00
800	4000K	On/Off	Medium	5510lm/44W	10,7	BG3OWE-840M-D800-UW	BG3OSE-840M-D800-US	2534,00
800	4000K	On/Off	High	6660lm/55W	10,7	BG3OWE-840H-D800-UW	BG3OSE-840H-D800-US	2534,00

Surcharges

Surface / Reflector Finish

Uni-Colours	CHF
W...W: Snow White / Snow White	✓
V...V: Ivory White / Ivory White	✓
S...S: Radiant Silver / Radiant Silver	✓
U...U: Urban Graphite / Urban Graphite	✓
B...B: Jet Black / Jet Black	✓
H...H: Anodic Champ. / Anodic Champ.	+5%
K...K: Satin Copper / Satin Copper	+15%

Surface / Reflector Finish

Dual Colours	CHF
W...G: Snow White / Satin Gold	+15%
W...K: Snow White / Satin Copper	+15%
W...B: Snow White / Jet Black	+15%
H...B: Anodic Champ./ Jet Black	+15%
B...G: Jet Black / Satin Gold	+15%
B...W: Jet Black / Snow White	+15%

Control Gear	CHF	CHF
	D300-D600	D800
E: On/Off	✓	✓
L: DALI	+86,00	+172,00
H: Touch-Dim	+86,00	+172,00
C: Casambi*	+261,00	+261,00
6: DALI DT6 for TW	+172,00	+343,00
8: DALI DT8 for TW	+172,00	+343,00

*Only in combination with DALI. Please add to dimming price.

Colour Rendering	CHF
8: CRI>80	✓
9: CRI>90	+5%
F: Full Spectrum	+15%

Colour Temperature

CHF	
22: 2200K	+5%
27: 2700K	+5%
30: 3000K	✓
35: 3500K	+5%
40: 4000K	✓
65: 6500K	+5%
TW: Tunable White 2700-6500K* [D400-D800]	+30%

*Only in combination with DT6, DT8 or Casambi control. Please add additional control price.

Suspension

CHF	
U: Central Suspension	✓
P: Tube Suspension[D400-D800]	+86,00

Additional Options

CHF	
Radars Sensor	+209,00
Multisensor [D400-D800]	+261,00
Emergency Module [DALI, Autotest, incl. 3H Battery] [D400-D800]	+366,00

✓ standard / no extra charge ⚡ on request ✗ not available

Basic Déco XXL G4/P4 | Suspended

catalogue page 190



Tube Suspension

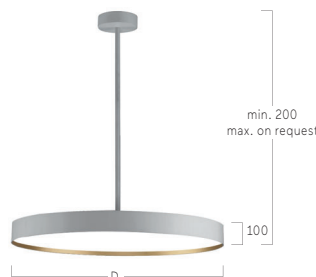

Central Suspension



Parallel Suspension



Microprismatic | Direct-Indirect

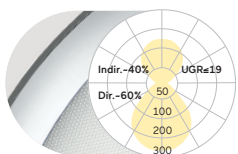

D mm	Colour Temperature	Control	Power	Lumen/Watt	Weight kg	Code Snow White	Code Radiant Silver	CHF
300	4000K	On/Off	Low	1440lm/12W	3,5	BP4AWE-840E-D300-UW	BP4ASE-840E-D300-US	924,00
300	4000K	On/Off	Medium	2810lm/21W	3,5	BP4AWE-840M-D300-UW	BP4ASE-840M-D300-US	924,00
400	4000K	On/Off	Low	2800lm/19W	4,5	BP4AWE-840E-D400-UW	BP4ASE-840E-D400-US	1162,00
400	4000K	On/Off	Medium	5740lm/40W	4,5	BP4AWE-840M-D400-UW	BP4ASE-840M-D400-US	1162,00
500	4000K	On/Off	Low	3970lm/29W	6,5	BP4AWE-840E-D500-UW	BP4ASE-840E-D500-US	1407,00
500	4000K	On/Off	Medium	7760lm/53W	6,5	BP4AWE-840M-D500-UW	BP4ASE-840M-D500-US	1407,00
600	4000K	On/Off	Low	8370lm/55W	10,0	BP4AWE-840E-D600-UW	BP4ASE-840E-D600-US	1749,00
600	4000K	On/Off	Medium	12900lm/87W	10,0	BP4AWE-840M-D600-UW	BP4ASE-840M-D600-US	1749,00
900	4000K	On/Off	Low	11330lm/88W	15,0	BP4AWE-840E-D900-UW	BP4ASE-840E-D900-US	2972,00
900	4000K	On/Off	Medium	17110lm/144W	15,0	BP4AWE-840M-D900-UW	BP4ASE-840M-D900-US	2972,00
1200	4000K	On/Off	Low	18140lm/143W	24,0	BP4AWE-840E-D1200-UW	BP4ASE-840E-D1200-US	4109,00
1200	4000K	On/Off	Medium	28870lm/251W	24,0	BP4AWE-840M-D1200-UW	BP4ASE-840M-D1200-US	4109,00

Microprismatic | Direct

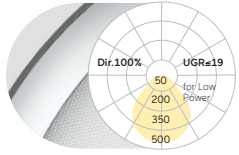

D mm	Colour Temperature	Control	Power	Lumen/Watt	Weight kg	Code Snow White	Code Radiant Silver	CHF
300	4000K	On/Off	Low	880lm/8W	3,5	BG4AWE-840E-D300-UW	BG4ASE-840E-D300-US	784,00
300	4000K	On/Off	Medium	1730lm/14W	3,5	BG4AWE-840M-D300-UW	BG4ASE-840M-D300-US	784,00
400	4000K	On/Off	Low	1740lm/13W	4,5	BG4AWE-840E-D400-UW	BG4ASE-840E-D400-US	1005,00
400	4000K	On/Off	Medium	3580lm/29W	4,5	BG4AWE-840M-D400-UW	BG4ASE-840M-D400-US	1005,00
500	4000K	On/Off	Low	2480lm/18W	6,5	BG4AWE-840E-D500-UW	BG4ASE-840E-D500-US	1232,00
500	4000K	On/Off	Medium	4860lm/35W	6,5	BG4AWE-840M-D500-UW	BG4ASE-840M-D500-US	1232,00
600	4000K	On/Off	Low	3860lm/28W	10,0	BG4AWE-840E-D600-UW	BG4ASE-840E-D600-US	1556,00
600	4000K	On/Off	Medium	7250lm/52W	10,0	BG4AWE-840M-D600-UW	BG4ASE-840M-D600-US	1556,00
900	4000K	On/Off	Low	6800lm/59W	15,0	BG4AWE-840E-D900-UW	BG4ASE-840E-D900-US	2762,00
900	4000K	On/Off	Medium	11490lm/106W	15,0	BG4AWE-840M-D900-UW	BG4ASE-840M-D900-US	2762,00
1200	4000K	On/Off	Low	11890lm/107W	24,0	BG4AWE-840E-D1200-UW	BG4ASE-840E-D1200-US	3759,00
1200	4000K	On/Off	Medium	20110lm/195W	24,0	BG4AWE-840M-D1200-UW	BG4ASE-840M-D1200-US	3759,00

Opal Diffuser | Direct-Indirect

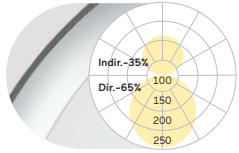

D mm	Colour Temperature	Control	Power	Lumen/Watt	Weight kg	Code Snow White	Code Radiant Silver	CHF
300	4000K	On/Off	Low	1470lm/12W	3,5	BP4OWE-840E-D300-UW	BP4OSE-840E-D300-US	889,00
300	4000K	On/Off	Medium	2860lm/21W	3,5	BP4OWE-840M-D300-UW	BP4OSE-840M-D300-US	889,00
400	4000K	On/Off	Low	2850lm/19W	4,5	BP4OWE-840E-D400-UW	BP4OSE-840E-D400-US	1110,00
400	4000K	On/Off	Medium	5850lm/40W	4,5	BP4OWE-840M-D400-UW	BP4OSE-840M-D400-US	1110,00
500	4000K	On/Off	Low	4040lm/29W	6,5	BP4OWE-840E-D500-UW	BP4OSE-840E-D500-US	1337,00
500	4000K	On/Off	Medium	7910lm/53W	6,5	BP4OWE-840M-D500-UW	BP4OSE-840M-D500-US	1337,00
600	4000K	On/Off	Low	8490lm/55W	10,0	BP4OWE-840E-D600-UW	BP4OSE-840E-D600-US	1600,00
600	4000K	On/Off	Medium	13120lm/87W	10,0	BP4OWE-840M-D600-UW	BP4OSE-840M-D600-US	1600,00
900	4000K	On/Off	Low	11530lm/88W	15,0	BP4OWE-840E-D900-UW	BP4OSE-840E-D900-US	2832,00
900	4000K	On/Off	Medium	17450lm/144W	15,0	BP4OWE-840M-D900-UW	BP4OSE-840M-D900-US	2832,00
1200	4000K	On/Off	Low	18500lm/143W	24,0	BP4OWE-840E-D1200-UW	BP4OSE-840E-D1200-US	3927,00
1200	4000K	On/Off	Medium	29460lm/251W	24,0	BP4OWE-840M-D1200-UW	BP4OSE-840M-D1200-US	3927,00
1500	4000K	On/Off	Low	20850lm/181W	35,5	BP4OWE-840E-D1500-UW	BP4OSE-840E-D1500-US	5679,00
1500	4000K	On/Off	Medium	34360lm/324W	35,5	BP4OWE-840M-D1500-UW	BP4OSE-840M-D1500-US	5679,00

Opal Diffuser | Direct

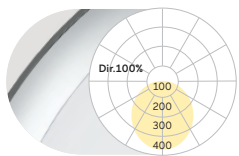

D mm	Colour Temperature	Control	Power	Lumen/Watt	Weight kg	Code Snow White	Code Radiant Silver	CHF
300	4000K	On/Off	Low	910lm/8W	3,5	BG4OWE-840E-D300-UW	BG4OSE-840E-D300-US	749,00
300	4000K	On/Off	Medium	1780lm/14W	3,5	BG4OWE-840M-D300-UW	BG4OSE-840M-D300-US	749,00
400	4000K	On/Off	Low	1790lm/13W	4,5	BG4OWE-840E-D400-UW	BG4OSE-840E-D400-US	952,00
400	4000K	On/Off	Medium	3690lm/29W	4,5	BG4OWE-840M-D400-UW	BG4OSE-840M-D400-US	952,00
500	4000K	On/Off	Low	2550lm/18W	6,5	BG4OWE-840E-D500-UW	BG4OSE-840E-D500-US	1162,00
500	4000K	On/Off	Medium	5010lm/35W	6,5	BG4OWE-840M-D500-UW	BG4OSE-840M-D500-US	1162,00
600	4000K	On/Off	Low	3980lm/28W	10,0	BG4OWE-840E-D600-UW	BG4OSE-840E-D600-US	1407,00
600	4000K	On/Off	Medium	7470lm/52W	10,0	BG4OWE-840M-D600-UW	BG4OSE-840M-D600-US	1407,00
900	4000K	On/Off	Low	7000lm/59W	15,0	BG4OWE-840E-D900-UW	BG4OSE-840E-D900-US	2622,00
900	4000K	On/Off	Medium	11830lm/106W	15,0	BG4OWE-840M-D900-UW	BG4OSE-840M-D900-US	2622,00
1200	4000K	On/Off	Low	12250lm/107W	24,0	BG4OWE-840E-D1200-UW	BG4OSE-840E-D1200-US	3577,00
1200	4000K	On/Off	Medium	20700lm/195W	24,0	BG4OWE-840M-D1200-UW	BG4OSE-840M-D1200-US	3577,00
1500	4000K	On/Off	Low	17290lm/162W	36,0	BG4OWE-840E-D1500-UW	BG4OSE-840E-D1500-US	5242,00
1500	4000K	On/Off	Medium	28950lm/287W	36,0	BG4OWE-840M-D1500-UW	BG4OSE-840M-D1500-US	5242,00

Surcharges

Surface / Reflector Finish

Surface / Reflector Finish	CHF
Uni-Colours	
W...W: Snow White / Snow White	✓
V...V: Ivory White / Ivory White	✓
S...S: Radiant Silver / Radiant Silver	✓
U...U: Urban Graphite / Urban Graphite	✓
B...B: Jet Black / Jet Black	✓
H...H: Anodic Champ. / Anodic Champ.	+5%
K...K: Satin Copper / Satin Copper	+15%
Dual Colours	
W...G: Snow White / Satin Gold	+15%
W...K: Snow White / Satin Copper	+15%
W...B: Snow White / Jet Black	+15%
H...B: Anodic Champ./ Jet Black	+15%
B...G: Jet Black / Satin Gold	+15%
B...W: Jet Black / Snow White	+15%

Control Gear

Control Gear	CHF D300-D600	CHF D900-D1200	CHF D1500
E: On/Off	✓	✓	✓
L: DALI	+86,00	+172,00	+258,00
H: Touch-Dim	+86,00	+172,00	+258,00
C: Casambi*	+261,00	+261,00	+261,00
6: DALI DT6 for TW	+172,00	+343,00	+515,00
8: DALI DT8 for TW	+172,00	+343,00	+515,00

*Only in combination with DALI. Please add to dimming price.

Colour Rendering

Colour Rendering	CHF
8: CRI>80	✓
9: CRI>90	+5%
F: Full Spectrum	+15%

Colour Temperature

Colour Temperature	CHF
22: 2200K	+5%
27: 2700K	+5%
30: 3000K	✓
35: 3500K	+5%
40: 4000K	✓
65: 6500K	+5%
TW: Tunable White 2700-6500K* [D400-D800]	+30%

*Only in combination with T6, DT8 or Casambi control. Please add additional control price.

Suspension

Suspension	CHF
U: Central Suspension	✓
K: Parallel Suspension	✓
P: Tube Suspension [D400-D900]	+86,00

Additional Options

Additional Options	CHF
Radar Sensor	+209,00
Multisensor [D400-D1500]	+261,00
Emergency Module [DALI, Autotest, incl. 3H Battery] [D400-D1500]	+366,00

✓ standard / no extra charge ⚠ on request ✗ not available

Basic Déco O3 | Suspended

catalogue page 192



Microprismatic | Direct

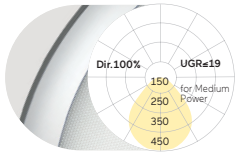

D mm	Colour Temperature	Control	Power	Lumen/Watt	Weight kg	Code Snow White	Code Radiant Silver	CHF
300	4000K	On/Off	Medium	830lm/8W	3,0	BO3AWE-840M-D300-PW	BO3ASE-840M-D300-PS	812,00
300	4000K	On/Off	High	1430lm/13W	3,0	BO3AWE-840H-D300-PW	BO3ASE-840H-D300-PS	812,00
400	4000K	On/Off	Medium	1500lm/14W	4,1	BO3AWE-840M-D400-PW	BO3ASE-840M-D400-PS	1015,00
400	4000K	On/Off	High	2410lm/21W	4,1	BO3AWE-840H-D400-PW	BO3ASE-840H-D400-PS	1015,00
500	4000K	On/Off	Medium	2370lm/21W	6,0	BO3AWE-840M-D500-PW	BO3ASE-840M-D500-PS	1225,00
500	4000K	On/Off	High	3980lm/35W	6,0	BO3AWE-840H-D500-PW	BO3ASE-840H-D500-PS	1225,00
600	4000K	On/Off	Medium	3560lm/28W	7,8	BO3AWE-840M-D600-PW	BO3ASE-840M-D600-PS	1532,00
600	4000K	On/Off	High	5230lm/42W	7,8	BO3AWE-840H-D600-PW	BO3ASE-840H-D600-PS	1532,00

Opal Diffuser | Direct

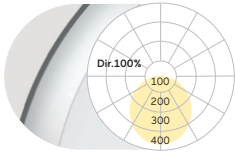

D mm	Colour Temperature	Control	Power	Lumen/Watt	Weight kg	Code Snow White	Code Radiant Silver	CHF
300	4000K	On/Off	Medium	810lm/8W	3,0	BO3OWE-840M-D300-PW	BO3OSE-840M-D300-PS	777,00
300	4000K	On/Off	High	1400lm/13W	3,0	BO3OWE-840H-D300-PW	BO3OSE-840H-D300-PS	777,00
400	4000K	On/Off	Medium	1500lm/14W	4,1	BO3OWE-840M-D400-PW	BO3OSE-840M-D400-PS	963,00
400	4000K	On/Off	High	2410lm/21W	4,1	BO3OWE-840H-D400-PW	BO3OSE-840H-D400-PS	963,00
500	4000K	On/Off	Medium	2390lm/21W	6,0	BO3OWE-840M-D500-PW	BO3OSE-840M-D500-PS	1155,00
500	4000K	On/Off	High	4040lm/35W	6,0	BO3OWE-840H-D500-PW	BO3OSE-840H-D500-PS	1155,00
600	4000K	On/Off	Medium	3650lm/28W	7,8	BO3OWE-840M-D600-PW	BO3OSE-840M-D600-PS	1383,00
600	4000K	On/Off	High	5330lm/42W	7,8	BO3OWE-840H-D600-PW	BO3OSE-840H-D600-PS	1383,00

Surcharges

Surface / Reflector Finish

Uni-Colours

Code	Finish	CHF
W...W:	Snow White / Snow White	✓
V...V:	Ivory White / Ivory White	✓
S...S:	Radiant Silver / Radiant Silver	✓
U...U:	Urban Graphite / Urban Graphite	✓
B...B:	Jet Black / Jet Black	✓
H...H:	Anodic Champ. / Anodic Champ.	+5%
K...K:	Satin Copper / Satin Copper	+15%

Surface / Reflector Finish

Dual Colours

Code	Finish	CHF
W...G:	Snow White / Satin Gold	+15%
W...K:	Snow White / Satin Copper	+15%
W...B:	Snow White / Jet Black	+15%
H...B:	Anodic Champ. / Jet Black	+15%
B...G:	Jet Black / Satin Gold	+15%
B...W:	Jet Black / Snow White	+15%

Control Gear

Code	Control	CHF
E:	On/Off	✓
L:	DALI	+86,00
H:	Touch-Dim	+86,00
C:	Casambi*[D400-D600]	+261,00
6:	DALI DT6 for TW	+172,00
8:	DALI DT8 for TW	+172,00

*Only in combination with DALI.
Please add to dimming price.

Colour Rendering

Code	CR	CHF
8:	CRi>80	✓
9:	CRi>90	+5%
F:	Full Spectrum	+15%

Colour Temperature

Code	Temp	CHF
22:	2200K	+5%
27:	2700K	+5%
30:	3000K	✓
35:	3500K	+5%
40:	4000K	✓
65:	6500K	+5%
TW:	Tunable White 2700-6500K*[D400-D600]	+30%

*Only in combination with DT6, DT8 or Casambi control. Please add additional control price.

✓ standard / no extra charge ⚠ on request ✗ not available

Basic Max G1/P1 | Suspended

catalogue page 196

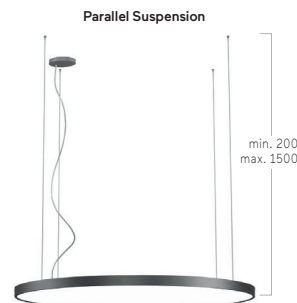
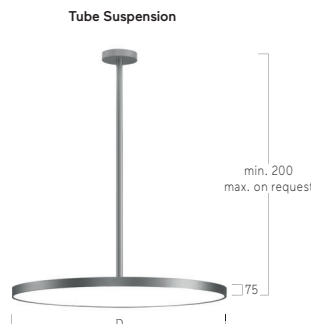

Microprismatic | Direct-Indirect

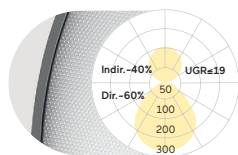

D mm	Colour Temperature	Control	Power	Lumen/Watt	Weight kg	Code Snow White	Code Radiant Silver	CHF
300	4000K	On/Off	Low	1440lm/12W	2,9	BP1AWE-840E-D300-U	BP1ASE-840E-D300-U	681,00
300	4000K	On/Off	Medium	2810lm/21W	2,9	BP1AWE-840M-D300-U	BP1ASE-840M-D300-U	681,00
400	4000K	On/Off	Low	2800lm/19W	4,3	BP1AWE-840E-D400-U	BP1ASE-840E-D400-U	874,00
400	4000K	On/Off	Medium	5740lm/40W	4,3	BP1AWE-840M-D400-U	BP1ASE-840M-D400-U	874,00
500	4000K	On/Off	Low	3970lm/29W	6,7	BP1AWE-840E-D500-U	BP1ASE-840E-D500-U	1152,00
500	4000K	On/Off	Medium	7760lm/53W	6,7	BP1AWE-840M-D500-U	BP1ASE-840M-D500-U	1152,00
600	4000K	On/Off	Low	8370lm/55W	10,1	BP1AWE-840E-D600-U	BP1ASE-840E-D600-U	1369,00
600	4000K	On/Off	Medium	12900lm/87W	10,1	BP1AWE-840M-D600-U	BP1ASE-840M-D600-U	1369,00
900	4000K	On/Off	Low	11330lm/88W	13,1	BP1AWE-840E-D900-U	BP1ASE-840E-D900-U	2468,00
900	4000K	On/Off	Medium	17110lm/144W	13,1	BP1AWE-840M-D900-U	BP1ASE-840M-D900-U	2468,00
1200	4000K	On/Off	Low	18140lm/143W	22,0	BP1AWE-840E-D1200-U	BP1ASE-840E-D1200-U	4118,00
1200	4000K	On/Off	Medium	28870lm/251W	22,0	BP1AWE-840M-D1200-U	BP1ASE-840M-D1200-U	4118,00

Microprismatic | Direct

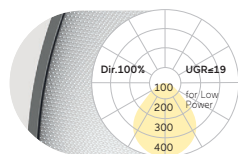

D mm	Colour Temperature	Control	Power	Lumen/Watt	Weight kg	Code Snow White	Code Radiant Silver	CHF
300	4000K	On/Off	Low	880lm/8W	2,5	BG1AWE-840E-D300-U	BG1ASE-840E-D300-U	636,00
300	4000K	On/Off	Medium	1730lm/14W	2,5	BG1AWE-840M-D300-U	BG1ASE-840M-D300-U	636,00
400	4000K	On/Off	Low	1740lm/13W	3,9	BG1AWE-840E-D400-U	BG1ASE-840E-D400-U	868,00
400	4000K	On/Off	Medium	3580lm/29W	3,9	BG1AWE-840M-D400-U	BG1ASE-840M-D400-U	868,00
500	4000K	On/Off	Low	2480lm/18W	6,1	BG1AWE-840E-D500-U	BG1ASE-840E-D500-U	1050,00
500	4000K	On/Off	Medium	4860lm/35W	6,1	BG1AWE-840M-D500-U	BG1ASE-840M-D500-U	1050,00
600	4000K	On/Off	Low	3860lm/28W	9,3	BG1AWE-840E-D600-U	BG1ASE-840E-D600-U	1355,00
600	4000K	On/Off	Medium	7250lm/52W	9,3	BG1AWE-840M-D600-U	BG1ASE-840M-D600-U	1355,00
900	4000K	On/Off	Low	6800lm/59W	12,6	BG1AWE-840E-D900-U	BG1ASE-840E-D900-U	2414,00
900	4000K	On/Off	Medium	11490lm/106W	12,6	BG1AWE-840M-D900-U	BG1ASE-840M-D900-U	2414,00
1200	4000K	On/Off	Low	11890lm/107W	21,0	BG1AWE-840E-D1200-U	BG1ASE-840E-D1200-U	3843,00
1200	4000K	On/Off	Medium	20110lm/195W	21,0	BG1AWE-840M-D1200-U	BG1ASE-840M-D1200-U	3843,00

Opal Diffuser | Direct-Indirect

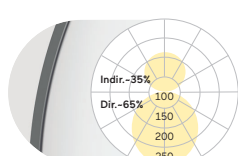

D mm	Colour Temperature	Control	Power	Lumen/Watt	Weight kg	Code Snow White	Code Radiant Silver	CHF
300	4000K	On/Off	Low	1470lm/12W	2,9	BP1OWE-840E-D300-U	BP1OSE-840E-D300-U	648,00
300	4000K	On/Off	Medium	2860lm/21W	2,9	BP1OWE-840M-D300-U	BP1OSE-840M-D300-U	648,00
400	4000K	On/Off	Low	2850lm/19W	4,3	BP1OWE-840E-D400-U	BP1OSE-840E-D400-U	809,00
400	4000K	On/Off	Medium	5850lm/40W	4,3	BP1OWE-840M-D400-U	BP1OSE-840M-D400-U	809,00
500	4000K	On/Off	Low	4040lm/29W	6,7	BP1OWE-840E-D500-U	BP1OSE-840E-D500-U	1045,00
500	4000K	On/Off	Medium	7910lm/53W	6,7	BP1OWE-840M-D500-U	BP1OSE-840M-D500-U	1045,00
600	4000K	On/Off	Low	8490lm/55W	10,1	BP1OWE-840E-D600-U	BP1OSE-840E-D600-U	1285,00
600	4000K	On/Off	Medium	13120lm/87W	10,1	BP1OWE-840M-D600-U	BP1OSE-840M-D600-U	1285,00
900	4000K	On/Off	Low	11530lm/88W	13,1	BP1OWE-840E-D900-U	BP1OSE-840E-D900-U	2331,00
900	4000K	On/Off	Medium	17450lm/144W	13,1	BP1OWE-840M-D900-U	BP1OSE-840M-D900-U	2331,00
1200	4000K	On/Off	Low	18500lm/143W	22,0	BP1OWE-840E-D1200-U	BP1OSE-840E-D1200-U	3931,00
1200	4000K	On/Off	Medium	29460lm/251W	22,0	BP1OWE-840M-D1200-U	BP1OSE-840M-D1200-U	3931,00
1500	4000K	On/Off	Low	20850lm/181W	30,0	BP1TWE-840E-D1500-U	BP1TSE-840E-D1500-U	5767,00
1500	4000K	On/Off	Medium	34360lm/324W	30,0	BP1TWE-840M-D1500-U	BP1TSE-840M-D1500-U	5767,00
2000	4000K	On/Off	Low	35880lm/315W	52,0	BP1TWE-840E-D2000-K	BP1TSE-840E-D2000-K	9536,00
2000	4000K	On/Off	Medium	59120lm/578W	52,0	BP1TWE-840M-D2000-K	BP1TSE-840M-D2000-K	9536,00

Opal Diffuser | Direct

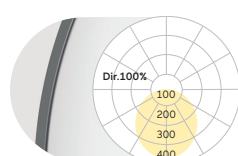

D mm	Colour Temperature	Control	Power	Lumen/Watt	Weight kg	Code Snow White	Code Radiant Silver	CHF
300	4000K	On/Off	Low	910lm/8W	2,5	BG1OWE-840E-D300-U	BG1OSE-840E-D300-U	562,00
300	4000K	On/Off	Medium	1780lm/14W	2,5	BG1OWE-840M-D300-U	BG1OSE-840M-D300-U	562,00
400	4000K	On/Off	Low	1790lm/13W	3,9	BG1OWE-840E-D400-U	BG1OSE-840E-D400-U	772,00
400	4000K	On/Off	Medium	3690lm/29W	3,9	BG1OWE-840M-D400-U	BG1OSE-840M-D400-U	772,00
500	4000K	On/Off	Low	2550lm/18W	6,1	BG1OWE-840E-D500-U	BG1OSE-840E-D500-U	917,00
500	4000K	On/Off	Medium	5010lm/35W	6,1	BG1OWE-840M-D500-U	BG1OSE-840M-D500-U	917,00
600	4000K	On/Off	Low	3980lm/28W	9,3	BG1OWE-840E-D600-U	BG1OSE-840E-D600-U	1208,00
600	4000K	On/Off	Medium	7470lm/52W	9,3	BG1OWE-840M-D600-U	BG1OSE-840M-D600-U	1208,00
900	4000K	On/Off	Low	7000lm/59W	12,6	BG1OWE-840E-D900-U	BG1OSE-840E-D900-U	2237,00
900	4000K	On/Off	Medium	11830lm/106W	12,6	BG1OWE-840M-D900-U	BG1OSE-840M-D900-U	2237,00
1200	4000K	On/Off	Low	12250lm/107W	21,0	BG1OWE-840E-D1200-U	BG1OSE-840E-D1200-U	3649,00
1200	4000K	On/Off	Medium	20700lm/195W	21,0	BG1OWE-840M-D1200-U	BG1OSE-840M-D1200-U	3649,00
1500	4000K	On/Off	Low	17290lm/162W	30,0	BG1TWE-840E-D1500-U	BG1TSE-840E-D1500-U	5406,00
1500	4000K	On/Off	Medium	28950lm/287W	30,0	BG1TWE-840M-D1500-U	BG1TSE-840M-D1500-U	5406,00
2000	4000K	On/Off	Low	29860lm/284W	52,0	BG1TWE-840E-D2000-K	BG1TSE-840E-D2000-K	8995,00
2000	4000K	On/Off	Medium	50000lm/526W	52,0	BG1TWE-840M-D2000-K	BG1TSE-840M-D2000-K	8995,00

Surcharges

Surface Finish	CHF	Control Gear	CHF	CHF	CHF	Colour Temperature	CHF	Suspension	CHF
W: Snow White	✓	E: On/Off	✓	✓	✓	22: 2200K	+5%	U: Central Suspension [D300-D1500]	✓
V: Ivory White	✓	L: DALI	+86,00	+172,00	+258,00	27: 2700K	+5%	K: Parallel Suspension	✓
S: Radiant Silver	✓	H: Touch-Dim	+86,00	+172,00	+258,00	30: 3000K	✓	P: Tube Suspension [D400-D900]	+86,00
U: Urban Graphite	✓	C: Casambi*	+261,00	+261,00	+261,00	35: 3500K	+5%		
B: Jet Black	✓	6: DALI DT6 for TW	+172,00	+343,00	+686,00	40: 4000K	✓		
H: Anodic Champagne	+10%	8: DALI DT8 for TW	+172,00	+343,00	+686,00	65: 6500K	+5%		
K: Satin Copper	+15%					TW: Tunable White 2700-6500K* [D400-D1200]	+30%	Additional Options	CHF
R: Special RAL/NCS Colours	🔴							Radar Sensor	+209,00
		*Only in combination with DALI. Please add to dimming price.						Multisensor [D400-D1500]	+261,00
		Colour Rendering	CHF					Emergency Module [DALI, Autotest, incl. 3H Battery] [D400-D1500]	+366,00
		8: CRI>80	✓						
		9: CRI>90	+5%						
		F: Full Spectrum	+15%						

✓ standard / no extra charge 🔴 on request 🚫 not available

Basic Visio G9/P9 | Suspended

catalogue page 198

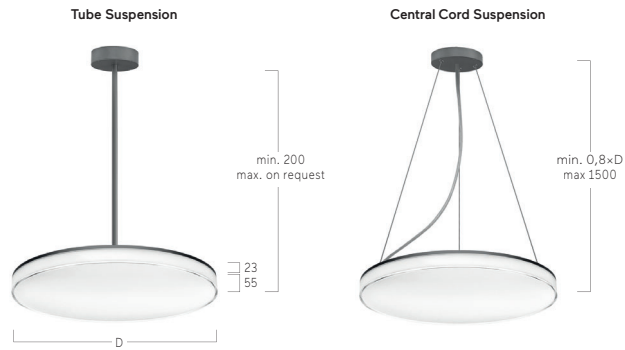

Microprismatic | Direct-Indirect

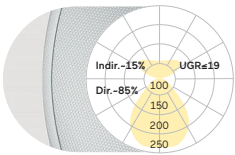

D mm	Colour Temperature	Control	Power	Lumen/Watt	Weight kg	Code Snow White	Code Urban Graphite	CHF
300	4000K	On/Off	Medium	760lm/6W	3,6	BP9AWE-840M-D300-U	BP9AUE-840M-D300-U	856,00
300	4000K	On/Off	High	1200lm/10W	3,6	BP9AWE-840H-D300-U	BP9AUE-840H-D300-U	856,00
400	4000K	On/Off	Medium	1770lm/14W	4,8	BP9AWE-840M-D400-U	BP9AUE-840M-D400-U	1066,00
400	4000K	On/Off	High	3090lm/23W	4,8	BP9AWE-840H-D400-U	BP9AUE-840H-D400-U	1066,00
500	4000K	On/Off	Medium	2840lm/21W	6,0	BP9AWE-840M-D500-U	BP9AUE-840M-D500-U	1364,00
500	4000K	On/Off	High	5230lm/38W	6,0	BP9AWE-840H-D500-U	BP9AUE-840H-D500-U	1364,00
610	4000K	On/Off	Medium	3830lm/28W	7,1	BP9AWE-840M-D610-U	BP9AUE-840M-D610-U	1871,00
610	4000K	On/Off	High	7100lm/52W	7,1	BP9AWE-840H-D610-U	BP9AUE-840H-D610-U	1871,00

Microprismatic | Direct

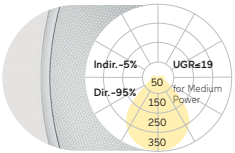

D mm	Colour Temperature	Control	Power	Lumen/Watt	Weight kg	Code Snow White	Code Urban Graphite	CHF
300	4000K	On/Off	Medium	630lm/5W	3,4	BG9AWE-840M-D300-U	BG9AUE-840M-D300-U	769,00
300	4000K	On/Off	High	1000lm/9W	3,4	BG9AWE-840H-D300-U	BG9AUE-840H-D300-U	769,00
400	4000K	On/Off	Medium	1630lm/13W	4,4	BG9AWE-840M-D400-U	BG9AUE-840M-D400-U	961,00
400	4000K	On/Off	High	2840lm/22W	4,4	BG9AWE-840H-D400-U	BG9AUE-840H-D400-U	961,00
500	4000K	On/Off	Medium	2470lm/19W	5,5	BG9AWE-840M-D500-U	BG9AUE-840M-D500-U	1206,00
500	4000K	On/Off	High	4560lm/34W	5,5	BG9AWE-840H-D500-U	BG9AUE-840H-D500-U	1206,00
610	4000K	On/Off	Medium	3340lm/25W	6,7	BG9AWE-840M-D610-U	BG9AUE-840M-D610-U	1644,00
610	4000K	On/Off	High	6200lm/46W	6,7	BG9AWE-840H-D610-U	BG9AUE-840H-D610-U	1644,00

Opal Diffuser | Direct-Indirect

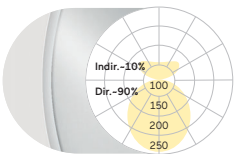

D mm	Colour Temperature	Control	Power	Lumen/Watt	Weight kg	Code Snow White	Code Urban Graphite	CHF
300	4000K	On/Off	Medium	800lm/6W	3,6	BP9OWE-840M-D300-U	BP9OUE-840M-D300-U	769,00
300	4000K	On/Off	High	1260lm/10W	3,6	BP9OWE-840H-D300-U	BP9OUE-840H-D300-U	769,00
400	4000K	On/Off	Medium	1870lm/14W	4,8	BP9OWE-840M-D400-U	BP9OUE-840M-D400-U	961,00
400	4000K	On/Off	High	3270lm/23W	4,8	BP9OWE-840H-D400-U	BP9OUE-840H-D400-U	961,00
500	4000K	On/Off	Medium	2990lm/21W	6,0	BP9OWE-840M-D500-U	BP9OUE-840M-D500-U	1224,00
500	4000K	On/Off	High	5500lm/38W	6,0	BP9OWE-840H-D500-U	BP9OUE-840H-D500-U	1224,00
610	4000K	On/Off	Medium	4040lm/28W	7,1	BP9OWE-840M-D610-U	BP9OUE-840M-D610-U	1609,00
610	4000K	On/Off	High	7470lm/52W	7,1	BP9OWE-840H-D610-U	BP9OUE-840H-D610-U	1609,00

Opal Diffuser | Direct

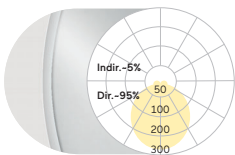

D mm	Colour Temperature	Control	Power	Lumen/Watt	Weight kg	Code Snow White	Code Urban Graphite	CHF
300	4000K	On/Off	Medium	670lm/5W	3,4	BG9OWE-840M-D300-U	BG9OUE-840M-D300-U	681,00
300	4000K	On/Off	High	1060lm/9W	3,4	BG9OWE-840H-D300-U	BG9OUE-840H-D300-U	681,00
400	4000K	On/Off	Medium	1730lm/13W	4,4	BG9OWE-840M-D400-U	BG9OUE-840M-D400-U	856,00
400	4000K	On/Off	High	3020lm/22W	4,4	BG9OWE-840H-D400-U	BG9OUE-840H-D400-U	856,00
500	4000K	On/Off	Medium	2620lm/19W	5,5	BG9OWE-840M-D500-U	BG9OUE-840M-D500-U	1066,00
500	4000K	On/Off	High	4830lm/34W	5,5	BG9OWE-840H-D500-U	BG9OUE-840H-D500-U	1066,00
610	4000K	On/Off	Medium	3550lm/25W	6,7	BG9OWE-840M-D610-U	BG9OUE-840M-D610-U	1381,00
610	4000K	On/Off	High	6570lm/46W	6,7	BG9OWE-840H-D610-U	BG9OUE-840H-D610-U	1381,00

Surcharges

Surface Finish	CHF	Control Gear	CHF	Colour Rendering	CHF	Colour Temperature	CHF	Suspension	CHF
W: Snow White	✓	E: On/Off	✓	8: CRI>80	✓	22: 2200K	+5%	U: Central Suspension	✓
U: Urban Graphite	✓	L: DALI	+86,00	9: CRI>90	+5%	27: 2700K	+5%	P: Tube Suspension [D400-D610]	+86,00
R: Special RAL/NCS Colours	⚡	H: Touch-Dim	+86,00	F: Full Spectrum	+15%	30: 3000K	✓		
		C: Casambi*	+261,00			35: 3500K	+5%		
						40: 4000K	✓		
						65: 6500K	+5%		

*Only in combination with DALI. Please add to dimming price.

✓ standard / no extra charge ⚡ on request ✗ not available

Beam Me Up (Flat) G3/P3 | Suspended

catalogue page 202

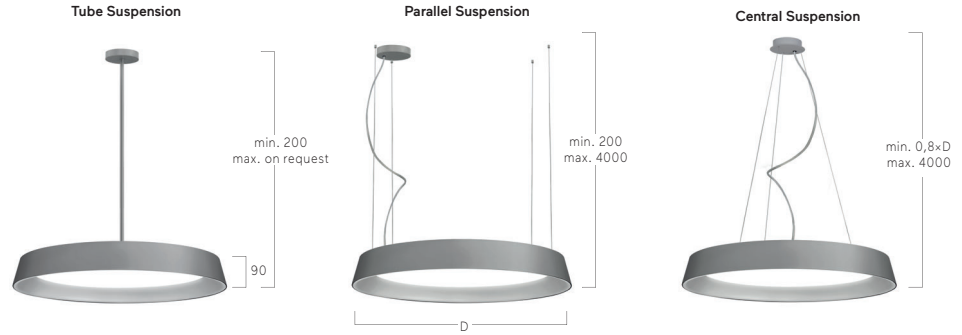

Microprismatic | Direct-Indirect

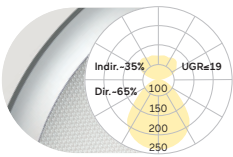

D mm	Colour Temperature	Control	Power	Lumen/Watt	Weight kg	Code Snow White	Code Satin Silver	CHF
450	4000K	On/Off	Medium	2240lm/18W	5,5	MP3AWE-840M-D450-UW	MP3AAE-840M-D450-UA	1645,00
450	4000K	On/Off	High	3870lm/31W	5,5	MP3AWE-840H-D450-UW	MP3AAE-840H-D450-UA	1645,00
650	4000K	On/Off	Medium	5020lm/40W	7,5	MP3AWE-840M-D650-UW	MP3AAE-840M-D650-UA	2538,00
650	4000K	On/Off	High	7720lm/63W	7,5	MP3AWE-840H-D650-UW	MP3AAE-840H-D650-UA	2538,00
850	4000K	On/Off	Medium	7490lm/60W	11,4	MP3AWE-840M-D850-UW	MP3AAE-840M-D850-UA	3798,00
850	4000K	On/Off	High	10240lm/81W	11,4	MP3AWE-840H-D850-UW	MP3AAE-840H-D850-UA	3798,00

Microprismatic | Direct

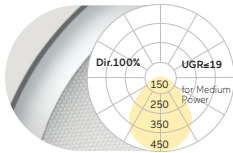

D mm	Colour Temperature	Control	Power	Lumen/Watt	Weight kg	Code Snow White	Code Satin Silver	CHF
450	4000K	On/Off	Medium	1450lm/12W	5,0	MG3AWE-840M-D450-UW	MG3AAE-840M-D450-UA	1488,00
450	4000K	On/Off	High	2510lm/21W	5,0	MG3AWE-840H-D450-UW	MG3AAE-840H-D450-UA	1488,00
650	4000K	On/Off	Medium	3200lm/25W	7,0	MG3AWE-840M-D650-UW	MG3AAE-840M-D650-UA	2345,00
650	4000K	On/Off	High	5200lm/42W	7,0	MG3AWE-840H-D650-UW	MG3AAE-840H-D650-UA	2345,00
850	4000K	On/Off	Medium	5020lm/40W	10,9	MG3AWE-840M-D850-UW	MG3AAE-840M-D850-UA	3588,00
850	4000K	On/Off	High	6790lm/54W	10,9	MG3AWE-840H-D850-UW	MG3AAE-840H-D850-UA	3588,00

Opal Diffuser | Direct-Indirect

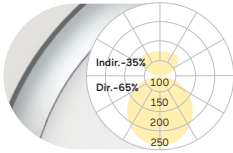

D mm	Colour Temperature	Control	Power	Lumen/Watt	Weight kg	Code Snow White	Code Satin Silver	CHF
450	4000K	On/Off	Medium	2260lm/18W	5,5	MP3OWE-840M-D450-UW	MP3OAE-840M-D450-UA	1593,00
450	4000K	On/Off	High	3910lm/31W	5,5	MP3OWE-840H-D450-UW	MP3OAE-840H-D450-UA	1593,00
650	4000K	On/Off	Medium	5120lm/40W	7,5	MP3OWE-840M-D650-UW	MP3OAE-840M-D650-UA	2468,00
650	4000K	On/Off	High	7890lm/63W	7,5	MP3OWE-840H-D650-UW	MP3OAE-840H-D650-UA	2468,00
850	4000K	On/Off	Medium	7650lm/60W	11,4	MP3OWE-840M-D850-UW	MP3OAE-840M-D850-UA	3710,00
850	4000K	On/Off	High	10460lm/81W	11,4	MP3OWE-840H-D850-UW	MP3OAE-840H-D850-UA	3710,00

Opal Diffuser | Direct

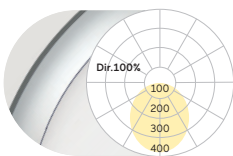

D mm	Colour Temperature	Control	Power	Lumen/Watt	Weight kg	Code Snow White	Code Satin Silver	CHF
450	4000K	On/Off	Medium	1470lm/12W	5,0	MG3OWE-840M-D450-UW	MG3OAE-840M-D450-UA	1435,00
450	4000K	On/Off	High	2550lm/21W	5,0	MG3OWE-840H-D450-UW	MG3OAE-840H-D450-UA	1435,00
650	4000K	On/Off	Medium	3300lm/25W	7,0	MG3OWE-840M-D650-UW	MG3OAE-840M-D650-UA	2275,00
650	4000K	On/Off	High	5370lm/42W	7,0	MG3OWE-840H-D650-UW	MG3OAE-840H-D650-UA	2275,00
850	4000K	On/Off	Medium	5180lm/40W	10,9	MG3OWE-840M-D850-UW	MG3OAE-840M-D850-UA	3500,00
850	4000K	On/Off	High	7010lm/54W	10,9	MG3OWE-840H-D850-UW	MG3OAE-840H-D850-UA	3500,00

Surcharges

Surface / Reflector Finish

Uni-Colours	CHF
W...W: Snow White / Snow White	✓
A...A: Satin Silver / Satin Silver	✓
U...U: Urban Graphite / Urban Graphite	✓
B...B: Jet Black / Jet Black	✓
H...H: Anodic Champ. / Anodic Champ.	✓
K...K: Satin Copper / Satin Copper	✓
Dual Colours	CHF
W...G: Snow White / Satin Gold	+15%
W...K: Snow White / Satin Copper	+15%
W...B: Snow White / Jet Black	+15%
H...B: Anodic Champagne / Jet Black	+15%
B...G: Jet Black / Satin Gold	+15%
B...W: Jet Black / Snow White	+15%

Control Gear

	CHF	CHF
D450-D650		
D850		
E: On/Off	✓	✓
L: DALI	+86,00	+172,00
H: Touch-Dim	+86,00	+172,00
C: Casambi*	+261,00	+261,00
6: DALI DT6 for TW	+172,00	+343,00
8: DALI DT8 for TW	+172,00	+343,00

*Only in combination with DALI. Please add to dimming price.

Colour Rendering

	CHF
8: CRI>80	✓
9: CRI>90	+5%
F: Full Spectrum	+15%

Colour Temperature

	CHF
22: 2200K	+5%
27: 2700K	+5%
30: 3000K	✓
35: 3500K	+5%
40: 4000K	✓
65: 6500K	+5%
TW: Tunable White 2700-6500K* [D650-D850]	+30%

*Only in combination with DT6, DT8 or Casambi control. Please add additional control price.

Suspension

	CHF
U: Central Suspension	✓
K: Parallel Suspension	✓
P: Tube Suspension	+86,00

Additional Options

	CHF
Radar Sensor	+209,00
Emergency Module [DALI, Autotest, incl. 3H Battery] [D650-D850]	+366,00

✓ standard / no extra charge ⚡ on request ✗ not available

Beam Me Up (Max) G1/P1 | Suspended

catalogue page 206



Microprismatic | Direct-Indirect

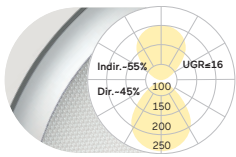

D mm	Colour Temperature	Control	Power	Lumen/Watt	Weight kg	Code Snow White	Code Satin Silver	CHF
400	4000K	On/Off	Medium	2180lm/20W	4,0	MP1AWE-840M-D400-UW	MP1AAE-840M-D400-UA	1661,00
400	4000K	On/Off	High	3190lm/32W	4,0	MP1AWE-840H-D400-UW	MP1AAE-840H-D400-UA	1661,00
700	4000K	On/Off	Medium	5860lm/50W	9,0	MP1AWE-840M-D700-UW	MP1AAE-840M-D700-UA	2447,00
700	4000K	On/Off	High	8590lm/80W	9,0	MP1AWE-840H-D700-UW	MP1AAE-840H-D700-UA	2447,00
1200	4000K	On/Off	Medium	19730lm/177W	25,5	MP1AWE-840M-D1200-UW	MP1AAE-840M-D1200-UA	5592,00
1200	4000K	On/Off	High	27150lm/247W	25,5	MP1AWE-840H-D1200-UW	MP1AAE-840H-D1200-UA	5592,00

Microprismatic | Direct

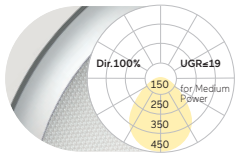

D mm	Colour Temperature	Control	Power	Lumen/Watt	Weight kg	Code Snow White	Code Satin Silver	CHF
400	4000K	On/Off	Medium	1090lm/14W	3,5	MG1AWE-840M-D400-UW	MG1AAE-840M-D400-UA	1574,00
400	4000K	On/Off	High	1600lm/22W	3,5	MG1AWE-840H-D400-UW	MG1AAE-840H-D400-UA	1574,00
700	4000K	On/Off	Medium	2920lm/35W	8,5	MG1AWE-840M-D700-UW	MG1AAE-840M-D700-UA	2272,00
700	4000K	On/Off	High	4290lm/52W	8,5	MG1AWE-840H-D700-UW	MG1AAE-840H-D700-UA	2272,00
1200	4000K	On/Off	Medium	8580lm/104W	22,0	MG1AWE-840M-D1200-UW	MG1AAE-840M-D1200-UA	5233,00
1200	4000K	On/Off	High	11220lm/139W	22,0	MG1AWE-840H-D1200-UW	MG1AAE-840H-D1200-UA	5233,00

Opal Diffuser | Direct-Indirect

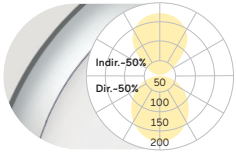

D mm	Colour Temperature	Control	Power	Lumen/Watt	Weight kg	Code Snow White	Code Satin Silver	CHF
400	4000K	On/Off	Medium	2230lm/20W	4,0	MP1OWE-840M-D400-UW	MP1OAE-840M-D400-UA	1574,00
400	4000K	On/Off	High	3270lm/32W	4,0	MP1OWE-840H-D400-UW	MP1OAE-840H-D400-UA	1574,00
700	4000K	On/Off	Medium	6000lm/50W	9,0	MP1OWE-840M-D700-UW	MP1OAE-840M-D700-UA	2258,00
700	4000K	On/Off	High	8790lm/80W	9,0	MP1OWE-840H-D700-UW	MP1OAE-840H-D700-UA	2258,00
1200	4000K	On/Off	Medium	20130lm/177W	25,5	MP1OWE-840M-D1200-UW	MP1OAE-840M-D1200-UA	5233,00
1200	4000K	On/Off	High	27680lm/247W	25,5	MP1OWE-840H-D1200-UW	MP1OAE-840H-D1200-UA	5233,00

Opal Diffuser | Direct

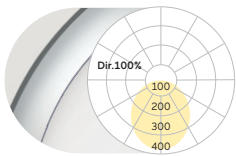

D mm	Colour Temperature	Control	Power	Lumen/Watt	Weight kg	Code Snow White	Code Satin Silver	CHF
400	4000K	On/Off	Medium	1140lm/14W	3,5	MG1OWE-840M-D400-UW	MG1OAE-840M-D400-UA	1486,00
400	4000K	On/Off	High	1680lm/22W	3,5	MG1OWE-840H-D400-UW	MG1OAE-840H-D400-UA	1486,00
700	4000K	On/Off	Medium	3060lm/35W	8,5	MG1OWE-840M-D700-UW	MG1OAE-840M-D700-UA	2083,00
700	4000K	On/Off	High	4490lm/52W	8,5	MG1OWE-840H-D700-UW	MG1OAE-840H-D700-UA	2083,00
1200	4000K	On/Off	Medium	8980lm/104W	22,0	MG1OWE-840M-D1200-UW	MG1OAE-840M-D1200-UA	4883,00
1200	4000K	On/Off	High	11750lm/139W	22,0	MG1OWE-840H-D1200-UW	MG1OAE-840H-D1200-UA	4883,00

Surcharges

Surface / Reflector Finish

Surface / Reflector Finish	CHF
Uni-Colours	
W...W: Snow White / Snow White	✓
A...A: Satin Silver / Satin Silver	✓
U...U: Urban Graphite / Urban Graphite	✓
B...B: Jet Black / Jet Black	✓
H...H: Anodic Champ. / Anodic Champ.	✓
K...K: Satin Copper / Satin Copper	✓
Dual Colours	
W...G: Snow White / Satin Gold	+15%
W...K: Snow White / Satin Copper	+15%
W...B: Snow White / Jet Black	+15%
H...B: Anodic Champagne / Jet Black	+15%
B...G: Jet Black / Satin Gold	+15%
B...W: Jet Black / Snow White	+15%

Control Gear	CHF	CHF
	D450-D700	D1200
E: On/Off	✓	✓
L: DALI	+86,00	+172,00
H: Touch-Dim	+86,00	+172,00
C: Casambi*	+261,00	+261,00
6: DALI DT6 for TW	+172,00	+343,00
8: DALI DT8 for TW	+172,00	+343,00

*Only in combination with DALI. Please add to dimming price.

Colour Rendering	CHF
8: CRI>80	✓
9: CRI>90	+5%
F: Full Spectrum	+15%

Colour Temperature	CHF
22: 2200K	+5%
27: 2700K	+5%
30: 3000K	✓
35: 3500K	+5%
40: 4000K	✓
65: 6500K	+5%
TW: Tunable White 2700-6500K*	+30%

*Only in combination with DT6, DT8 or Casambi control. Please add additional control price.

Suspension	CHF
U: Central Suspension	✓
K: Parallel Suspension	✓
P: Tube Suspension	+86,00

Additional Options	CHF
Radar Sensor	+209,00
Emergency Module [DALI, Autotest, incl. 3H Battery]	+366,00

✓ standard / no extra charge ⚠ on request ✗ not available

Ringo Star Compact G5/P5 | Suspended

catalogue page 208

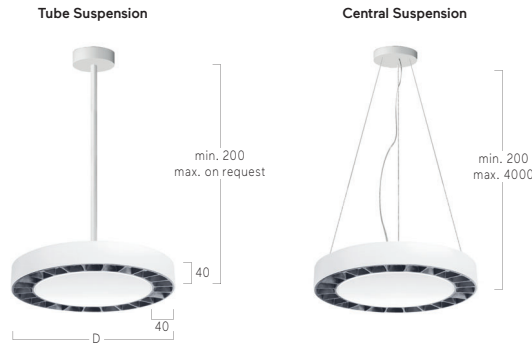

Lens Louvre | Direct-Indirect

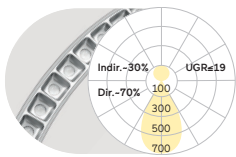

D mm	Colour Temperature	Control	Power	Lumen/Watt	Weight kg	Code Snow White/Jet Black	Code Jet Black/Jet Black	CHF
270	4000K	On/Off	Low	2610lm/19W	2,8	RP5LWE-840E-D270-UB-BP	RP5LBE-840E-D270-UB-BP	1012,00
270	4000K	On/Off	High	4390lm/34W	2,8	RP5LWE-840H-D270-UB-BP	RP5LBE-840H-D270-UB-BP	1012,00
370	4000K	On/Off	Low	3430lm/27W	4,3	RP5LWE-840E-D370-UB-BP	RP5LBE-840E-D370-UB-BP	1257,00
370	4000K	On/Off	High	5800lm/46W	4,3	RP5LWE-840H-D370-UB-BP	RP5LBE-840H-D370-UB-BP	1257,00

Lens Louvre | Direct

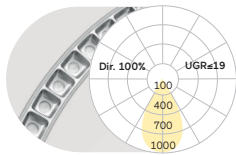

D mm	Colour Temperature	Control	Power	Lumen/Watt	Weight kg	Code Snow White/Jet Black	Code Jet Black/Jet Black	CHF
200	4000K	On/Off	Low	1570lm/13W	1,8	RG5LWE-840E-D200-UB-BP	RG5LBE-840E-D200-UB-BP	697,00
200	4000K	On/Off	High	2660lm/23W	1,8	RG5LWE-840H-D200-UB-BP	RG5LBE-840H-D200-UB-BP	697,00
270	4000K	On/Off	Low	1860lm/15W	2,5	RG5LWE-840E-D270-UB-BP	RG5LBE-840E-D270-UB-BP	872,00
270	4000K	On/Off	High	3110lm/26W	2,5	RG5LWE-840H-D270-UB-BP	RG5LBE-840H-D270-UB-BP	872,00
370	4000K	On/Off	Low	2480lm/20W	4,0	RG5LWE-840E-D370-UB-BP	RG5LBE-840E-D370-UB-BP	1099,00
370	4000K	On/Off	High	4140lm/34W	4,0	RG5LWE-840H-D370-UB-BP	RG5LBE-840H-D370-UB-BP	1099,00



EM Emergency Module



MM Multisensor



Camera

Surcharges

Surface Finish	CHF	Control Gear	CHF	Colour Temperature	CHF	Lens Louvre	CHF	Central Module	CHF
W: Snow White	✓	E: On/Off	✓	22: 2200K	+5%	W: Snow White	✓	BP: Blind Plate	✓
V: Ivory White	✓	L: DALI	+86,00	27: 2700K	+5%	A: Satin Silver	✓	EM: Emergency Module [DALI, Autotest, incl. 3H Battery]	+366,00
A: Satin Silver	+15%	H: Touch-Dim	+86,00	30: 3000K	✓	B: Jet Black	✓	MP: Midpoint Spotlight	+368,00
U: Urban Graphite	✓	Colour Rendering	CHF	35: 3500K	+5%	H: Anodic Champagne	✓	MM: Multisensor	+261,00
B: Jet Black	✓	8: CRI>80	✓	40: 4000K	✓	K: Satin Copper	✓	Additional Options	CHF
H: Anodic Champagne	+10%	9: CRI>90	+5%	65: 6500K	+5%	G: Satin Gold	✓	Casambi	ⓘ
K: Satin Copper	+15%	F: Full Spectrum	+15%			Suspension	CHF	Camera	ⓘ
R: Special RAL/NCS Colours	ⓘ					U: Central Suspension	✓		
						P: Tube Suspension	+86,00		

✓ standard / no extra charge ⓘ on request ✗ not available

Ringo Star GY/PY | System 40mm Suspended

catalogue page 210

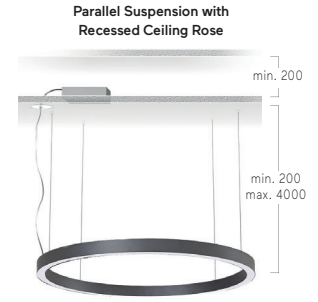
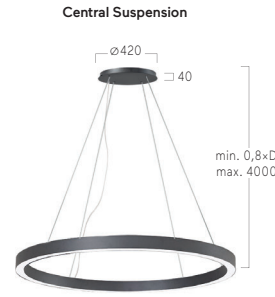
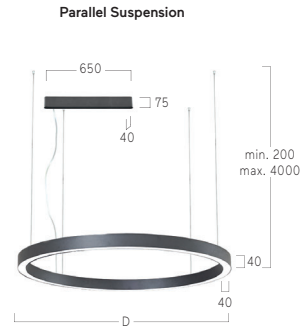

Lens Louvre | Direct-Indirect

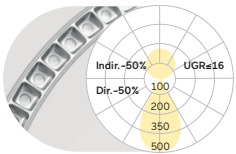

D mm	Colour Temperature	Control	Power	Lumen/Watt	Weight kg	Code Snow White/Jet Black	Code Jet Black/Jet Black	CHF
600	4000K	On/Off	Medium	7920lm/87W	4,5	RPYLWE-840M-D600-KB*	RPYLB E-840M-D600-KB*	2666,00
900	4000K	On/Off	Medium	12180lm/112W	6,5	RPYLWE-840M-D900-KB*	RPYLB E-840M-D900-KB*	3199,00
1245	4000K	On/Off	Medium	16860lm/148W	8,5	RPYLWE-840M-D1245-KB*	RPYLB E-840M-D1245-KB*	3945,00

Lens Louvre | Direct

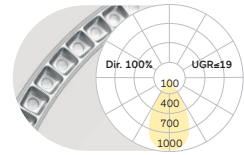

D mm	Colour Temperature	Control	Power	Lumen/Watt	Weight kg	Code Snow White/Jet Black	Code Jet Black/Jet Black	CHF
600	4000K	On/Off	Medium	4030lm/47W	4,2	RGYLWE-840M-D600-KB*	RGYLB E-840M-D600-KB*	2407,00
900	4000K	On/Off	Medium	6200lm/65W	6,2	RGYLWE-840M-D900-KB*	RGYLB E-840M-D900-KB*	2753,00
1245	4000K	On/Off	Medium	8680lm/83W	8,3	RGYLWE-840M-D1245-KB*	RGYLB E-840M-D1245-KB*	3264,00

Opal Flex Diffuser | Direct-Indirect

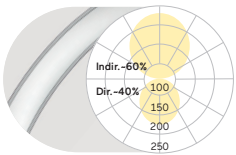

D mm	Colour Temperature	Control	Power	Lumen/Watt	Weight kg	Code Snow White	Code Jet Black	CHF
600	4000K	On/Off	Medium	6570lm/75W	4,5	RPYCW E-840M-D600-K	RPYCB E-840M-D600-K	2317,00
900	4000K	On/Off	Medium	10020lm/101W	6,5	RPYCW E-840M-D900-K	RPYCB E-840M-D900-K	2781,00
1245	4000K	On/Off	Medium	14020lm/142W	8,5	RPYCW E-840M-D1245-K	RPYCB E-840M-D1245-K	3430,00
1500	4000K	On/Off	Medium	16440lm/165W	10,4	RPYCW E-840M-D1500-K	RPYCB E-840M-D1500-K	4440,00
2000	4000K	On/Off	Medium	23210lm/237W	14,0	RPYCW E-840M-D2000-K	RPYCB E-840M-D2000-K	5669,00
2500	4000K	On/Off	Medium	28430lm/287W	17,1	RPYCW E-840M-D2500-K	RPYCB E-840M-D2500-K	6974,00

Opal Flex Diffuser | Direct

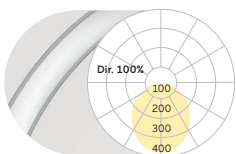

D mm	Colour Temperature	Control	Power	Lumen/Watt	Weight kg	Code Snow White	Code Jet Black	CHF
600	4000K	On/Off	Medium	2680lm/36W	4,2	RGYCW E-840M-D600-K	RGYCB E-840M-D600-K	2188,00
900	4000K	On/Off	Medium	4030lm/54W	6,2	RGYCW E-840M-D900-K	RGYCB E-840M-D900-K	2503,00
1245	4000K	On/Off	Medium	5830lm/77W	8,3	RGYCW E-840M-D1245-K	RGYCB E-840M-D1245-K	2967,00
1500	4000K	On/Off	Medium	6720lm/89W	10,0	RGYCW E-840M-D1500-K	RGYCB E-840M-D1500-K	3779,00
2000	4000K	On/Off	Medium	9420lm/125W	13,5	RGYCW E-840M-D2000-K	RGYCB E-840M-D2000-K	4724,00
2500	4000K	On/Off	Medium	11660lm/154W	16,7	RGYCW E-840M-D2500-K	RGYCB E-840M-D2500-K	5971,00

Surcharges

Surface Finish	CHF	Control Gear	CHF	CHF	Colour Temperature	CHF	Suspension	CHF	Lens Louvre*	CHF
W: Snow White	✓	E: On/Off	✓	D600-D1200	22: 2200K	+5%	U: Central Suspension	✓	W: Snow White	✓
V: Ivory White	✓	L: DALI	+86,00	D1500-D2500	27: 2700K	+5%	K: Parallel Suspension	✓	A: Satin Silver	✓
A: Satin Silver	+15%	H: Touch-Dim	+86,00		30: 3000K	✓	X: Parallel Suspension with Recessed Ceiling Rose	+86,00	B: Jet Black	✓
U: Urban Graphite	✓	C: Casambi*	+261,00		35: 3500K	+5%			H: Anodic Champagne	✓
B: Jet Black	✓				40: 4000K	✓			K: Satin Copper	✓
H: Anodic Champagne	+10%	*Only in combination with DALI. Please add to dimming price.			65: 6500K	+5%			G: Satin Gold	✓
K: Satin Copper	+15%	Colour Rendering	CHF							
R: Special RAL/NCS Colours	ⓘ	8: CRI>80	✓							
		9: CRI>90	+5%							
		F: Full Spectrum	+15%							

✓ standard / no extra charge ⓘ on request ✗ not available

Ringo Star GX/PX | System 40mm Suspended

catalogue page 212



Parallel Suspension

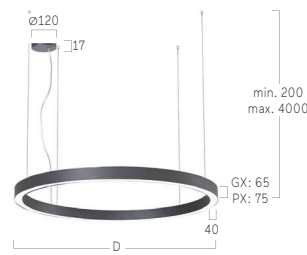

Central Suspension [D600-D2000]



Disc Suspension [D600-D2000]

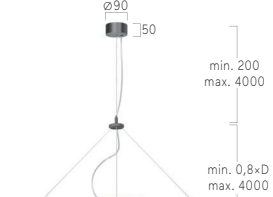

Lens Louvre | Direct-Indirect

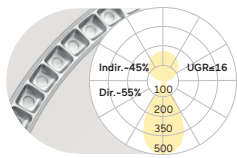

D mm	Colour Temperature	Control	Power	Lumen/Watt	Weight kg	Code Snow White/Jet Black	Code Jet Black/Jet Black	CHF
600	4000K	On/Off	Low	5420lm/43W	6,1	RPXLWE-840E-D600-KB*	RPXLB E-840E-D600-KB*	2827,00
600	4000K	On/Off	Medium	7590lm/61W	6,1	RPXLWE-840M-D600-KB*	RPXLB E-840M-D600-KB*	2827,00
900	4000K	On/Off	Low	8280lm/63W	9,0	RPXLWE-840E-D900-KB*	RPXLB E-840E-D900-KB*	3392,00
900	4000K	On/Off	Medium	11550lm/90W	9,0	RPXLWE-840M-D900-KB*	RPXLB E-840M-D900-KB*	3392,00
1245	4000K	On/Off	Low	11520lm/88W	12,5	RPXLWE-840E-D1245-KB*	RPXLB E-840E-D1245-KB*	4183,00
1245	4000K	On/Off	Medium	16300lm/131W	12,5	RPXLWE-840M-D1245-KB*	RPXLB E-840M-D1245-KB*	4183,00

Lens Louvre | Direct

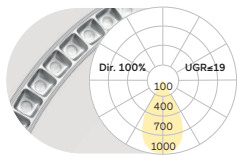

D mm	Colour Temperature	Control	Power	Lumen/Watt	Weight kg	Code Snow White/Jet Black	Code Jet Black/Jet Black	CHF
600	4000K	On/Off	Low	2850lm/23W	4,5	RGXLWE-840E-D600-KB*	RGXLB E-840E-D600-KB*	2552,00
600	4000K	On/Off	High	5170lm/42W	4,5	RGXLWE-840H-D600-KB*	RGXLB E-840H-D600-KB*	2552,00
900	4000K	On/Off	Low	4350lm/33W	6,8	RGXLWE-840E-D900-KB*	RGXLB E-840E-D900-KB*	2919,00
900	4000K	On/Off	High	7980lm/66W	6,8	RGXLWE-840H-D900-KB*	RGXLB E-840H-D900-KB*	2919,00
1245	4000K	On/Off	Low	6090lm/45W	9,4	RGXLWE-840E-D1245-KB*	RGXLB E-840E-D1245-KB*	3460,00
1245	4000K	On/Off	High	11170lm/90W	9,4	RGXLWE-840H-D1245-KB*	RGXLB E-840H-D1245-KB*	3460,00

Opal Flex Diffuser | Direct-Indirect

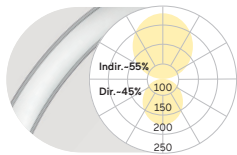

D mm	Colour Temperature	Control	Power	Lumen/Watt	Weight kg	Code Snow White	Code Jet Black	CHF
600	4000K	On/Off	Low	4500lm/41W	6,1	RPXCWE-840E-D600-K	RPXCBE-840E-D600-K	2457,00
600	4000K	On/Off	Medium	6240lm/58W	6,1	RPXCWE-840M-D600-K	RPXCBE-840M-D600-K	2457,00
900	4000K	On/Off	Low	6820lm/60W	9,0	RPXCWE-840E-D900-K	RPXCBE-840E-D900-K	2949,00
900	4000K	On/Off	Medium	9380lm/85W	9,0	RPXCWE-840M-D900-K	RPXCBE-840M-D900-K	2949,00
1245	4000K	On/Off	Low	9510lm/88W	12,5	RPXCWE-840E-D1245-K	RPXCBE-840E-D1245-K	3637,00
1245	4000K	On/Off	Medium	13440lm/124W	12,5	RPXCWE-840M-D1245-K	RPXCBE-840M-D1245-K	3637,00
1500	4000K	On/Off	Low	11680lm/105W	15,1	RPXCWE-840E-D1500-K	RPXCBE-840E-D1500-K	4708,00
1500	4000K	On/Off	Medium	15930lm/145W	15,1	RPXCWE-840M-D1500-K	RPXCBE-840M-D1500-K	4708,00
2000	4000K	On/Off	Low	15670lm/141W	20,1	RPXCWE-840E-D2000-K	RPXCBE-840E-D2000-K	6010,00
2000	4000K	On/Off	Medium	21820lm/200W	20,1	RPXCWE-840M-D2000-K	RPXCBE-840M-D2000-K	6010,00
2500	4000K	On/Off	Low	19440lm/176W	25,0	RPXCWE-840E-D2500-K	RPXCBE-840E-D2500-K	7394,00
2500	4000K	On/Off	Medium	27120lm/249W	25,0	RPXCWE-840M-D2500-K	RPXCBE-840M-D2500-K	7394,00

Opal Flex Diffuser | Direct

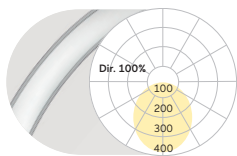

D mm	Colour Temperature	Control	Power	Lumen/Watt	Weight kg	Code Snow White	Code Jet Black	CHF
600	4000K	On/Off	Medium	2680lm/29W	4,5	RGXCWE-840M-D600-K	RGXCBE-840M-D600-K	2319,00
600	4000K	On/Off	High	3740lm/41W	4,5	RGXCWE-840H-D600-K	RGXCBE-840H-D600-K	2319,00
900	4000K	On/Off	Medium	4030lm/43W	6,8	RGXCWE-840M-D900-K	RGXCBE-840M-D900-K	2653,00
900	4000K	On/Off	High	5610lm/62W	6,8	RGXCWE-840H-D900-K	RGXCBE-840H-D900-K	2653,00
1245	4000K	On/Off	Medium	5820lm/62W	9,4	RGXCWE-840M-D1245-K	RGXCBE-840M-D1245-K	3145,00
1245	4000K	On/Off	High	7940lm/89W	9,4	RGXCWE-840H-D1245-K	RGXCBE-840H-D1245-K	3145,00
1500	4000K	On/Off	Medium	6730lm/71W	11,3	RGXCWE-840M-D1500-K	RGXCBE-840M-D1500-K	4006,00
1500	4000K	On/Off	High	9920lm/108W	11,3	RGXCWE-840H-D1500-K	RGXCBE-840H-D1500-K	4006,00
2000	4000K	On/Off	Medium	9400lm/100W	15,1	RGXCWE-840M-D2000-K	RGXCBE-840M-D2000-K	5007,00
2000	4000K	On/Off	High	13210lm/144W	15,1	RGXCWE-840H-D2000-K	RGXCBE-840H-D2000-K	5007,00
2500	4000K	On/Off	Medium	11630lm/125W	19,0	RGXCWE-840M-D2500-K	RGXCBE-840M-D2500-K	6330,00
2500	4000K	On/Off	High	16700lm/182W	19,0	RGXCWE-840H-D2500-K	RGXCBE-840H-D2500-K	6330,00

Surcharges

Surface Finish	CHF
W: Snow White	✓
V: Ivory White	✓
A: Satin Silver	+15%
S: Radiant Silver	✓
U: Urban Graphite	✓
B: Jet Black	✓
H: Anodic Champagne	+10%
K: Satin Copper	+15%
R: Special RAL/NCS Colours	ⓧ

Control Gear	CHF D600-D1200	CHF D1500-D2500
E: On/Off	✓	✓
L: DALI	+86,00	+172,00
H: Touch-Dim	+86,00	+172,00
C: Casambi*	+261,00	+261,00

*Only in combination with DALI. Please add to dimming price.

Colour Rendering	CHF
8: CRI>80	✓
9: CRI>90	+5%
F: Full Spectrum	+15%

Colour Temperature	CHF
22: 2200K	+5%
27: 2700K	+5%
30: 3000K	✓
35: 3500K	+5%
40: 4000K	✓
65: 6500K	+5%

Suspension	CHF
U: Central Suspension [D600-D2000]	✓
K: Parallel Suspension	✓
D: Disc Suspension [D600-D2000]	+137,00

Lens Louvre*	CHF
W: Snow White	✓
A: Satin Silver	✓
B: Jet Black	✓
H: Anodic Champagne	✓
K: Satin Copper	✓
G: Satin Gold	✓

Additional Options	CHF
Midpin Spotlights	+296,00

✓ standard / no extra charge ⓧ on request ✗ not available

Ringo Star Acoustic GY/PY | System 40mm Suspended

catalogue page 214

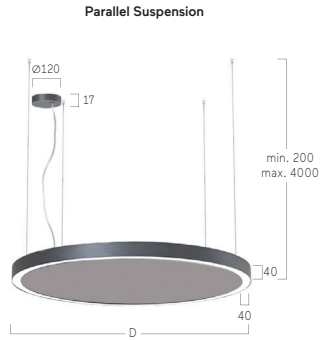

Lens Louvre | Direct-Indirect

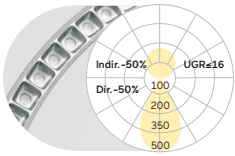

D mm	Colour Temperature	Control	Power	Lumen/Watt	Weight kg	Code Snow White/Jet Black	Code Jet Black/Jet Black	CHF
600	4000K	On/Off	Medium	7920lm/87W	6,0	RPYLWE-840M-D600-KB*-AW	RPYLB E-840M-D600-KB*-AW	3191,00
900	4000K	On/Off	Medium	12180lm/112W	9,0	RPYLWE-840M-D900-KB*-AW	RPYLB E-840M-D900-KB*-AW	3899,00
1245	4000K	On/Off	Medium	16860lm/148W	14,0	RPYLWE-840M-D1245-KB*-AW	RPYLB E-840M-D1245-KB*-AW	4820,00

Lens Louvre | Direct

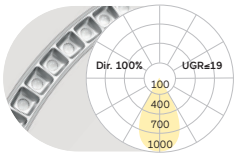

D mm	Colour Temperature	Control	Power	Lumen/Watt	Weight kg	Code Snow White/Jet Black	Code Jet Black/Jet Black	CHF
600	4000K	On/Off	Medium	4030lm/47W	5,2	RGYLWE-840M-D600-KB*-AW	RGYLB E-840M-D600-KB*-AW	2932,00
900	4000K	On/Off	Medium	6200lm/65W	8,6	RGYLWE-840M-D900-KB*-AW	RGYLB E-840M-D900-KB*-AW	3453,00
1245	4000K	On/Off	Medium	8680lm/83W	13,5	RGYLWE-840M-D1245-KB*-AW	RGYLB E-840M-D1245-KB*-AW	4139,00

Opal Flex Diffuser | Direct-Indirect

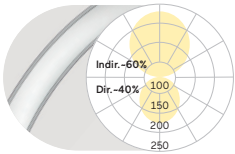

D mm	Colour Temperature	Control	Power	Lumen/Watt	Weight kg	Code Snow White	Code Jet Black	CHF
600	4000K	On/Off	Medium	6570lm/75W	6,5	RPYCW E-840M-D600-K-AW	RPYCB E-840M-D600-K-AW	2842,00
900	4000K	On/Off	Medium	10020lm/101W	8,9	RPYCW E-840M-D900-K-AW	RPYCB E-840M-D900-K-AW	3481,00
1245	4000K	On/Off	Medium	14020lm/142W	13,5	RPYCW E-840M-D1245-K-AW	RPYCB E-840M-D1245-K-AW	4305,00

Opal Flex Diffuser | Direct

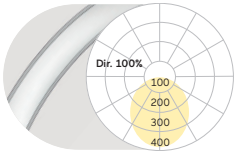

D mm	Colour Temperature	Control	Power	Lumen/Watt	Weight kg	Code Snow White	Code Jet Black	CHF
600	4000K	On/Off	Medium	2680lm/36W	5,2	RGYCW E-840M-D600-K-AW	RGYCB E-840M-D600-K-AW	2713,00
900	4000K	On/Off	Medium	4030lm/54W	8,6	RGYCW E-840M-D900-K-AW	RGYCB E-840M-D900-K-AW	3203,00
1245	4000K	On/Off	Medium	5830lm/77W	13,5	RGYCW E-840M-D1245-K-AW	RGYCB E-840M-D1245-K-AW	3842,00



AW Micro Perforated



BW: Beige Wool

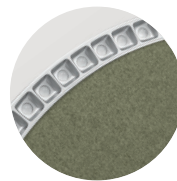

ZW: Green Wool

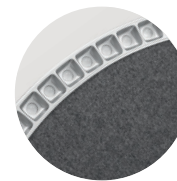

GW: Graphite Wool



AM Green Moss

Surcharges

Surface Finish

Finish	CHF
W: Snow White	✓
V: Ivory White	✓
A: Satin Silver	+15%
S: Radiant Silver	✓
U: Urban Graphite	✓
B: Jet Black	✓
H: Anodic Champagne	+10%
K: Satin Copper	+15%
R: Special RAL/NCS Colours	🔴

Control Gear

Control	CHF
E: On/Off	✓
L: DALI	+86,00
H: Touch-Dim	+86,00
C: Casambi*	+261,00

*Only in combination with DALI. Please add to dimming price.

Colour Rendering

Rendering	CHF
8: CRI>80	✓
9: CRI>90	+5%
F: Full Spectrum	+15%

Colour Temperature

Temp	CHF
22: 2200K	+5%
27: 2700K	+5%
30: 3000K	✓
35: 3500K	+5%
40: 4000K	✓
65: 6500K	+5%

Acoustic Absorber

Absorber	CHF
AW: Micro Perforated	✓
BW: Beige Wool	+5%
ZW: Green Wool	+5%
GW: Graphite Wool	+5%
AM: Green Moss	🔴

Lens Louvre*

Finish	CHF
W: Snow White	✓
A: Satin Silver	✓
B: Jet Black	✓
H: Anodic Champagne	✓
K: Satin Copper	✓
G: Satin Gold	✓

✓ standard / no extra charge 🔴 on request ✗ not available

Ringo Star G3/P3 | System 60mm Suspended

catalogue page 222



Microprismatic | Direct-Indirect

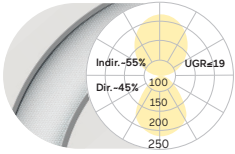

D mm	Colour Temperature	Control	Power	Lumen/Watt	Weight kg	Code Snow White	Code Radiant Silver	CHF
600	4000K	On/Off	Medium	6710lm/62W	7,0	RP3AWE-840M-D600-U	RP3ASE-840M-D600-U	2580,00
900	4000K	On/Off	Medium	10690lm/99W	9,0	RP3AWE-840M-D900-U	RP3ASE-840M-D900-U	3488,00
1200	4000K	On/Off	Medium	13980lm/134W	12,2	RP3AWE-840M-D1200-U	RP3ASE-840M-D1200-U	3859,00
1500	4000K	On/Off	Medium	18860lm/175W	15,9	RP3AWE-840M-D1500-U	RP3ASE-840M-D1500-U	5159,00
2000	4000K	On/Off	Medium	24930lm/239W	20,0	RP3AWE-840M-D2000-U	RP3ASE-840M-D2000-U	8066,00
2500	4000K	On/Off	Medium	26660lm/263W	25,0	RP3AWE-840M-D2500-K	RP3ASE-840M-D2500-K	9186,00
3000	4000K	On/Off	Medium	32410lm/317W	35,0	RP3AWE-840M-D3000-K	RP3ASE-840M-D3000-K	10549,00
3500	4000K	On/Off	Medium	40810lm/397W	41,0	RP3AWE-840M-D3500-K	RP3ASE-840M-D3500-K	12455,00
4000	4000K	On/Off	Medium	43800lm/435W	47,0	RP3AWE-840M-D4000-K	RP3ASE-840M-D4000-K	13822,00
5000	4000K	On/Off	Medium	55690lm/539W	59,0	RP3AWE-840M-D5000-K	RP3ASE-840M-D5000-K	17614,00
6000	4000K	On/Off	Medium	64820lm/635W	71,0	RP3AWE-840M-D6000-K	RP3ASE-840M-D6000-K	20117,00
7000	4000K	On/Off	Medium	74240lm/718W	83,0	RP3AWE-840M-D7000-K	RP3ASE-840M-D7000-K	25699,00
8000	4000K	On/Off	Medium	91060lm/897W	95,0	RP3AWE-840M-D8000-K	RP3ASE-840M-D8000-K	30685,00

Microprismatic | Direct

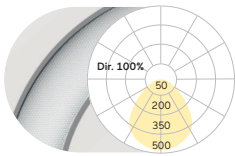

D mm	Colour Temperature	Control	Power	Lumen/Watt	Weight kg	Code Snow White	Code Radiant Silver	CHF
600	4000K	On/Off	Medium	2920lm/37W	6,0	RG3AWE-840M-D600-U	RG3ASE-840M-D600-U	2041,00
600	4000K	On/Off	High	3960lm/53W	6,0	RG3AWE-840H-D600-U	RG3ASE-840H-D600-U	2041,00
900	4000K	On/Off	Medium	4650lm/59W	8,0	RG3AWE-840M-D900-U	RG3ASE-840M-D900-U	2746,00
900	4000K	On/Off	High	6030lm/80W	8,0	RG3AWE-840H-D900-U	RG3ASE-840H-D900-U	2746,00
1200	4000K	On/Off	Medium	6080lm/81W	11,2	RG3AWE-840M-D1200-U	RG3ASE-840M-D1200-U	3117,00
1200	4000K	On/Off	High	8360lm/121W	11,2	RG3AWE-840H-D1200-U	RG3ASE-840H-D1200-U	3117,00
1500	4000K	On/Off	Medium	8220lm/106W	14,9	RG3AWE-840M-D1500-U	RG3ASE-840M-D1500-U	4601,00
1500	4000K	On/Off	High	10700lm/143W	14,9	RG3AWE-840H-D1500-U	RG3ASE-840H-D1500-U	4601,00
2000	4000K	On/Off	Medium	10730lm/142W	19,0	RG3AWE-840M-D2000-U	RG3ASE-840M-D2000-U	7084,00
2000	4000K	On/Off	High	14230lm/203W	19,0	RG3AWE-840H-D2000-U	RG3ASE-840H-D2000-U	7084,00
2500	4000K	On/Off	Medium	13360lm/173W	24,0	RG3AWE-840M-D2500-K	RG3ASE-840M-D2500-K	8028,00
2500	4000K	On/Off	High	17390lm/237W	24,0	RG3AWE-840H-D2500-K	RG3ASE-840H-D2500-K	8028,00
3000	4000K	On/Off	Medium	16450lm/211W	33,0	RG3AWE-840M-D3000-K	RG3ASE-840M-D3000-K	9202,00
3000	4000K	On/Off	High	21400lm/287W	33,0	RG3AWE-840H-D3000-K	RG3ASE-840H-D3000-K	9202,00
3500	4000K	On/Off	Medium	19530lm/259W	37,0	RG3AWE-840M-D3500-K	RG3ASE-840M-D3500-K	10338,00
3500	4000K	On/Off	High	25420lm/352W	37,0	RG3AWE-840H-D3500-K	RG3ASE-840H-D3500-K	10338,00
4000	4000K	On/Off	Medium	22520lm/297W	42,0	RG3AWE-840M-D4000-K	RG3ASE-840M-D4000-K	12089,00
4000	4000K	On/Off	High	29270lm/405W	42,0	RG3AWE-840H-D4000-K	RG3ASE-840H-D4000-K	12089,00
5000	4000K	On/Off	Medium	27760lm/356W	53,0	RG3AWE-840M-D5000-K	RG3ASE-840M-D5000-K	14919,00
5000	4000K	On/Off	High	36120lm/479W	53,0	RG3AWE-840H-D5000-K	RG3ASE-840H-D5000-K	14919,00
6000	4000K	On/Off	Medium	32900lm/423W	66,0	RG3AWE-840M-D6000-K	RG3ASE-840M-D6000-K	18192,00
6000	4000K	On/Off	High	42810lm/574W	66,0	RG3AWE-840H-D6000-K	RG3ASE-840H-D6000-K	18192,00
7000	4000K	On/Off	Medium	37000lm/474W	78,0	RG3AWE-840M-D7000-K	RG3ASE-840M-D7000-K	21657,00
7000	4000K	On/Off	High	48160lm/638W	78,0	RG3AWE-840H-D7000-K	RG3ASE-840H-D7000-K	21657,00
8000	4000K	On/Off	Medium	43180lm/568W	90,0	RG3AWE-840M-D8000-K	RG3ASE-840M-D8000-K	25930,00
8000	4000K	On/Off	High	56190lm/774W	90,0	RG3AWE-840H-D8000-K	RG3ASE-840H-D8000-K	25930,00

Opal Diffuser | Direct-Indirect

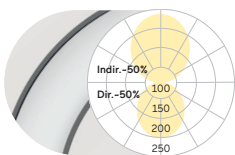

D mm	Colour Temperature	Control	Power	Lumen/Watt	Weight kg	Code Snow White	Code Radiant Silver	CHF
600	4000K	On/Off	Medium	6960lm/62W	7,0	RP3OWE-840M-D600-U	RP3OSE-840M-D600-U	2394,00
900	4000K	On/Off	Medium	11090lm/99W	9,0	RP3OWE-840M-D900-U	RP3OSE-840M-D900-U	3136,00
1200	4000K	On/Off	Medium	14500lm/134W	12,2	RP3OWE-840M-D1200-U	RP3OSE-840M-D1200-U	3507,00
1500	4000K	On/Off	Medium	19560lm/175W	15,9	RP3OWE-840M-D1500-U	RP3OSE-840M-D1500-U	4582,00
2000	4000K	On/Off	Medium	25850lm/239W	20,0	RP3OWE-840M-D2000-U	RP3OSE-840M-D2000-U	7296,00
2500	4000K	On/Off	Medium	27800lm/263W	25,0	RP3OWE-840M-D2500-K	RP3OSE-840M-D2500-K	8624,00
3000	4000K	On/Off	Medium	33810lm/317W	35,0	RP3OWE-840M-D3000-K	RP3OSE-840M-D3000-K	9799,00
3500	4000K	On/Off	Medium	42480lm/397W	41,0	RP3OWE-840M-D3500-K	RP3OSE-840M-D3500-K	11300,00
4000	4000K	On/Off	Medium	45720lm/435W	47,0	RP3OWE-840M-D4000-K	RP3OSE-840M-D4000-K	12859,00
5000	4000K	On/Off	Medium	58050lm/539W	59,0	RP3OWE-840M-D5000-K	RP3OSE-840M-D5000-K	16671,00
6000	4000K	On/Off	Medium	67620lm/635W	71,0	RP3OWE-840M-D6000-K	RP3OSE-840M-D6000-K	19019,00
7000	4000K	On/Off	Medium	77400lm/718W	83,0	RP3OWE-840M-D7000-K	RP3OSE-840M-D7000-K	24544,00
8000	4000K	On/Off	Medium	94730lm/897W	95,0	RP3OWE-840M-D8000-K	RP3OSE-840M-D8000-K	29260,00

... Ringo Star G3/P3 | System 60mm Suspended

Opal Diffuser | Direct

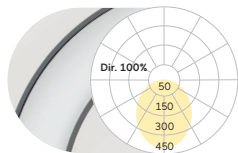

D mm	Colour Temperature	Control	Power	Lumen/Watt	Weight kg	Code Snow White	Code Radiant Silver	CHF
600	4000K	On/Off	Medium	3170lm/37W	6,0	RG3OWE-840M-D600-U	RG3OSE-840M-D600-U	1948,00
600	4000K	On/Off	High	4300lm/53W	6,0	RG3OWE-840H-D600-U	RG3OSE-840H-D600-U	1948,00
900	4000K	On/Off	Medium	5050lm/59W	8,0	RG3OWE-840M-D900-U	RG3OSE-840M-D900-U	2580,00
900	4000K	On/Off	High	6540lm/80W	8,0	RG3OWE-840H-D900-U	RG3OSE-840H-D900-U	2580,00
1200	4000K	On/Off	Medium	6600lm/81W	11,2	RG3OWE-840M-D1200-U	RG3OSE-840M-D1200-U	2951,00
1200	4000K	On/Off	High	9080lm/121W	11,2	RG3OWE-840H-D1200-U	RG3OSE-840H-D1200-U	2951,00
1500	4000K	On/Off	Medium	8920lm/106W	14,9	RG3OWE-840M-D1500-U	RG3OSE-840M-D1500-U	4024,00
1500	4000K	On/Off	High	11610lm/143W	14,9	RG3OWE-840H-D1500-U	RG3OSE-840H-D1500-U	4024,00
2000	4000K	On/Off	Medium	11650lm/142W	19,0	RG3OWE-840M-D2000-U	RG3OSE-840M-D2000-U	6507,00
2000	4000K	On/Off	High	15450lm/203W	19,0	RG3OWE-840H-D2000-U	RG3OSE-840H-D2000-U	6507,00
2500	4000K	On/Off	Medium	14500lm/173W	24,0	RG3OWE-840M-D2500-K	RG3OSE-840M-D2500-K	7489,00
2500	4000K	On/Off	High	18870lm/237W	24,0	RG3OWE-840H-D2500-K	RG3OSE-840H-D2500-K	7489,00
3000	4000K	On/Off	Medium	17850lm/211W	33,0	RG3OWE-840M-D3000-K	RG3OSE-840M-D3000-K	8451,00
3000	4000K	On/Off	High	23230lm/287W	33,0	RG3OWE-840H-D3000-K	RG3OSE-840H-D3000-K	8451,00
3500	4000K	On/Off	Medium	21200lm/259W	37,0	RG3OWE-840M-D3500-K	RG3OSE-840M-D3500-K	9589,00
3500	4000K	On/Off	High	27580lm/352W	37,0	RG3OWE-840H-D3500-K	RG3OSE-840H-D3500-K	9589,00
4000	4000K	On/Off	Medium	24440lm/297W	42,0	RG3OWE-840M-D4000-K	RG3OSE-840M-D4000-K	11146,00
4000	4000K	On/Off	High	31760lm/405W	42,0	RG3OWE-840H-D4000-K	RG3OSE-840H-D4000-K	11146,00
5000	4000K	On/Off	Medium	30120lm/356W	53,0	RG3OWE-840M-D5000-K	RG3OSE-840M-D5000-K	14399,00
5000	4000K	On/Off	High	39200lm/479W	53,0	RG3OWE-840H-D5000-K	RG3OSE-840H-D5000-K	14399,00
6000	4000K	On/Off	Medium	35700lm/423W	66,0	RG3OWE-840M-D6000-K	RG3OSE-840M-D6000-K	17114,00
6000	4000K	On/Off	High	46450lm/574W	66,0	RG3OWE-840H-D6000-K	RG3OSE-840H-D6000-K	17114,00
7000	4000K	On/Off	Medium	40160lm/474W	78,0	RG3OWE-840M-D7000-K	RG3OSE-840M-D7000-K	20117,00
7000	4000K	On/Off	High	52260lm/638W	78,0	RG3OWE-840H-D7000-K	RG3OSE-840H-D7000-K	20117,00
8000	4000K	On/Off	Medium	46850lm/568W	90,0	RG3OWE-840M-D8000-K	RG3OSE-840M-D8000-K	23659,00
8000	4000K	On/Off	High	60970lm/774W	90,0	RG3OWE-840H-D8000-K	RG3OSE-840H-D8000-K	23659,00



Midpin Spotlight XP
770lm/10W/Ø40mm

Surcharges

Surface Finish

- W: Snow White
- V: Ivory White
- S: Radiant Silver
- U: Urban Graphite
- B: Jet Black
- H: Anodic Champagne
- K: Satin Copper
- R: Special RAL/NCS Colours

CHF

- ✓
- ✓
- ✓
- ✓
- ✓
- +10%
- +15%
- ⚠

Control Gear

- E: On/Off
- L: DALI
- H: Touch-Dim
- C: Casambi*
- 6: DALI DT6 for TW
- 8: DALI DT8 for TW
- U: Separately Dimmable DALI

*Only in combination with DALI. Please add to dimming price.

CHF

- ✓
- ⚠
- ⚠
- ⚠
- ⚠
- ⚠
- ⚠

CHF

- ✓
- ⚠
- ⚠
- ⚠
- ⚠
- ⚠
- ⚠

CHF

- ✓
- ⚠
- ⚠
- ⚠
- ⚠
- ⚠
- ⚠

Colour Rendering

- 8: CRI>80
- 9: CRI>90
- F: Full Spectrum

*Only in combination with DT6, DT8 or Casambi control. Please add additional control price.

Colour Temperature

- 22: 2200K
- 27: 2700K
- 30: 3000K
- 35: 3500K
- 40: 4000K
- 65: 6500K
- TW: Tunable White 2700-6500K* [D1500-D8000]

CHF

- ✓
- +5%
- +15%
- CHF
- +5%
- +5%
- +5%
- +5%
- +30%

Suspension Type

- U: Central Suspension [D600-D2000]
- K: Parallel Suspension
- D: Disc Suspension [D600-D2000]

Additional Options

- Emergency Module [DALI, Autotest, incl. 3H Battery] [D1500-D8000]
- Midpin Spotlight XP

CHF

- ✓
- ✓
- +139,00
- CHF
- +366,00
- +433,00

✓ standard / no extra charge ⚠ on request ✗ not available

Ringo Star Acoustic G3/P3 | System 60mm Suspended

catalogue page 224



Parallel Suspension



Central Suspension



Microprismatic | Direct-Indirect

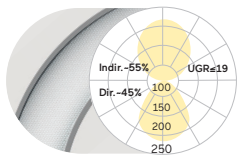

D mm	Colour Temperature	Control	Power	Lumen/Watt	Weight kg	Code Snow White	Code Radiant Silver	CHF
600	4000K	On/Off	Medium	6710lm/62W	8,6	RP3AWE-840M-D600-K-AW	RP3ASE-840M-D600-K-AW	3105,00
900	4000K	On/Off	Medium	10690lm/99W	13,5	RP3AWE-840M-D900-K-AW	RP3ASE-840M-D900-K-AW	4188,00
1200	4000K	On/Off	Medium	13980lm/134W	21,0	RP3AWE-840M-D1200-K-AW	RP3ASE-840M-D1200-K-AW	4734,00
1500	4000K	On/Off	Medium	18860lm/175W	30,0	RP3AWE-840M-D1500-K-AW	RP3ASE-840M-D1500-K-AW	6470,00
2000	4000K	On/Off	Medium	24930lm/239W	46,6	RP3AWE-840M-D2000-K-AW	RP3ASE-840M-D2000-K-AW	10341,00

Microprismatic | Direct

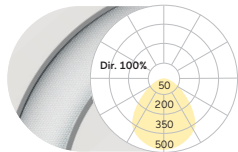

D mm	Colour Temperature	Control	Power	Lumen/Watt	Weight kg	Code Snow White	Code Radiant Silver	CHF
600	4000K	On/Off	Medium	2920lm/37W	7,6	RG3AWE-840M-D600-K-AW	RG3ASE-840M-D600-K-AW	2566,00
600	4000K	On/Off	High	3960lm/53W	7,6	RG3AWE-840H-D600-K-AW	RG3ASE-840H-D600-K-AW	2566,00
900	4000K	On/Off	Medium	4650lm/59W	12,5	RG3AWE-840M-D900-K-AW	RG3ASE-840M-D900-K-AW	3446,00
900	4000K	On/Off	High	6030lm/80W	12,5	RG3AWE-840H-D900-K-AW	RG3ASE-840H-D900-K-AW	3446,00
1200	4000K	On/Off	Medium	6080lm/81W	20,0	RG3AWE-840M-D1200-K-AW	RG3ASE-840M-D1200-K-AW	3990,00
1200	4000K	On/Off	High	8360lm/121W	20,0	RG3AWE-840H-D1200-K-AW	RG3ASE-840H-D1200-K-AW	3990,00
1500	4000K	On/Off	Medium	8220lm/106W	29,0	RG3AWE-840M-D1500-K-AW	RG3ASE-840M-D1500-K-AW	5912,00
1500	4000K	On/Off	High	10700lm/143W	29,0	RG3AWE-840H-D1500-K-AW	RG3ASE-840H-D1500-K-AW	5912,00
2000	4000K	On/Off	Medium	10730lm/142W	45,6	RG3AWE-840M-D2000-K-AW	RG3ASE-840M-D2000-K-AW	9359,00
2000	4000K	On/Off	High	14230lm/203W	45,6	RG3AWE-840H-D2000-K-AW	RG3ASE-840H-D2000-K-AW	9359,00

Opal Diffuser | Direct-Indirect

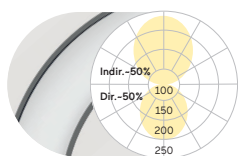

D mm	Colour Temperature	Control	Power	Lumen/Watt	Weight kg	Code Snow White	Code Radiant Silver	CHF
600	4000K	On/Off	Medium	6960lm/62W	8,6	RP3OWE-840M-D600-K-AW	RP3OSE-840M-D600-K-AW	2919,00
900	4000K	On/Off	Medium	11090lm/99W	13,5	RP3OWE-840M-D900-K-AW	RP3OSE-840M-D900-K-AW	3836,00
1200	4000K	On/Off	Medium	14500lm/134W	21,0	RP3OWE-840M-D1200-K-AW	RP3OSE-840M-D1200-K-AW	4382,00
1500	4000K	On/Off	Medium	19560lm/175W	30,0	RP3OWE-840M-D1500-K-AW	RP3OSE-840M-D1500-K-AW	5893,00
2000	4000K	On/Off	Medium	25850lm/239W	46,6	RP3OWE-840M-D2000-K-AW	RP3OSE-840M-D2000-K-AW	9571,00

Opal Diffuser | Direct

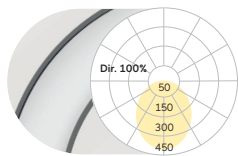

D mm	Colour Temperature	Control	Power	Lumen/Watt	Weight kg	Code Snow White	Code Radiant Silver	CHF
600	4000K	On/Off	Medium	3170lm/37W	7,6	RG3OWE-840M-D600-K-AW	RG3OSE-840M-D600-K-AW	2473,00
600	4000K	On/Off	High	4300lm/53W	7,6	RG3OWE-840H-D600-K-AW	RG3OSE-840H-D600-K-AW	2473,00
900	4000K	On/Off	Medium	5050lm/59W	12,5	RG3OWE-840M-D900-K-AW	RG3OSE-840M-D900-K-AW	3280,00
900	4000K	On/Off	High	6540lm/80W	12,5	RG3OWE-840H-D900-K-AW	RG3OSE-840H-D900-K-AW	3280,00
1200	4000K	On/Off	Medium	6600lm/81W	20,0	RG3OWE-840M-D1200-K-AW	RG3OSE-840M-D1200-K-AW	3826,00
1200	4000K	On/Off	High	9080lm/121W	20,0	RG3OWE-840H-D1200-K-AW	RG3OSE-840H-D1200-K-AW	3826,00
1500	4000K	On/Off	Medium	8920lm/106W	29,0	RG3OWE-840M-D1500-K-AW	RG3OSE-840M-D1500-K-AW	6384,00
1500	4000K	On/Off	High	11610lm/143W	29,0	RG3OWE-840H-D1500-K-AW	RG3OSE-840H-D1500-K-AW	6384,00
2000	4000K	On/Off	Medium	11650lm/142W	45,6	RG3OWE-840M-D2000-K-AW	RG3OSE-840M-D2000-K-AW	8782,00
2000	4000K	On/Off	High	15450lm/203W	45,6	RG3OWE-840H-D2000-K-AW	RG3OSE-840H-D2000-K-AW	8782,00



AW Micro Perforated

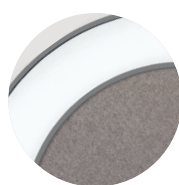

BW: Beige Wool

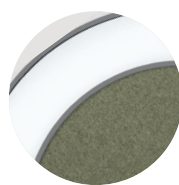

ZW: Green Wool

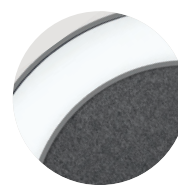

GW: Graphite Wool

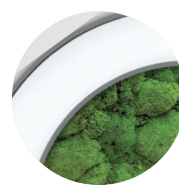

AM Green Moss

Surcharges

Surface Finish

Surface Finish	CHF
W: Snow White	✓
V: Ivory White	✓
S: Radiant Silver	✓
U: Urban Graphite	✓
B: Jet Black	✓
H: Anodic Champagne	+10%
K: Satin Copper	+15%
R: Special RAL/NCS Colours	⚠

Control Gear

Control Gear	CHF	CHF
E: On/Off	✓	✓
L: DALI	+86,00	+172,00
H: Touch-Dim	+86,00	+172,00
C: Casambi*	+261,00	+261,00
6: DALI DT6 for TW	+172,00	+343,00
8: DALI DT8 for TW	+172,00	+343,00
U: Separately Dimmable DALI	+172,00	+343,00

Colour Rendering

Colour Rendering	CHF
8: CRI>80	✓
9: CRI>90	+5%
F: Full Spectrum	+15%

Colour Temperature

Colour Temperature	CHF
22: 2200K	+5%
27: 2700K	+5%
30: 3000K	✓
35: 3500K	+5%
40: 4000K	✓
65: 6500K	+5%
TW: Tunable White 2700-6500K* [D1500-D2000]	+30%

Suspension Type

Suspension Type	CHF
U: Central Suspension	✓
K: Parallel Suspension	✓

Acoustic Absorber

Acoustic Absorber	CHF
AW: Micro Perforated	✓
BW: Beige Wool [D600-D1500]	+5%
ZW: Green Wool [D600-D1500]	+5%
GW: Graphite Wool [D600-D1500]	+5%
AM: Green Moss	⚠

Additional Options

Additional Options	CHF
Emergency Module [DALI, Autotest, incl. 3H Battery] [D1500-D2000]	+366,00

✓ standard / no extra charge ⚠ on request ✗ not available

*Only in combination with DT6, DT8 or Casambi control. Please add additional control price.

Ringo Star G1/P1 | System 100mm Suspended

catalogue page 226



Microprismatic | Direct-Indirect

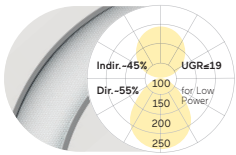

D mm	Colour Temperature	Control	Power	Lumen/Watt	Weight kg	Code Snow White	Code Radiant Silver	CHF
600	4000K	On/Off	Low	7510lm/59W	7,5	RP1AWE-840E-D600-U	RP1ASE-840E-D600-U	2704,00
600	4000K	On/Off	Medium	9860lm/79W	7,5	RP1AWE-840M-D600-U	RP1ASE-840M-D600-U	2704,00
900	4000K	On/Off	Low	12360lm/99W	11,0	RP1AWE-840E-D900-U	RP1ASE-840E-D900-U	3768,00
900	4000K	On/Off	Medium	16510lm/134W	11,0	RP1AWE-840M-D900-U	RP1ASE-840M-D900-U	3768,00
1200	4000K	On/Off	Low	16240lm/128W	14,0	RP1AWE-840E-D1200-U	RP1ASE-840E-D1200-U	4561,00
1200	4000K	On/Off	Medium	21930lm/174W	14,0	RP1AWE-840M-D1200-U	RP1ASE-840M-D1200-U	4561,00
1500	4000K	On/Off	Low	21000lm/162W	18,0	RP1AWE-840E-D1500-U	RP1ASE-840E-D1500-U	5390,00
1500	4000K	On/Off	Medium	27850lm/218W	18,0	RP1AWE-840M-D1500-U	RP1ASE-840M-D1500-U	5390,00
2000	4000K	On/Off	Low	28010lm/218W	22,0	RP1AWE-840E-D2000-U	RP1ASE-840E-D2000-U	8794,00
2000	4000K	On/Off	Medium	37860lm/299W	22,0	RP1AWE-840M-D2000-U	RP1ASE-840M-D2000-U	8794,00
2500	4000K	On/Off	Low	33400lm/261W	31,0	RP1AWE-840E-D2500-K	RP1ASE-840E-D2500-K	10500,00
2500	4000K	On/Off	Medium	44410lm/349W	31,0	RP1AWE-840M-D2500-K	RP1ASE-840M-D2500-K	10500,00
3000	4000K	On/Off	Low	39080lm/305W	38,0	RP1AWE-840E-D3000-K	RP1ASE-840E-D3000-K	12541,00
3000	4000K	On/Off	Medium	51680lm/406W	38,0	RP1AWE-840M-D3000-K	RP1ASE-840M-D3000-K	12541,00
3500	4000K	On/Off	Low	44630lm/345W	44,0	RP1AWE-840E-D3500-K	RP1ASE-840E-D3500-K	14674,00
3500	4000K	On/Off	Medium	59110lm/459W	44,0	RP1AWE-840M-D3500-K	RP1ASE-840M-D3500-K	14674,00
4000	4000K	On/Off	Low	54260lm/421W	50,0	RP1AWE-840E-D4000-K	RP1ASE-840E-D4000-K	16715,00
4000	4000K	On/Off	Medium	72180lm/565W	50,0	RP1AWE-840M-D4000-K	RP1ASE-840M-D4000-K	16715,00
5000	4000K	On/Off	Low	64170lm/506W	62,0	RP1AWE-840E-D5000-K	RP1ASE-840E-D5000-K	20759,00
5000	4000K	On/Off	Medium	84940lm/674W	62,0	RP1AWE-840M-D5000-K	RP1ASE-840M-D5000-K	20759,00
6000	4000K	On/Off	Low	78160lm/610W	75,0	RP1AWE-840E-D6000-K	RP1ASE-840E-D6000-K	24784,00
6000	4000K	On/Off	Medium	103350lm/811W	75,0	RP1AWE-840M-D6000-K	RP1ASE-840M-D6000-K	24784,00
7000	4000K	On/Off	Low	97430lm/763W	88,0	RP1AWE-840E-D7000-K	RP1ASE-840E-D7000-K	28884,00
7000	4000K	On/Off	Medium	129520lm/1022W	88,0	RP1AWE-840M-D7000-K	RP1ASE-840M-D7000-K	28884,00
8000	4000K	On/Off	Low	107920lm/831W	100,0	RP1AWE-840E-D8000-K	RP1ASE-840E-D8000-K	32965,00
8000	4000K	On/Off	Medium	143320lm/1112W	100,0	RP1AWE-840M-D8000-K	RP1ASE-840M-D8000-K	32965,00

Microprismatic | Direct

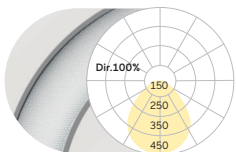

D mm	Colour Temperature	Control	Power	Lumen/Watt	Weight kg	Code Snow White	Code Radiant Silver	CHF
600	4000K	On/Off	Low	3810lm/34W	6,1	RG1AWE-840E-D600-U	RG1ASE-840E-D600-U	2237,00
600	4000K	On/Off	Medium	4790lm/45W	6,1	RG1AWE-840M-D600-U	RG1ASE-840M-D600-U	2237,00
900	4000K	On/Off	Low	6460lm/59W	10,0	RG1AWE-840E-D900-U	RG1ASE-840E-D900-U	3065,00
900	4000K	On/Off	Medium	7900lm/75W	10,0	RG1AWE-840M-D900-U	RG1ASE-840M-D900-U	3065,00
1200	4000K	On/Off	Low	8750lm/79W	13,0	RG1AWE-840E-D1200-U	RG1ASE-840E-D1200-U	4146,00
1200	4000K	On/Off	Medium	10260lm/95W	13,0	RG1AWE-840M-D1200-U	RG1ASE-840M-D1200-U	4146,00
1500	4000K	On/Off	Low	10980lm/98W	17,0	RG1AWE-840E-D1500-U	RG1ASE-840E-D1500-U	4813,00
1500	4000K	On/Off	Medium	13200lm/120W	17,0	RG1AWE-840M-D1500-U	RG1ASE-840M-D1500-U	4813,00
2000	4000K	On/Off	Low	14650lm/131W	20,0	RG1AWE-840E-D2000-U	RG1ASE-840E-D2000-U	7310,00
2000	4000K	On/Off	Medium	18330lm/168W	20,0	RG1AWE-840M-D2000-U	RG1ASE-840M-D2000-U	7310,00
2500	4000K	On/Off	Low	18900lm/166W	29,0	RG1AWE-840E-D2500-K	RG1ASE-840E-D2500-K	9090,00
2500	4000K	On/Off	Medium	23090lm/207W	29,0	RG1AWE-840M-D2500-K	RG1ASE-840M-D2500-K	9090,00
3000	4000K	On/Off	Low	23260lm/202W	34,0	RG1AWE-840E-D3000-K	RG1ASE-840E-D3000-K	10852,00
3000	4000K	On/Off	Medium	28420lm/252W	34,0	RG1AWE-840M-D3000-K	RG1ASE-840M-D3000-K	10852,00
3500	4000K	On/Off	Low	26170lm/227W	40,0	RG1AWE-840E-D3500-K	RG1ASE-840E-D3500-K	12243,00
3500	4000K	On/Off	Medium	31970lm/281W	40,0	RG1AWE-840M-D3500-K	RG1ASE-840M-D3500-K	12243,00
4000	4000K	On/Off	Low	30530lm/271W	46,0	RG1AWE-840E-D4000-K	RG1ASE-840E-D4000-K	14137,00
4000	4000K	On/Off	Medium	37290lm/338W	46,0	RG1AWE-840M-D4000-K	RG1ASE-840M-D4000-K	14137,00
5000	4000K	On/Off	Low	37800lm/332W	58,0	RG1AWE-840E-D5000-K	RG1ASE-840E-D5000-K	17549,00
5000	4000K	On/Off	Medium	46170lm/414W	58,0	RG1AWE-840M-D5000-K	RG1ASE-840M-D5000-K	17549,00
6000	4000K	On/Off	Low	46520lm/405W	69,0	RG1AWE-840E-D6000-K	RG1ASE-840E-D6000-K	21037,00
6000	4000K	On/Off	Medium	56830lm/504W	69,0	RG1AWE-840M-D6000-K	RG1ASE-840M-D6000-K	21037,00
7000	4000K	On/Off	Low	55240lm/496W	81,0	RG1AWE-840E-D7000-K	RG1ASE-840E-D7000-K	24376,00
7000	4000K	On/Off	Medium	67490lm/617W	81,0	RG1AWE-840M-D7000-K	RG1ASE-840M-D7000-K	24376,00
8000	4000K	On/Off	Low	61780lm/536W	92,0	RG1AWE-840E-D8000-K	RG1ASE-840E-D8000-K	27825,00
8000	4000K	On/Off	Medium	75480lm/667W	92,0	RG1AWE-840M-D8000-K	RG1ASE-840M-D8000-K	27825,00

Opal Diffuser | Direct-Indirect

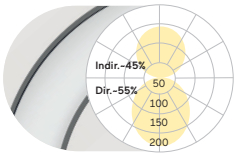

D mm	Colour Temperature	Control	Power	Lumen/Watt	Weight kg	Code Snow White	Code Radiant Silver	CHF
600	4000K	On/Off	Low	7790lm/59W	7,5	RP1OWE-840E-D600-U	RP1OSE-840E-D600-U	2615,00
600	4000K	On/Off	Medium	10220lm/79W	7,5	RP1OWE-840M-D600-U	RP1OSE-840M-D600-U	2615,00
900	4000K	On/Off	Low	12830lm/99W	11,0	RP1OWE-840E-D900-U	RP1OSE-840E-D900-U	3588,00
900	4000K	On/Off	Medium	17100lm/134W	11,0	RP1OWE-840M-D900-U	RP1OSE-840M-D900-U	3588,00
1200	4000K	On/Off	Low	16890lm/128W	14,0	RP1OWE-840E-D1200-U	RP1OSE-840E-D1200-U	4291,00
1200	4000K	On/Off	Medium	22700lm/174W	14,0	RP1OWE-840M-D1200-U	RP1OSE-840M-D1200-U	4291,00
1500	4000K	On/Off	Low	21820lm/162W	18,0	RP1OWE-840E-D1500-U	RP1OSE-840E-D1500-U	5005,00
1500	4000K	On/Off	Medium	28830lm/218W	18,0	RP1OWE-840M-D1500-U	RP1OSE-840M-D1500-U	5005,00
2000	4000K	On/Off	Low	29090lm/218W	22,0	RP1OWE-840E-D2000-U	RP1OSE-840E-D2000-U	8330,00
2000	4000K	On/Off	Medium	39220lm/299W	22,0	RP1OWE-840M-D2000-U	RP1OSE-840M-D2000-U	8330,00
2500	4000K	On/Off	Low	34800lm/261W	31,0	RP1OWE-840E-D2500-K	RP1OSE-840E-D2500-K	9944,00
2500	4000K	On/Off	Medium	46120lm/349W	31,0	RP1OWE-840M-D2500-K	RP1OSE-840M-D2500-K	9944,00
3000	4000K	On/Off	Low	40810lm/305W	38,0	RP1OWE-840E-D3000-K	RP1OSE-840E-D3000-K	11892,00
3000	4000K	On/Off	Medium	53780lm/406W	38,0	RP1OWE-840M-D3000-K	RP1OSE-840M-D3000-K	11892,00
3500	4000K	On/Off	Low	46570lm/345W	44,0	RP1OWE-840E-D3500-K	RP1OSE-840E-D3500-K	13932,00
3500	4000K	On/Off	Medium	61480lm/459W	44,0	RP1OWE-840M-D3500-K	RP1OSE-840M-D3500-K	13932,00
4000	4000K	On/Off	Low	56520lm/421W	50,0	RP1OWE-840E-D4000-K	RP1OSE-840E-D4000-K	15880,00
4000	4000K	On/Off	Medium	74950lm/565W	50,0	RP1OWE-840M-D4000-K	RP1OSE-840M-D4000-K	15880,00
5000	4000K	On/Off	Low	66970lm/506W	62,0	RP1OWE-840E-D5000-K	RP1OSE-840E-D5000-K	19831,00
5000	4000K	On/Off	Medium	88370lm/674W	62,0	RP1OWE-840M-D5000-K	RP1OSE-840M-D5000-K	19831,00
6000	4000K	On/Off	Low	81610lm/610W	75,0	RP1OWE-840E-D6000-K	RP1OSE-840E-D6000-K	23764,00
6000	4000K	On/Off	Medium	107570lm/811W	75,0	RP1OWE-840M-D6000-K	RP1OSE-840M-D6000-K	23764,00
7000	4000K	On/Off	Low	101530lm/763W	88,0	RP1OWE-840E-D7000-K	RP1OSE-840E-D7000-K	27771,00
7000	4000K	On/Off	Medium	134530lm/1022W	88,0	RP1OWE-840M-D7000-K	RP1OSE-840M-D7000-K	27771,00
8000	4000K	On/Off	Low	112510lm/831W	100,0	RP1OWE-840E-D8000-K	RP1OSE-840E-D8000-K	31759,00
8000	4000K	On/Off	Medium	148920lm/1112W	100,0	RP1OWE-840M-D8000-K	RP1OSE-840M-D8000-K	31759,00

Opal Diffuser | Direct

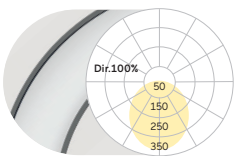

D mm	Colour Temperature	Control	Power	Lumen/Watt	Weight kg	Code Snow White	Code Radiant Silver	CHF
600	4000K	On/Off	Low	4090lm/34W	6,1	RG1OWE-840E-D600-U	RG1OSE-840E-D600-U	2146,00
600	4000K	On/Off	Medium	5150lm/45W	6,1	RG1OWE-840M-D600-U	RG1OSE-840M-D600-U	2146,00
900	4000K	On/Off	Low	6930lm/59W	10,0	RG1OWE-840E-D900-U	RG1OSE-840E-D900-U	2884,00
900	4000K	On/Off	Medium	8490lm/75W	10,0	RG1OWE-840M-D900-U	RG1OSE-840M-D900-U	2884,00
1200	4000K	On/Off	Low	9400lm/79W	13,0	RG1OWE-840E-D1200-U	RG1OSE-840E-D1200-U	3877,00
1200	4000K	On/Off	Medium	11030lm/95W	13,0	RG1OWE-840M-D1200-U	RG1OSE-840M-D1200-U	3877,00
1500	4000K	On/Off	Low	11800lm/98W	17,0	RG1OWE-840E-D1500-U	RG1OSE-840E-D1500-U	4428,00
1500	4000K	On/Off	Medium	14180lm/120W	17,0	RG1OWE-840M-D1500-U	RG1OSE-840M-D1500-U	4428,00
2000	4000K	On/Off	Low	15730lm/131W	20,0	RG1OWE-840E-D2000-U	RG1OSE-840E-D2000-U	6846,00
2000	4000K	On/Off	Medium	19690lm/168W	20,0	RG1OWE-840M-D2000-U	RG1OSE-840M-D2000-U	6846,00
2500	4000K	On/Off	Low	20300lm/166W	29,0	RG1OWE-840E-D2500-K	RG1OSE-840E-D2500-K	8533,00
2500	4000K	On/Off	Medium	24800lm/207W	29,0	RG1OWE-840M-D2500-K	RG1OSE-840M-D2500-K	8533,00
3000	4000K	On/Off	Low	24990lm/202W	34,0	RG1OWE-840E-D3000-K	RG1OSE-840E-D3000-K	10203,00
3000	4000K	On/Off	Medium	30520lm/252W	34,0	RG1OWE-840M-D3000-K	RG1OSE-840M-D3000-K	10203,00
3500	4000K	On/Off	Low	28110lm/227W	40,0	RG1OWE-840E-D3500-K	RG1OSE-840E-D3500-K	11501,00
3500	4000K	On/Off	Medium	34340lm/281W	40,0	RG1OWE-840M-D3500-K	RG1OSE-840M-D3500-K	11501,00
4000	4000K	On/Off	Low	32790lm/271W	46,0	RG1OWE-840E-D4000-K	RG1OSE-840E-D4000-K	13302,00
4000	4000K	On/Off	Medium	40060lm/338W	46,0	RG1OWE-840M-D4000-K	RG1OSE-840M-D4000-K	13302,00
5000	4000K	On/Off	Low	40600lm/332W	58,0	RG1OWE-840E-D5000-K	RG1OSE-840E-D5000-K	16622,00
5000	4000K	On/Off	Medium	49600lm/414W	58,0	RG1OWE-840M-D5000-K	RG1OSE-840M-D5000-K	16622,00
6000	4000K	On/Off	Low	49970lm/405W	69,0	RG1OWE-840E-D6000-K	RG1OSE-840E-D6000-K	20017,00
6000	4000K	On/Off	Medium	61050lm/504W	69,0	RG1OWE-840M-D6000-K	RG1OSE-840M-D6000-K	20017,00
7000	4000K	On/Off	Low	59340lm/496W	81,0	RG1OWE-840E-D7000-K	RG1OSE-840E-D7000-K	23263,00
7000	4000K	On/Off	Medium	72500lm/617W	81,0	RG1OWE-840M-D7000-K	RG1OSE-840M-D7000-K	23263,00
8000	4000K	On/Off	Low	66370lm/536W	92,0	RG1OWE-840E-D8000-K	RG1OSE-840E-D8000-K	26620,00
8000	4000K	On/Off	Medium	81080lm/667W	92,0	RG1OWE-840M-D8000-K	RG1OSE-840M-D8000-K	26620,00



Midpoint Spotlight XP
1000lm/19W-3000lm/31W Ø90mm

Surcharges

Surface Finish	CHF	Control Gear	CHF	CHF	CHF	Colour Rendering	CHF	Suspension Type	CHF
W: Snow White	✓	E: On/Off				8: CR1>80	✓	U: Central Suspension [D600-D2000]	✓
V: Ivory White	✓	L: DALI	+86,00	+172,00	ⓘ	9: CR1>90	+5%	K: Parallel Suspension	✓
S: Radiant Silver	✓	H: Touch-Dim	+86,00	+172,00	ⓘ	F: Full Spectrum	+15%	D: Disc Suspension [D600-D2000]	+139,00
U: Urban Graphite	✓	C: Casambi*	+261,00	+261,00	ⓘ	Colour Temperature	CHF	Additional Options	CHF
B: Jet Black	✓	6: DALI DT6 for TW	+172,00	+343,00	ⓘ	22: 2200K	+5%	Emergency Module [DALI, Autotest, incl. 3H Battery] [D1200-D2000]	+366,00
H: Anodic Champagne	+10%	8: DALI DT8 for TW [D900-D8000]	+172,00	+343,00	ⓘ	27: 2700K	+5%	Midpoint Spotlight XP	+489,00
K: Satin Copper	+15%	U: Separately Dimmable DALI	+172,00	+343,00	ⓘ	30: 3000K	✓		
R: Special RAL/NCS Colours	ⓘ					35: 3500K	+5%		
						40: 4000K	✓		
						65: 6500K	+5%		
						TW: Tunable White 2700-6500K*	+30%		

✓ standard / no extra charge ⓘ on request ✗ not available

*Only in combination with DT6, DT8 or Casambi control. Please add additional control price.

Ringo Star Acoustic G1/P1 | System 100mm Suspended

catalogue page 228



Parallel Suspension

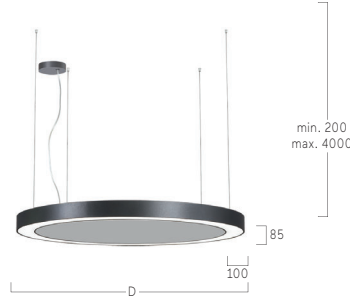

Central Suspension



Microprismatic | Direct-Indirect

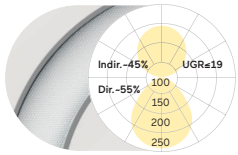

D mm	Colour Temperature	Control	Power	Lumen/Watt	Weight kg	Code Snow White	Code Radiant Silver	CHF
600	4000K	On/Off	Low	7510lm/59W	7,2	RP1AWE-840E-D600-U-AW	RP1ASE-840E-D600-U-AW	3229,00
600	4000K	On/Off	Medium	9860lm/79W	7,2	RP1AWE-840M-D600-U-AW	RP1ASE-840M-D600-U-AW	3229,00
900	4000K	On/Off	Low	12360lm/99W	14,0	RP1AWE-840E-D900-U-AW	RP1ASE-840E-D900-U-AW	4468,00
900	4000K	On/Off	Medium	16510lm/134W	14,0	RP1AWE-840M-D900-U-AW	RP1ASE-840M-D900-U-AW	4468,00
1200	4000K	On/Off	Low	16240lm/128W	21,3	RP1AWE-840E-D1200-U-AW	RP1ASE-840E-D1200-U-AW	5436,00
1200	4000K	On/Off	Medium	21930lm/174W	21,3	RP1AWE-840M-D1200-U-AW	RP1ASE-840M-D1200-U-AW	5436,00
1500	4000K	On/Off	Low	21000lm/162W	28,6	RP1AWE-840E-D1500-U-AW	RP1ASE-840E-D1500-U-AW	6701,00
1500	4000K	On/Off	Medium	27850lm/218W	28,6	RP1AWE-840M-D1500-U-AW	RP1ASE-840M-D1500-U-AW	6701,00
2000	4000K	On/Off	Low	28010lm/218W	43,7	RP1AWE-840E-D2000-U-AW	RP1ASE-840E-D2000-U-AW	11069,00
2000	4000K	On/Off	Medium	37860lm/299W	43,7	RP1AWE-840M-D2000-U-AW	RP1ASE-840M-D2000-U-AW	11069,00

Microprismatic | Direct

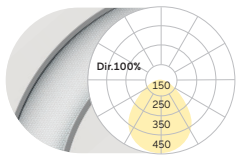

D mm	Colour Temperature	Control	Power	Lumen/Watt	Weight kg	Code Snow White	Code Radiant Silver	CHF
600	4000K	On/Off	Low	3810lm/34W	7,0	RG1AWE-840E-D600-U-AW	RG1ASE-840E-D600-U-AW	2762,00
600	4000K	On/Off	Medium	4790lm/45W	7,0	RG1AWE-840M-D600-U-AW	RG1ASE-840M-D600-U-AW	2762,00
900	4000K	On/Off	Low	6460lm/59W	13,4	RG1AWE-840E-D900-U-AW	RG1ASE-840E-D900-U-AW	3765,00
900	4000K	On/Off	Medium	7900lm/75W	13,4	RG1AWE-840M-D900-U-AW	RG1ASE-840M-D900-U-AW	3765,00
1200	4000K	On/Off	Low	8750lm/79W	19,4	RG1AWE-840E-D1200-U-AW	RG1ASE-840E-D1200-U-AW	5021,00
1200	4000K	On/Off	Medium	10260lm/95W	19,4	RG1AWE-840M-D1200-U-AW	RG1ASE-840M-D1200-U-AW	5021,00
1500	4000K	On/Off	Low	10980lm/98W	28,2	RG1AWE-840E-D1500-U-AW	RG1ASE-840E-D1500-U-AW	6124,00
1500	4000K	On/Off	Medium	13200lm/120W	28,2	RG1AWE-840M-D1500-U-AW	RG1ASE-840M-D1500-U-AW	6124,00
2000	4000K	On/Off	Low	14650lm/131W	45,0	RG1AWE-840E-D2000-U-AW	RG1ASE-840E-D2000-U-AW	9585,00
2000	4000K	On/Off	Medium	18330lm/168W	45,0	RG1AWE-840M-D2000-U-AW	RG1ASE-840M-D2000-U-AW	9585,00

Opal Diffuser | Direct-Indirect

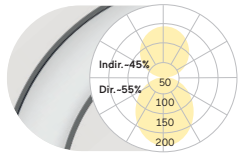

D mm	Colour Temperature	Control	Power	Lumen/Watt	Weight kg	Code Snow White	Code Radiant Silver	CHF
600	4000K	On/Off	Low	7790lm/59W	7,2	RP1OWE-840E-D600-U-AW	RP1OSE-840E-D600-U-AW	3140,00
600	4000K	On/Off	Medium	10220lm/79W	7,2	RP1OWE-840M-D600-U-AW	RP1OSE-840M-D600-U-AW	3140,00
900	4000K	On/Off	Low	12830lm/99W	14,0	RP1OWE-840E-D900-U-AW	RP1OSE-840E-D900-U-AW	3588,00
900	4000K	On/Off	Medium	17100lm/134W	14,0	RP1OWE-840M-D900-U-AW	RP1OSE-840M-D900-U-AW	4288,00
1200	4000K	On/Off	Low	16890lm/128W	21,3	RP1OWE-840E-D1200-U-AW	RP1OSE-840E-D1200-U-AW	5166,00
1200	4000K	On/Off	Medium	22700lm/174W	21,3	RP1OWE-840M-D1200-U-AW	RP1OSE-840M-D1200-U-AW	5166,00
1500	4000K	On/Off	Low	21820lm/162W	28,6	RP1OWE-840E-D1500-U-AW	RP1OSE-840E-D1500-U-AW	6316,00
1500	4000K	On/Off	Medium	28830lm/218W	28,6	RP1OWE-840M-D1500-U-AW	RP1OSE-840M-D1500-U-AW	6316,00
2000	4000K	On/Off	Low	29090lm/218W	43,7	RP1OWE-840E-D2000-U-AW	RP1OSE-840E-D2000-U-AW	10605,00
2000	4000K	On/Off	Medium	39220lm/299W	43,7	RP1OWE-840M-D2000-U-AW	RP1OSE-840M-D2000-U-AW	10605,00

Opal Diffuser | Direct

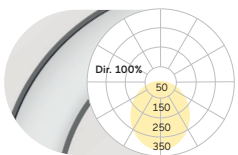

D mm	Colour Temperature	Control	Power	Lumen/Watt	Weight kg	Code Snow White	Code Radiant Silver	CHF
600	4000K	On/Off	Low	4090lm/34W	7,0	RG1OWE-840E-D600-U-AW	RG1OSE-840E-D600-U-AW	2671,00
600	4000K	On/Off	Medium	5150lm/45W	7,0	RG1OWE-840M-D600-U-AW	RG1OSE-840M-D600-U-AW	2671,00
900	4000K	On/Off	Low	6930lm/59W	13,4	RG1OWE-840E-D900-U-AW	RG1OSE-840E-D900-U-AW	3584,00
900	4000K	On/Off	Medium	8490lm/75W	13,4	RG1OWE-840M-D900-U-AW	RG1OSE-840M-D900-U-AW	3584,00
1200	4000K	On/Off	Low	9400lm/79W	19,4	RG1OWE-840E-D1200-U-AW	RG1OSE-840E-D1200-U-AW	4752,00
1200	4000K	On/Off	Medium	11030lm/95W	19,4	RG1OWE-840M-D1200-U-AW	RG1OSE-840M-D1200-U-AW	4752,00
1500	4000K	On/Off	Low	11800lm/98W	28,2	RG1OWE-840E-D1500-U-AW	RG1OSE-840E-D1500-U-AW	5739,00
1500	4000K	On/Off	Medium	14180lm/120W	28,2	RG1OWE-840M-D1500-U-AW	RG1OSE-840M-D1500-U-AW	5739,00
2000	4000K	On/Off	Low	15730lm/131W	45,0	RG1OWE-840E-D2000-U-AW	RG1OSE-840E-D2000-U-AW	9121,00
2000	4000K	On/Off	Medium	19690lm/168W	45,0	RG1OWE-840M-D2000-U-AW	RG1OSE-840M-D2000-U-AW	9121,00



AW Micro Perforated

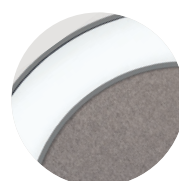

BW: Beige Wool

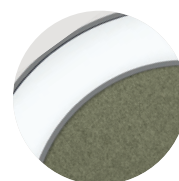

ZW: Green Wool

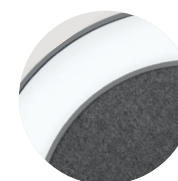

GW: Graphite Wool

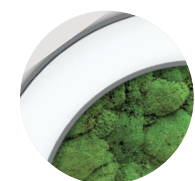

AM Green Moss

Surcharges

Surface Finish	CHF	Control Gear	CHF	CHF	Colour Rendering	CHF	Suspension Type	CHF
W: Snow White	✓	E: On/Off	✓	✓	8: CRI>80	✓	U: Central Suspension [D600-D2000]	✓
V: Ivory White	✓	L: DALI	+86,00	+172,00	9: CRI>90	+5%	K: Parallel Suspension	✓
S: Radiant Silver	✓	H: Touch-Dim	+86,00	+172,00	F: Full Spectrum	+15%	D: Disc Suspension [D600-D2000]	✓
U: Urban Graphite	✓	C: Casambi*	+261,00	+261,00	Colour Temperature	CHF	Acoustic Absorber	CHF
B: Jet Black	✓	6: DALI DT6 for TW	+172,00	+343,00	22: 2200K	+5%	AW: Micro Perforated	✓
H: Anodic Champagne	+10%	8: DALI DT8 for TW [D900-D2000]	+172,00	+343,00	27: 2700K	+5%	BW: Beige Wool [D600-D1500]	+5%
K: Satin Copper	+15%	U: Separately Dimmable DALI	+172,00	+343,00	30: 3000K	✓	ZW: Green Wool [D600-D1500]	+5%
R: Special RAL/NCS Colours	🕒	*Only in combination with DALI Please add to dimming price.			35: 3500K	+5%	GW: Graphite Wool [D600-D1500]	+5%
					40: 4000K	✓	AM: Green Moss	🕒
					65: 6500K	+5%	Additional Options	CHF
					TW: Tunable White 2700-6500K*	+30%	Emergency Module [D1200-D2000]	+296,00
							*Only in combination with DT6, DT8 or Casambi control. Please add additional control price.	

✓ standard / no extra charge 🕒 on request ✗ not available

Ringo Star Chandelier G1/P1 | Suspended

catalogue page 232

Parallel Suspension

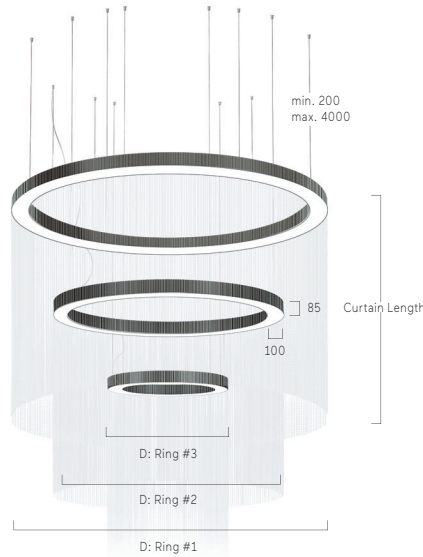

Opal Diffuser | Direct-Indirect

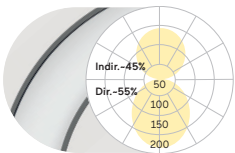

Ring Arrangement	Curtain Length	Colour	Control	Power	Weight	Code	Code	CHF
Ring#1+Ring#2+Ring#3	mm	Temperature			kg	Snow White	Radiant Silver	
D1500+D900+D600	Without Curtain	4000K	On/Off	Low	36,5	RP1OWE-840E-CH421-K	RP1OSE-840E-CH421-K	11200,00
D1500+D900+D600	Without Curtain	4000K	On/Off	Medium	36,5	RP1OWE-840M-CH421-K	RP1OSE-840M-CH421-K	11200,00
D2000+D1500+D1200	Without Curtain	4000K	On/Off	Low	54,0	RP1OWE-840E-CH543-K	RP1OSE-840E-CH543-K	17623,00
D2000+D1500+D1200	Without Curtain	4000K	On/Off	Medium	54,0	RP1OWE-840M-CH543-K	RP1OSE-840M-CH543-K	17623,00

Ring Arrangement	Curtain Length	Colour	Control	Power	Weight	Code	Code	CHF
Ring#1+Ring#2+Ring#3	mm	Temperature			kg	Snow White	Radiant Silver	
D1500+D900+D600	1500	4000K	On/Off	Low	42,5	RP1OWE-840E-CW421-1500-K	RP1OSE-840E-CW421-1500-K	19040,00
D1500+D900+D600	1500	4000K	On/Off	Medium	42,5	RP1OWE-840M-CW421-1500-K	RP1OSE-840M-CW421-1500-K	19040,00
D2000+D1500+D1200	1500	4000K	On/Off	Low	63,3	RP1OWE-840E-CW543-1500-K	RP1OSE-840E-CW543-1500-K	29960,00
D2000+D1500+D1200	1500	4000K	On/Off	Medium	63,3	RP1OWE-840M-CW543-1500-K	RP1OSE-840M-CW543-1500-K	29960,00

Ring Arrangement	Curtain Length	Colour	Control	Power	Weight	Code	Code	CHF
Ring#1+Ring#2+Ring#3	mm	Temperature			kg	Snow White	Radiant Silver	
D1500+D900+D600	3000	4000K	On/Off	Low	47,0	RP1OWE-840E-CW421-3000-K	RP1OSE-840E-CW421-3000-K	19040,00
D1500+D900+D600	3000	4000K	On/Off	Medium	47,0	RP1OWE-840M-CW421-3000-K	RP1OSE-840M-CW421-3000-K	19040,00
D2000+D1500+D1200	3000	4000K	On/Off	Low	71,0	RP1OWE-840E-CW543-3000-K	RP1OSE-840E-CW543-3000-K	29960,00
D2000+D1500+D1200	3000	4000K	On/Off	Medium	71,0	RP1OWE-840M-CW543-3000-K	RP1OSE-840M-CW543-3000-K	29960,00

Ring Arrangement	Curtain Length	Colour	Control	Power	Weight	Code	Code	CHF
Ring#1+Ring#2+Ring#3	mm	Temperature			kg	Snow White	Radiant Silver	
D1500+D900+D600	5000	4000K	On/Off	Low	51,5	RP1OWE-840E-CW421-5000-K	RP1OSE-840E-CW421-5000-K	24640,00
D1500+D900+D600	5000	4000K	On/Off	Medium	51,5	RP1OWE-840M-CW421-5000-K	RP1OSE-840M-CW421-5000-K	24640,00
D2000+D1500+D1200	5000	4000K	On/Off	Low	79,5	RP1OWE-840E-CW543-5000-K	RP1OSE-840E-CW543-5000-K	38780,00
D2000+D1500+D1200	5000	4000K	On/Off	Medium	79,5	RP1OWE-840M-CW543-5000-K	RP1OSE-840M-CW543-5000-K	38780,00

... Ringo Star Chandelier G1/P1 | Suspended

Opal Diffuser | Direct

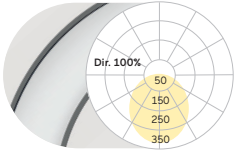

Ring Arrangement Ring#1+Ring#2+Ring#3	Curtain Length mm	Colour Temperature	Control	Power	Weight kg	Code Snow White	Code Radiant Silver	CHF
D1500+D900+D600	Without Curtain	4000K	On/Off	Low	33,0	RG1OWE-840E-CH421-K	RG1OSE-840E-CH421-K	10114,00
D1500+D900+D600	Without Curtain	4000K	On/Off	Medium	33,0	RG1OWE-840M-CH421-K	RG1OSE-840M-CH421-K	10114,00
D2000+D1500+D1200	Without Curtain	4000K	On/Off	Low	50,0	RG1OWE-840E-CH543-K	RG1OSE-840E-CH543-K	16268,00
D2000+D1500+D1200	Without Curtain	4000K	On/Off	Medium	50,0	RG1OWE-840M-CH543-K	RG1OSE-840M-CH543-K	16268,00

Ring Arrangement Ring#1+Ring#2+Ring#3	Curtain Length mm	Colour Temperature	Control	Power	Weight kg	Code Snow White	Code Radiant Silver	CHF
D1500+D900+D600	1500	4000K	On/Off	Low	39,0	RG1OWE-840E-CW421-1500-K	RG1OSE-840E-CW421-1500-K	17194,00
D1500+D900+D600	1500	4000K	On/Off	Medium	39,0	RG1OWE-840M-CW421-1500-K	RG1OSE-840M-CW421-1500-K	17194,00
D2000+D1500+D1200	1500	4000K	On/Off	Low	59,3	RG1OWE-840E-CW543-1500-K	RG1OSE-840E-CW543-1500-K	27656,00
D2000+D1500+D1200	1500	4000K	On/Off	Medium	59,3	RG1OWE-840M-CW543-1500-K	RG1OSE-840M-CW543-1500-K	27656,00

Ring Arrangement Ring#1+Ring#2+Ring#3	Curtain Length mm	Colour Temperature	Control	Power	Weight kg	Code Snow White	Code Radiant Silver	CHF
D1500+D900+D600	3000	4000K	On/Off	Low	43,5	RG1OWE-840E-CW421-3000-K	RG1OSE-840E-CW421-3000-K	17194,00
D1500+D900+D600	3000	4000K	On/Off	Medium	43,5	RG1OWE-840M-CW421-3000-K	RG1OSE-840M-CW421-3000-K	17194,00
D2000+D1500+D1200	3000	4000K	On/Off	Low	67,0	RG1OWE-840E-CW543-3000-K	RG1OSE-840E-CW543-3000-K	27656,00
D2000+D1500+D1200	3000	4000K	On/Off	Medium	67,0	RG1OWE-840M-CW543-3000-K	RG1OSE-840M-CW543-3000-K	27656,00

Ring Arrangement Ring#1+Ring#2+Ring#3	Curtain Length mm	Colour Temperature	Control	Power	Weight kg	Code Snow White	Code Radiant Silver	CHF
D1500+D900+D600	5000	4000K	On/Off	Low	48,0	RG1OWE-840E-CW421-5000-K	RG1OSE-840E-CW421-5000-K	22252,00
D1500+D900+D600	5000	4000K	On/Off	Medium	48,0	RG1OWE-840M-CW421-5000-K	RG1OSE-840M-CW421-5000-K	22252,00
D2000+D1500+D1200	5000	4000K	On/Off	Low	75,5	RG1OWE-840E-CW543-5000-K	RG1OSE-840E-CW543-5000-K	35788,00
D2000+D1500+D1200	5000	4000K	On/Off	Medium	75,5	RG1OWE-840M-CW543-5000-K	RG1OSE-840M-CW543-5000-K	35788,00

Surcharges

Surface Finish CHF	Control Gear CHF	Colour Rendering CHF	Colour Temperature CHF	Curtain Colour CHF
W: Snow White ✓	E: On/Off ✓	8: CRI>80 ✓	22: 2200K +5%	CH: Chandelier (without curtain) ✓
V: Ivory White ✓	H: Touch-Dim ⚠	9: CRI>90 +5%	27: 2700K +5%	CW: White ✓
S: Radiant Silver ✓	L: DALI ⚠	F: Full Spectrum +15%	30: 3000K ✓	CB: Black ✓
U: Urban Graphite ✓	G: DALI DT6 for TW ⚠		35: 3500K +5%	Additional Options CHF
B: Jet Black ✓	8: DALI DT8 for TW ⚠		40: 4000K ✓	Central Suspension ⚠
H: Anodic Champagne +10%	[D900-D4000] ⚠		65: 6500K +5%	
K: Satin Copper +15%	C: Casambi** ⚠		TW: Tunable White 2700-6500K* +30%	
R: Special RAL/NCS Colours ⚠	**Only in combination with DALI Please add to dimming price.		*Only in combination with DT6, DT8 or Casambi control. Please add additional control price.	

✓ standard / no extra charge
 ⚠ on request
 ✗ not available

Ringo Star Chandelier Single G1/P1 | Suspended

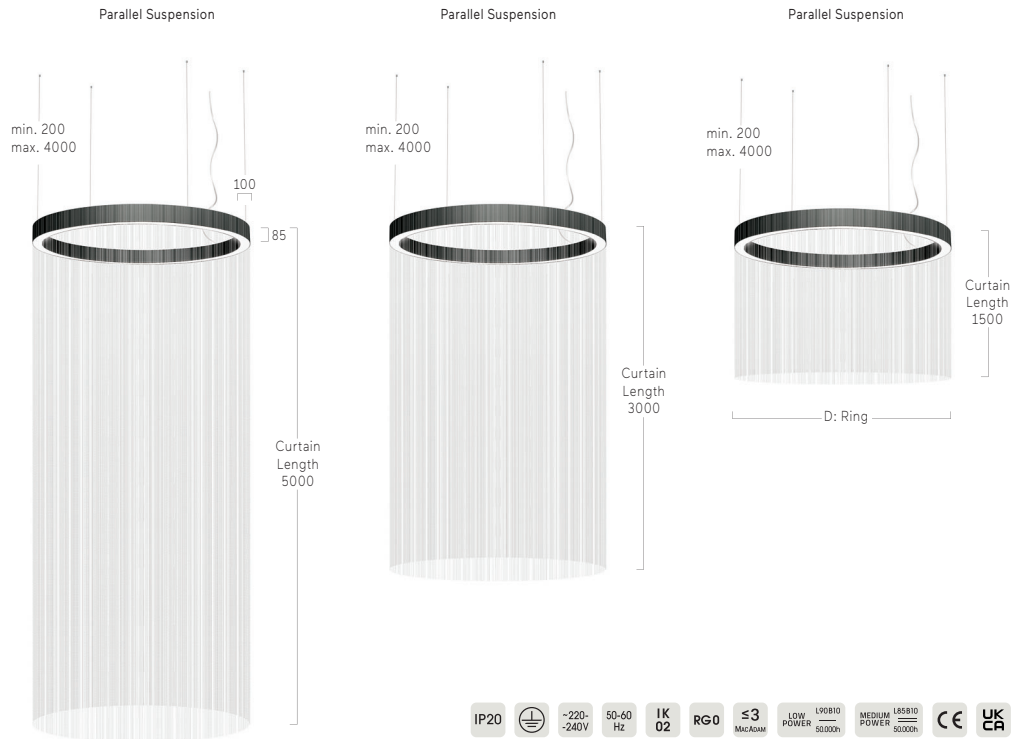

Opal Diffuser | Direct-Indirect

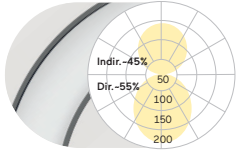

D mm	Curtain Length mm	Colour Temp.	Control	Power	Lumen/Watt	Weight kg	Code Snow White	Code Radiant Silver	CHF
600	1500	4000K	On/Off	Low	7790lm/59W	8,5	RP1OWE-840E-CWD600-1500-K	RP1OSE-840E-CWD600-1500-K	5184,00
600	1500	4000K	On/Off	Medium	10220lm/79W	8,5	RP1OWE-840M-CWD600-1500-K	RP1OSE-840M-CWD600-1500-K	5184,00
600	3000	4000K	On/Off	Low	7790lm/59W	9,5	RP1OWE-840E-CWD600-3000-K	RP1OSE-840E-CWD600-3000-K	5184,00
600	3000	4000K	On/Off	Medium	10220lm/79W	9,5	RP1OWE-840M-CWD600-3000-K	RP1OSE-840M-CWD600-3000-K	5184,00
600	5000	4000K	On/Off	Low	7790lm/59W	10,8	RP1OWE-840E-CWD600-5000-K	RP1OSE-840E-CWD600-5000-K	6986,00
600	5000	4000K	On/Off	Medium	10220lm/79W	10,8	RP1OWE-840M-CWD600-5000-K	RP1OSE-840M-CWD600-5000-K	6986,00
900	1500	4000K	On/Off	Low	12830lm/99W	12,8	RP1OWE-840E-CWD900-1500-K	RP1OSE-840E-CWD900-1500-K	6157,00
900	1500	4000K	On/Off	Medium	17100lm/134W	12,8	RP1OWE-840M-CWD900-1500-K	RP1OSE-840M-CWD900-1500-K	6157,00
900	3000	4000K	On/Off	Low	12830lm/99W	14,1	RP1OWE-840E-CWD900-3000-K	RP1OSE-840E-CWD900-3000-K	6157,00
900	3000	4000K	On/Off	Medium	17100lm/134W	14,1	RP1OWE-840M-CWD900-3000-K	RP1OSE-840M-CWD900-3000-K	6157,00
900	5000	4000K	On/Off	Low	12830lm/99W	16,0	RP1OWE-840E-CWD900-5000-K	RP1OSE-840E-CWD900-5000-K	7959,00
900	5000	4000K	On/Off	Medium	17100lm/134W	16,0	RP1OWE-840M-CWD900-5000-K	RP1OSE-840M-CWD900-5000-K	7959,00
1200	1500	4000K	On/Off	Low	16890lm/128W	16,2	RP1OWE-840E-CWD1200-1500-K	RP1OSE-840E-CWD1200-1500-K	8145,00
1200	1500	4000K	On/Off	Medium	22700lm/174W	16,2	RP1OWE-840M-CWD1200-1500-K	RP1OSE-840M-CWD1200-1500-K	8145,00
1200	3000	4000K	On/Off	Low	16890lm/128W	18,1	RP1OWE-840E-CWD1200-3000-K	RP1OSE-840E-CWD1200-3000-K	8145,00
1200	3000	4000K	On/Off	Medium	22700lm/174W	18,1	RP1OWE-840M-CWD1200-3000-K	RP1OSE-840M-CWD1200-3000-K	8145,00
1200	5000	4000K	On/Off	Low	16890lm/128W	20,6	RP1OWE-840E-CWD1200-5000-K	RP1OSE-840E-CWD1200-5000-K	10849,00
1200	5000	4000K	On/Off	Medium	22700lm/174W	20,6	RP1OWE-840M-CWD1200-5000-K	RP1OSE-840M-CWD1200-5000-K	10849,00
1500	1500	4000K	On/Off	Low	21820lm/162W	20,7	RP1OWE-840E-CWD1500-1500-K	RP1OSE-840E-CWD1500-1500-K	10143,00
1500	1500	4000K	On/Off	Medium	28830lm/218W	20,7	RP1OWE-840M-CWD1500-1500-K	RP1OSE-840M-CWD1500-1500-K	10143,00
1500	3000	4000K	On/Off	Low	21820lm/162W	23,1	RP1OWE-840E-CWD1500-3000-K	RP1OSE-840E-CWD1500-3000-K	10143,00
1500	3000	4000K	On/Off	Medium	28830lm/218W	23,1	RP1OWE-840M-CWD1500-3000-K	RP1OSE-840M-CWD1500-3000-K	10143,00
1500	5000	4000K	On/Off	Low	21820lm/162W	26,3	RP1OWE-840E-CWD1500-5000-K	RP1OSE-840E-CWD1500-5000-K	13748,00
1500	5000	4000K	On/Off	Medium	28830lm/218W	26,3	RP1OWE-840M-CWD1500-5000-K	RP1OSE-840M-CWD1500-5000-K	13748,00
2000	1500	4000K	On/Off	Low	29090lm/218W	25,5	RP1OWE-840E-CWD2000-1500-K	RP1OSE-840E-CWD2000-1500-K	14753,00
2000	1500	4000K	On/Off	Medium	39220lm/299W	25,5	RP1OWE-840M-CWD2000-1500-K	RP1OSE-840M-CWD2000-1500-K	14753,00
2000	3000	4000K	On/Off	Low	29090lm/218W	28,7	RP1OWE-840E-CWD2000-3000-K	RP1OSE-840E-CWD2000-3000-K	14753,00
2000	3000	4000K	On/Off	Medium	39220lm/299W	28,7	RP1OWE-840M-CWD2000-3000-K	RP1OSE-840M-CWD2000-3000-K	14753,00
2000	5000	4000K	On/Off	Low	29090lm/218W	32,8	RP1OWE-840E-CWD2000-5000-K	RP1OSE-840E-CWD2000-5000-K	19259,00
2000	5000	4000K	On/Off	Medium	39220lm/299W	32,8	RP1OWE-840M-CWD2000-5000-K	RP1OSE-840M-CWD2000-5000-K	19259,00

Opal Diffuser | Direct

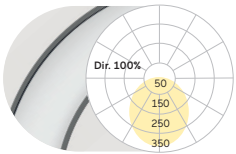

D mm	Curtain Length mm	Colour Temp.	Control	Power	Lumen/Watt	Weight kg	Code Snow White	Code Radiant Silver	CHF
600	1500	4000K	On/Off	Low	4090lm/34W	7,1	RG1OWE-840E-CWD600-1500-K	RG1OSE-840E-CWD600-1500-K	4715,00
600	1500	4000K	On/Off	Medium	5150lm/45W	7,1	RG1OWE-840M-CWD600-1500-K	RG1OSE-840M-CWD600-1500-K	4715,00
600	3000	4000K	On/Off	Low	4090lm/34W	8,1	RG1OWE-840E-CWD600-3000-K	RG1OSE-840E-CWD600-3000-K	4715,00
600	3000	4000K	On/Off	Medium	5150lm/45W	8,1	RG1OWE-840M-CWD600-3000-K	RG1OSE-840M-CWD600-3000-K	4715,00
600	5000	4000K	On/Off	Low	4090lm/34W	9,4	RG1OWE-840E-CWD600-5000-K	RG1OSE-840E-CWD600-5000-K	6517,00
600	5000	4000K	On/Off	Medium	5150lm/45W	9,4	RG1OWE-840M-CWD600-5000-K	RG1OSE-840M-CWD600-5000-K	6517,00
900	1500	4000K	On/Off	Low	6930lm/59W	11,8	RG1OWE-840E-CWD900-1500-K	RG1OSE-840E-CWD900-1500-K	5453,00
900	1500	4000K	On/Off	Medium	8490lm/75W	11,8	RG1OWE-840M-CWD900-1500-K	RG1OSE-840M-CWD900-1500-K	5453,00
900	3000	4000K	On/Off	Low	6930lm/59W	13,1	RG1OWE-840E-CWD900-3000-K	RG1OSE-840E-CWD900-3000-K	5453,00
900	3000	4000K	On/Off	Medium	8490lm/75W	13,1	RG1OWE-840M-CWD900-3000-K	RG1OSE-840M-CWD900-3000-K	5453,00
900	5000	4000K	On/Off	Low	6930lm/59W	15,0	RG1OWE-840E-CWD900-5000-K	RG1OSE-840E-CWD900-5000-K	7256,00
900	5000	4000K	On/Off	Medium	8490lm/75W	15,0	RG1OWE-840M-CWD900-5000-K	RG1OSE-840M-CWD900-5000-K	7256,00
1200	1500	4000K	On/Off	Low	9400lm/79W	15,2	RG1OWE-840E-CWD1200-1500-K	RG1OSE-840E-CWD1200-1500-K	7730,00
1200	1500	4000K	On/Off	Medium	11030lm/95W	15,2	RG1OWE-840M-CWD1200-1500-K	RG1OSE-840M-CWD1200-1500-K	7730,00
1200	3000	4000K	On/Off	Low	9400lm/79W	17,1	RG1OWE-840E-CWD1200-3000-K	RG1OSE-840E-CWD1200-3000-K	7730,00
1200	3000	4000K	On/Off	Medium	11030lm/95W	17,1	RG1OWE-840M-CWD1200-3000-K	RG1OSE-840M-CWD1200-3000-K	7730,00
1200	5000	4000K	On/Off	Low	9400lm/79W	19,6	RG1OWE-840E-CWD1200-5000-K	RG1OSE-840E-CWD1200-5000-K	10434,00
1200	5000	4000K	On/Off	Medium	11030lm/95W	19,6	RG1OWE-840M-CWD1200-5000-K	RG1OSE-840M-CWD1200-5000-K	10434,00
1500	1500	4000K	On/Off	Low	11800lm/98W	19,7	RG1OWE-840E-CWD1500-1500-K	RG1OSE-840E-CWD1500-1500-K	9566,00
1500	1500	4000K	On/Off	Medium	14180lm/120W	19,7	RG1OWE-840M-CWD1500-1500-K	RG1OSE-840M-CWD1500-1500-K	9566,00
1500	3000	4000K	On/Off	Low	11800lm/98W	22,1	RG1OWE-840E-CWD1500-3000-K	RG1OSE-840E-CWD1500-3000-K	9566,00
1500	3000	4000K	On/Off	Medium	14180lm/120W	22,1	RG1OWE-840M-CWD1500-3000-K	RG1OSE-840M-CWD1500-3000-K	9566,00
1500	5000	4000K	On/Off	Low	11800lm/98W	25,3	RG1OWE-840E-CWD1500-5000-K	RG1OSE-840E-CWD1500-5000-K	13171,00
1500	5000	4000K	On/Off	Medium	14180lm/120W	25,3	RG1OWE-840M-CWD1500-5000-K	RG1OSE-840M-CWD1500-5000-K	13171,00
2000	1500	4000K	On/Off	Low	15730lm/131W	23,5	RG1OWE-840E-CWD2000-1500-K	RG1OSE-840E-CWD2000-1500-K	13269,00
2000	1500	4000K	On/Off	Medium	19690lm/168W	23,5	RG1OWE-840M-CWD2000-1500-K	RG1OSE-840M-CWD2000-1500-K	13269,00
2000	3000	4000K	On/Off	Low	15730lm/131W	26,7	RG1OWE-840E-CWD2000-3000-K	RG1OSE-840E-CWD2000-3000-K	13269,00
2000	3000	4000K	On/Off	Medium	19690lm/168W	26,7	RG1OWE-840M-CWD2000-3000-K	RG1OSE-840M-CWD2000-3000-K	13269,00
2000	5000	4000K	On/Off	Low	15730lm/131W	30,8	RG1OWE-840E-CWD2000-5000-K	RG1OSE-840E-CWD2000-5000-K	17775,00
2000	5000	4000K	On/Off	Medium	19690lm/168W	30,8	RG1OWE-840M-CWD2000-5000-K	RG1OSE-840M-CWD2000-5000-K	17775,00

Surcharges

Surface Finish	CHF	Control Gear	CHF	Colour Rendering	CHF	Colour Temperature	CHF	Curtain Colour	CHF
W: Snow White	✓	E: On/Off	✓	8: CRI>80	✓	22: 2200K	+5%	CW: White	✓
V: Ivory White	✓	H: Touch-Dim	ⓘ	9: CRI>90	+5%	27: 2700K	+5%	CB: Black	✓
S: Radiant Silver	✓	L: DALI	ⓘ	F: Full Spectrum	+15%	30: 3000K	✓	Additional Options CHF	
U: Urban Graphite	✓	G: DALI DT6 for TW	ⓘ			35: 3500K	+5%	Central Suspension	ⓘ
B: Jet Black	✓	8: DALI DT8 for TW [D900-D4000]	ⓘ			40: 4000K	✓		
H: Anodic Champagne	+10%	C: Casambi**	ⓘ			65: 6500K	+5%		
K: Satin Copper	+15%					TW: Tunable White 2700-6500K*	+30%		
R: Special RAL/NCS Colours	ⓘ	**Only in combination with DALI Please add to dimming price.				*Only in combination with DT6, DT8 or Casambi control. Please add additional control price.			

✓ standard / no extra charge ⓘ on request ✗ not available

Ringo Star Cluster G3/P3 | Suspended

catalogue page 240

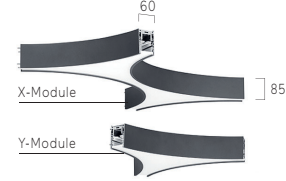
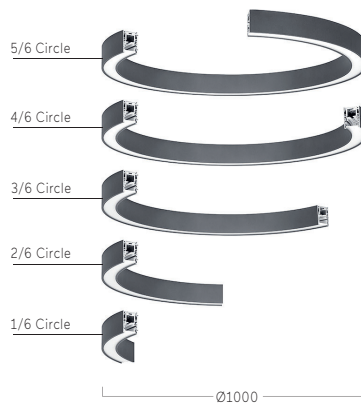

Opal Diffuser | Direct-Indirect

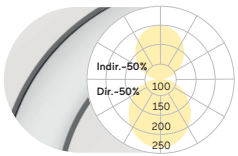

Light Distribution	Module Type	Colour Temp.	Control	Power	Lumen/Watt	Weight kg	Code Snow White	Code Radiant Silver	CHF
Opal Direct-Indirect	C1	4000K	On/Off	Low	920lm/11W	1,8	RP30WE-840E-C1-K	RP30SE-840E-C1-K	709,00
Opal Direct-Indirect	C1	4000K	On/Off	Medium	1330lm/16W	1,8	RP30WE-840M-C1-K	RP30SE-840M-C1-K	709,00
Opal Direct only	C1	4000K	On/Off	Low	650lm/8W	1,8	RG30WE-840E-C1-K	RG30SE-840E-C1-K	599,00
Opal Direct only	C1	4000K	On/Off	Medium	950lm/12W	1,8	RG30WE-840M-C1-K	RG30SE-840M-C1-K	599,00

Opal Diffuser | Direct

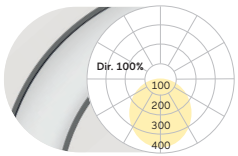

Opal Direct-Indirect	C2	4000K	On/Off	Low	2520lm/24W	3,7	RP30WE-840E-C2-K	RP30SE-840E-C2-K	1416,00
Opal Direct-Indirect	C2	4000K	On/Off	Medium	3570lm/34W	3,7	RP30WE-840M-C2-K	RP30SE-840M-C2-K	1416,00
Opal Direct only	C2	4000K	On/Off	Low	1310lm/16W	3,7	RG30WE-840E-C2-K	RG30SE-840E-C2-K	1196,00
Opal Direct only	C2	4000K	On/Off	Medium	1910lm/23W	3,7	RG30WE-840M-C2-K	RG30SE-840M-C2-K	1196,00



Opal Direct-Indirect	C3	4000K	On/Off	Low	3840lm/35W	5,5	RP30WE-840E-C3-K	RP30SE-840E-C3-K	2086,00
Opal Direct-Indirect	C3	4000K	On/Off	Medium	5450lm/50W	5,5	RP30WE-840M-C3-K	RP30SE-840M-C3-K	2086,00
Opal Direct only	C3	4000K	On/Off	Low	1910lm/22W	5,5	RG30WE-840E-C3-K	RG30SE-840E-C3-K	1747,00
Opal Direct only	C3	4000K	On/Off	Medium	2790lm/32W	5,5	RG30WE-840M-C3-K	RG30SE-840M-C3-K	1747,00



Opal Direct-Indirect	C4	4000K	On/Off	Low	5270lm/46W	7,3	RP30WE-840E-C4-K	RP30SE-840E-C4-K	2757,00
Opal Direct-Indirect	C4	4000K	On/Off	Medium	7610lm/70W	7,3	RP30WE-840M-C4-K	RP30SE-840M-C4-K	2757,00
Opal Direct only	C4	4000K	On/Off	Low	2610lm/29W	7,3	RG30WE-840E-C4-K	RG30SE-840E-C4-K	2316,00
Opal Direct only	C4	4000K	On/Off	Medium	3820lm/45W	7,3	RG30WE-840M-C4-K	RG30SE-840M-C4-K	2316,00



Opal Direct-Indirect	C5	4000K	On/Off	Low	6710lm/57W	9,2	RP30WE-840E-C5-K	RP30SE-840E-C5-K	3413,00
Opal Direct-Indirect	C5	4000K	On/Off	Medium	9700lm/86W	9,2	RP30WE-840M-C5-K	RP30SE-840M-C5-K	3413,00
Opal Direct only	C5	4000K	On/Off	Low	3260lm/36W	9,2	RG30WE-840E-C5-K	RG30SE-840E-C5-K	2895,00
Opal Direct only	C5	4000K	On/Off	Medium	4770lm/55W	9,2	RG30WE-840M-C5-K	RG30SE-840M-C5-K	2895,00



Opal Direct-Indirect	X	4000K	On/Off	Low	5520lm/55W	9,7	RP30WE-840E-X-K	RP30SE-840E-X-K	2757,00
Opal Direct-Indirect	X	4000K	On/Off	Medium	8020lm/81W	9,7	RP30WE-840M-X-K	RP30SE-840M-X-K	2757,00
Opal Direct only	X	4000K	On/Off	Low	3920lm/44W	9,7	RG30WE-840E-X-K	RG30SE-840E-X-K	2389,00
Opal Direct only	X	4000K	On/Off	Medium	5740lm/66W	9,7	RG30WE-840M-X-K	RG30SE-840M-X-K	2389,00



Opal Direct-Indirect	Y	4000K	On/Off	Low	2760lm/28W	4,8	RP30WE-840E-Y-K	RP30SE-840E-Y-K	1379,00
Opal Direct-Indirect	Y	4000K	On/Off	Medium	4010lm/41W	4,8	RP30WE-840M-Y-K	RP30SE-840M-Y-K	1379,00
Opal Direct only	Y	4000K	On/Off	Low	1960lm/22W	4,8	RG30WE-840E-Y-K	RG30SE-840E-Y-K	1196,00
Opal Direct only	Y	4000K	On/Off	Medium	2870lm/33W	4,8	RG30WE-840M-Y-K	RG30SE-840M-Y-K	1196,00



AW Micro Perforated

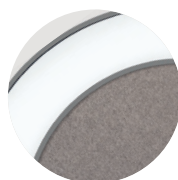

BW: Beige Wool

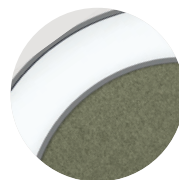

ZW: Green Wool

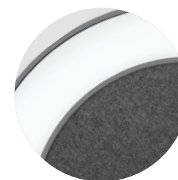

GW: Graphite Wool

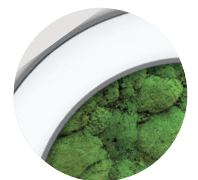

AM Green Moss

Surcharges

Surface Finish	CHF	Control Gear	CHF	Colour Rendering	CHF	Colour Temperature	CHF	Additional Options	CHF
W: Snow White	✓	E: On/Off	✓	8: CRI>80	✓	22: 2200K	+5%	Acoustic Absorber	ⓘ
V: Ivory White	✓	L: DALI	+86,00	9: CRI>90	+5%	27: 2700K	+5%		
S: Radiant Silver	✓	H: Touch-Dim	+86,00	F: Full Spectrum	+15%	30: 3000K	✓		
U: Urban Graphite	✓	C: Casambi*	+261,00			35: 3500K	+5%		
B: Jet Black	✓	U: Separately Dimmable DALI	+86,00			40: 4000K	✓		
H: Anodic Champagne	+10%					65: 6500K	+5%		
K: Satin Copper	+15%								
R: Special RAL/NCS Colours	ⓘ								

*Only in combination with DALI. Please add to dimming price.

✓ standard / no extra charge ⓘ on request ✗ not available

Ringo Star Chain G3/P3 | Suspended

catalogue page 242

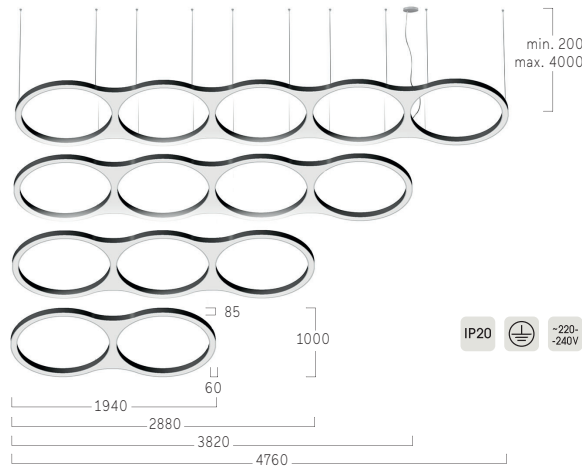

Opal Diffuser | Direct-Indirect

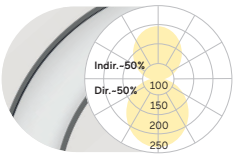

Chain Type	L mm	Colour Temperature	Control	Power	Lumen/Watt	Weight kg	Code Snow White	Code Radiant Silver	CHF
2 Rings	1940	4000K	On/Off	Low	16060lm/146W	32,0	RP3OWE-840E-2R-K	RP3OSE-840E-2R-K	8260,00
2 Rings	1940	4000K	On/Off	Medium	23240lm/218W	32,0	RP3OWE-840M-2R-K	RP3OSE-840M-2R-K	8260,00
3 Rings	2880	4000K	On/Off	Low	23420lm/209W	47,3	RP3OWE-840E-3R-K	RP3OSE-840E-3R-K	12403,00
3 Rings	2880	4000K	On/Off	Medium	33920lm/326W	47,3	RP3OWE-840M-3R-K	RP3OSE-840M-3R-K	12403,00
4 Rings	3820	4000K	On/Off	Low	30780lm/272W	62,5	RP3OWE-840E-4R-K	RP3OSE-840E-4R-K	16447,00
4 Rings	3820	4000K	On/Off	Medium	44600lm/434W	62,5	RP3OWE-840M-4R-K	RP3OSE-840M-4R-K	16447,00
5 Rings	4760	4000K	On/Off	Low	38140lm/333W	77,8	RP3OWE-840E-5R-K	RP3OSE-840E-5R-K	20489,00
5 Rings	4760	4000K	On/Off	Medium	55280lm/540W	77,8	RP3OWE-840M-5R-K	RP3OSE-840M-5R-K	20489,00

Opal Diffuser | Direct

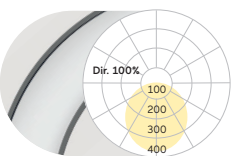

Chain Type	L mm	Colour Temperature	Control	Power	Lumen/Watt	Weight kg	Code Snow White	Code Radiant Silver	CHF
2 Rings	1940	4000K	On/Off	Low	9140lm/102W	28,0	RG3OWE-840E-2R-K	RG3OSE-840E-2R-K	7020,00
2 Rings	1940	4000K	On/Off	Medium	13380lm/156W	28,0	RG3OWE-840M-2R-K	RG3OSE-840M-2R-K	7020,00
3 Rings	2880	4000K	On/Off	Low	14360lm/151W	41,4	RG3OWE-840E-3R-K	RG3OSE-840E-3R-K	10567,00
3 Rings	2880	4000K	On/Off	Medium	21020lm/244W	41,4	RG3OWE-840M-3R-K	RG3OSE-840M-3R-K	10567,00
4 Rings	3820	4000K	On/Off	Low	19580lm/200W	54,7	RG3OWE-840E-4R-K	RG3OSE-840E-4R-K	14002,00
4 Rings	3820	4000K	On/Off	Medium	28660lm/332W	54,7	RG3OWE-840M-4R-K	RG3OSE-840M-4R-K	14002,00
5 Rings	4760	4000K	On/Off	Low	24800lm/249W	68,1	RG3OWE-840E-5R-K	RG3OSE-840E-5R-K	17457,00
5 Rings	4760	4000K	On/Off	Medium	36300lm/420W	68,1	RG3OWE-840M-5R-K	RG3OSE-840M-5R-K	17457,00



AW Micro Perforated

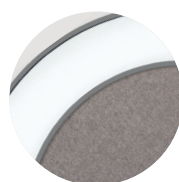

BW: Beige Wool

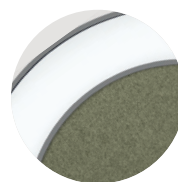

ZW: Green Wool

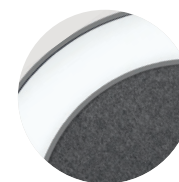

GW: Graphite Wool

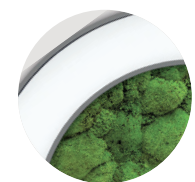

AM Green Moss

Surface Finish		CHF	Control Gear		CHF	Colour Rendering		CHF	Colour Temperature		CHF	Additional Options		CHF
W: Snow White	✓		E: On/Off	✓		8: CRI>80	✓		22: 2200K	+5%		Acoustic Absorber	🔔	
V: Ivory White	✓		L: DALI	+8%		9: CRI>90	+5%		27: 2700K	+5%				
S: Radiant Silver	✓		H: Touch-Dim	+8%		F: Full Spectrum	+15%		30: 3000K	✓				
U: Urban Graphite	✓		C: Casambi*	+15%					35: 3500K	+5%				
B: Jet Black	✓		U: Separately Dimmable DALI	+8%					40: 4000K	✓				
H: Anodic Champagne	+10%								65: 6500K	+5%				
K: Satin Copper	+15%													
R: Special RAL/NCS Colours	🔔													

*Only in combination with DALI. Please add to dimming price.

🟢 standard / no extra charge 🔔 on request 🚫 not available

Ringo Star Oblong GX/PX | Suspended

catalogue page 244

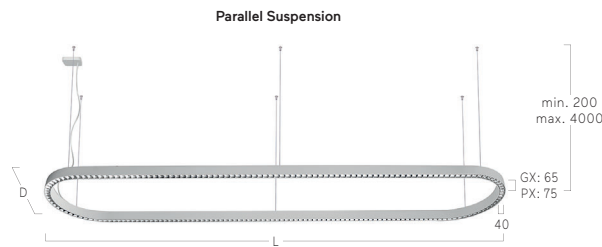

Midpin Spotlight XP
770lm/10W/Ø40mm



Lens Louvre | Direct-Indirect

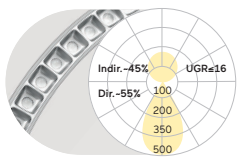

Code	Size	Colour Temperature	Control	Power	Lumen/Watt	Weight kg	Code Snow White/Jet Black	Code Jet Black/Jet Black	CHF
O61	L1790/D600	4000K	On/Off	Low	12860lm/100W	12,8	RPXLWE-840E-O61-KB*	RPXLB E-840E-O61-KB*	5618,00
O61	L1790/D600	4000K	On/Off	Medium	18000lm/145W	12,8	RPXLWE-840M-O61-KB*	RPXLB E-840M-O61-KB*	5618,00
O62	L2450/D600	4000K	On/Off	Low	16980lm/134W	16,8	RPXLWE-840E-O62-KB*	RPXLB E-840E-O62-KB*	8435,00
O62	L2450/D600	4000K	On/Off	Medium	23790lm/189W	16,8	RPXLWE-840M-O62-KB*	RPXLB E-840M-O62-KB*	8435,00
O91	L1820/D900	4000K	On/Off	Low	14070lm/107W	14,0	RPXLWE-840E-O91-KB*	RPXLB E-840E-O91-KB*	6738,00
O91	L1820/D900	4000K	On/Off	Medium	19650lm/156W	14,0	RPXLWE-840M-O91-KB*	RPXLB E-840M-O91-KB*	6738,00
O92	L2480/D900	4000K	On/Off	Low	18200lm/139W	18,0	RPXLWE-840E-O92-KB*	RPXLB E-840E-O92-KB*	10115,00
O92	L2480/D900	4000K	On/Off	Medium	25430lm/201W	18,0	RPXLWE-840M-O92-KB*	RPXLB E-840M-O92-KB*	10115,00

Lens Louvre | Direct

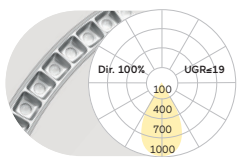

Code	Size	Colour Temperature	Control	Power	Lumen/Watt	Weight kg	Code Snow White/Jet Black	Code Jet Black/Jet Black	CHF
O61	L1790/D600	4000K	On/Off	Low	6770lm/53W	10,5	RGXLWE-840E-O61-KB*	RGXLB E-840E-O61-KB*	5058,00
O61	L1790/D600	4000K	On/Off	High	12350lm/102W	10,5	RGXLWE-840H-O61-KB*	RGXLB E-840H-O61-KB*	5058,00
O62	L2450/D600	4000K	On/Off	Low	8940lm/71W	14,0	RGXLWE-840E-O62-KB*	RGXLB E-840E-O62-KB*	7578,00
O62	L2450/D600	4000K	On/Off	High	16340lm/133W	14,0	RGXLWE-840H-O62-KB*	RGXLB E-840H-O62-KB*	7578,00
O91	L1820/D900	4000K	On/Off	Low	7400lm/55W	12,0	RGXLWE-840E-O91-KB*	RGXLB E-840E-O91-KB*	5810,00
O91	L1820/D900	4000K	On/Off	High	13570lm/109W	12,0	RGXLWE-840H-O91-KB*	RGXLB E-840H-O91-KB*	5810,00
O92	L2480/D900	4000K	On/Off	Low	9580lm/73W	15,0	RGXLWE-840E-O92-KB*	RGXLB E-840E-O92-KB*	8663,00
O92	L2480/D900	4000K	On/Off	High	17560lm/148W	15,0	RGXLWE-840H-O92-KB*	RGXLB E-840H-O92-KB*	8663,00

Opal Flex Diffuser | Direct-Indirect

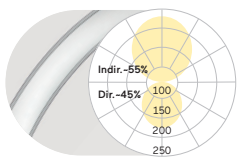

Code	Size	Colour Temperature	Control	Power	Lumen/Watt	Weight kg	Code Snow White	Code Jet Black	CHF
O61	L1790/D600	4000K	On/Off	Low	10580lm/93W	12,8	RPXCWE-840E-O61-K	RPXCB E-840E-O61-K	4883,00
O61	L1790/D600	4000K	On/Off	Medium	14640lm/133W	12,8	RPXCWE-840M-O61-K	RPXCB E-840M-O61-K	4883,00
O62	L2450/D600	4000K	On/Off	Low	13950lm/122W	16,8	RPXCWE-840E-O62-K	RPXCB E-840E-O62-K	7315,00
O62	L2450/D600	4000K	On/Off	Medium	19320lm/171W	16,8	RPXCWE-840M-O62-K	RPXCB E-840M-O62-K	7315,00
O91	L1820/D900	4000K	On/Off	Low	11550lm/103W	14,0	RPXCWE-840E-O91-K	RPXCB E-840E-O91-K	5863,00
O91	L1820/D900	4000K	On/Off	Medium	15910lm/143W	14,0	RPXCWE-840M-O91-K	RPXCB E-840M-O91-K	5863,00
O92	L2480/D900	4000K	On/Off	Low	14920lm/130W	18,0	RPXCWE-840E-O92-K	RPXCB E-840E-O92-K	8698,00
O92	L2480/D900	4000K	On/Off	Medium	20580lm/182W	18,0	RPXCWE-840M-O92-K	RPXCB E-840M-O92-K	8698,00

Opal Flex Diffuser | Direct

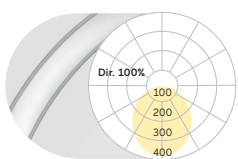

Code	Size	Colour Temperature	Control	Power	Lumen/Watt	Weight kg	Code Snow White	Code Jet Black	CHF
O61	L1790/D600	4000K	On/Off	Medium	6250lm/64W	10,5	RGXCWE-840M-O61-K	RGXCB E-840M-O61-K	4603,00
O61	L1790/D600	4000K	On/Off	High	8880lm/92W	10,5	RGXCWE-840H-O61-K	RGXCB E-840H-O61-K	4603,00
O62	L2450/D600	4000K	On/Off	Medium	8240lm/81W	14,0	RGXCWE-840M-O62-K	RGXCB E-840M-O62-K	6895,00
O62	L2450/D600	4000K	On/Off	High	11730lm/121W	14,0	RGXCWE-840H-O62-K	RGXCB E-840H-O62-K	6895,00
O91	L1820/D900	4000K	On/Off	Medium	6800lm/70W	12,0	RGXCWE-840M-O91-K	RGXCB E-840M-O91-K	5215,00
O91	L1820/D900	4000K	On/Off	High	9610lm/101W	12,0	RGXCWE-840H-O91-K	RGXCB E-840H-O91-K	5215,00
O92	L2480/D900	4000K	On/Off	Medium	8790lm/88W	15,0	RGXCWE-840M-O92-K	RGXCB E-840M-O92-K	7910,00
O92	L2480/D900	4000K	On/Off	High	12460lm/130W	15,0	RGXCWE-840H-O92-K	RGXCB E-840H-O92-K	7910,00

Surcharges

Surface Finish	CHF	Control Gear	CHF	Colour Rendering	CHF	Colour Temperature	CHF	Reflector Finish	CHF
W: Snow White	✓	E: On/Off	✓	8: CRI>80	✓	22: 2200K	+5%	W: Snow White	✓
V: Ivory White	✓	L: DALI	+172,00	9: CRI>90	+5%	27: 2700K	+5%	A: Satin Silver	✓
S: Radiant Silver	✓	H: Touch-Dim	+172,00	F: Full Spectrum	+15%	30: 3000K	✓	B: Jet Black	✓
A: Satin Silver	+15%	C: Casambi*	+261,00	Additional Options	CHF	35: 3500K	+5%	H: Anodic Champagne	✓
U: Urban Graphite	✓			Midpin Spotlight XP	+247,00	40: 4000K	✓	K: Satin Copper	✓
B: Jet Black	✓					65: 6500K	+5%	G: Satin Gold	✓
H: Anodic Champagne	+10%								
K: Satin Copper	+15%								
R: Special RAL/NCS Colours	🔴								

*Only in combination with DALI. Please add to dimming price.

✓ standard / no extra charge 🔴 on request ✗ not available

Liquid Line Compact G5/P5 | Suspended

catalogue page 246

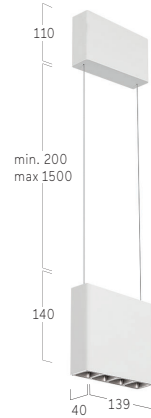

Lens Louvre | Direct-Indirect

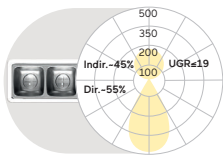

L mm	Colour Temperature	Control	Power	Lumen/Watt	Weight kg	Code Snow White/Jet Black	Code Jet Black/Jet Black	CHF
139	4000K	On/Off	Medium	1080lm/12W	1,5	QP5LWE-840M-L139-KB*	QP5LBE-840M-L139-KB*	779,00
139	4000K	On/Off	High	1450lm/16W	1,5	QP5LWE-840H-L139-KB*	QP5LBE-840H-L139-KB*	779,00

Lens Louvre | Direct

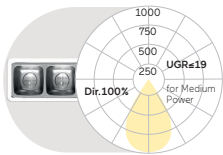

L mm	Colour Temperature	Control	Power	Lumen/Watt	Weight kg	Code Snow White/Jet Black	Code Jet Black/Jet Black	CHF
139	4000K	On/Off	Medium	620lm/7W	1,4	QG5LWE-840M-L139-KB*	QG5LBE-840M-L139-KB*	674,00
139	4000K	On/Off	High	820lm/9W	1,4	QG5LWE-840H-L139-KB*	QG5LBE-840H-L139-KB*	674,00

Opal Diffuser | Direct-Indirect

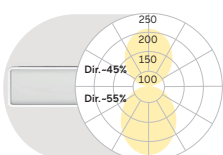

L mm	Colour Temperature	Control	Power	Lumen/Watt	Weight kg	Code Snow White	Code Jet Black	CHF
139	4000K	On/Off	Medium	990lm/12W	1,5	QP5OWE-840M-L139-K	QP5OBE-840M-L139-K	697,00
139	4000K	On/Off	High	1350lm/16W	1,5	QP5OWE-840H-L139-K	QP5OBE-840H-L139-K	697,00

Opal Diffuser | Direct

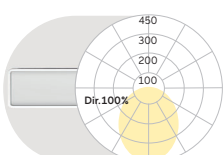

L mm	Colour Temperature	Control	Power	Lumen/Watt	Weight kg	Code Snow White	Code Jet Black	CHF
139	4000K	On/Off	Medium	530lm/7W	1,4	QG5OWE-840M-L139-K	QG5OBE-840M-L139-K	592,00
139	4000K	On/Off	High	720lm/9W	1,4	QG5OWE-840H-L139-K	QG5OBE-840H-L139-K	592,00

Surcharges

Surface Finish	CHF	Control Gear	CHF	Colour Rendering	CHF	Colour Temperature	CHF	Lens Louvre*	CHF
W: Snow White	✓	E: On/Off	✓	8: CRI>80	✓	22: 2200K	+5%	W: Snow White	✓
V: Ivory White	✓	L: DALI	+86,00	9: CRI>90	+5%	27: 2700K	+5%	A: Satin Silver	✓
A: Satin Silver	+15%	H: Touch-Dim	+86,00	F: Full Spectrum	+15%	30: 3000K	✓	B: Jet Black	✓
S: Radiant Silver	✓	C: DALI				35: 3500K	+5%	H: Anodic Champagne	✓
U: Urban Graphite	✓	R: Special RAL/NCS Colours	🔴			40: 4000K	✓	G: Satin Gold	✓
						65: 6500K	+5%	K: Satin Copper	✓

✓ standard / no extra charge 🔴 on request ✗ not available

Liquid Line GX/PX | System 40mm Suspended

catalogue page 248



Single Cord Suspension



DE System aus linearen, vertikal und horizontal gebogenen Komponenten sowie Y- und X-Verbindungselementen. Auf Grundlage skizzierter Kundenvorgabe erstellt Lightnet technische Zeichnung der gewünschten Struktur zur Prüfung und Freigabe. Zeichnungen für mögliche Radien, X- und Y-Module siehe Katalog. Sonderradien bei Opal-Flex Diffuser möglich.

EN System consisting of linear elements, vertically and horizontally curved elements and Y- and X-connectors. Based on customer specification, Lightnet creates technical drawings of the desired structure for review and approval. For drawings of possible curves, X- and Y-modules, see catalog. Special curves possible for Opal-Flex diffuser.

FR Système d'éclairage sur-mesure des éléments/modules droits-linéaires, verticaux et horizontaux cintrés, tout comme des connections/jonctions en forme de Y et X. Sur la base des schémas et spécifications voulues par le client, Lightnet crée les dessins techniques de la structure sur-mesure souhaitée pour contrôle et validation avant mise en production. Pour les dessins des rayons possibles et des modules X et Y, voir le catalogue. Rayons spéciaux possibles pour les diffusCHFs Opal-Flex.



Lens Louvre | Direct-Indirect

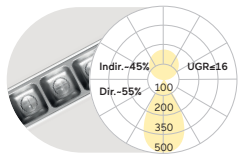

L mm	Colour Temperature	Control	Power	Lumen/Watt	Weight kg	Code Snow White/Jet Black	Code Jet Black/Jet Black	CHF
Liquid Line per meter (Lineare Teilstücke Straight Sections Sections droites)								
per meter	4000K	On/Off	Low	3070lm/23,7W	3,0	QPXLWE-840E-L****-KB*	QPXLB E-840E-L****-KB*	839,00
per meter	4000K	On/Off	Medium	4340lm/34,2W	3,0	QPXLWE-840M-L****-KB*	QPXLB E-840M-L****-KB*	839,00
per meter	4000K	DALI	Low	3070lm/23,7W	3,0	QPXLWL-840E-L****-KB*	QPXLBL-840E-L****-KB*	909,00
per meter	4000K	DALI	Medium	4340lm/34,2W	3,0	QPXLWL-840M-L****-KB*	QPXLBL-840M-L****-KB*	909,00
Liquid Line per meter (Gebogene Teilstücke Curved and bent Sections Courbes Sections)								
per meter	4000K	On/Off	Low	3070lm/23,7W	3,0	QPXLWE-840E-L****-KB*	QPXLB E-840E-L****-KB*	1397,00
per meter	4000K	On/Off	Medium	4340lm/34,2W	3,0	QPXLWE-840M-L****-KB*	QPXLB E-840M-L****-KB*	1397,00
per meter	4000K	DALI	Low	3070lm/23,7W	3,0	QPXLWL-840E-L****-KB*	QPXLBL-840E-L****-KB*	1467,00
per meter	4000K	DALI	Medium	4340lm/34,2W	3,0	QPXLWL-840M-L****-KB*	QPXLBL-840M-L****-KB*	1467,00

Lens Louvre | Direct

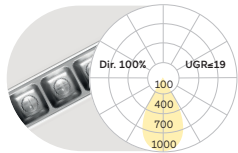

L mm	Colour Temperature	Control	Power	Lumen/Watt	Weight kg	Code Snow White/Jet Black	Code Jet Black/Jet Black	CHF
Liquid Line per meter (Lineare Teilstücke Straight Sections Sections droites)								
per meter	4000K	On/Off	Low	1640lm/12,6W	2,3	QGXLWE-840E-L****-KB*	QGXLBE-840E-L****-KB*	664,00
per meter	4000K	On/Off	High	3020lm/24,3W	2,3	QGXLWE-840H-L****-KB*	QGXLBE-840H-L****-KB*	664,00
per meter	4000K	DALI	Low	1640lm/12,6W	2,3	QGXLWL-840E-L****-KB*	QGXLBL-840E-L****-KB*	716,00
per meter	4000K	DALI	High	3020lm/24,3W	2,3	QGXLWL-840H-L****-KB*	QGXLBL-840H-L****-KB*	716,00
Liquid Line per meter (Gebogene Teilstücke Curved and bent Sections Courbes Sections)								
per meter	4000K	On/Off	Low	1640lm/12,6W	2,3	QGXLWE-840E-L****-KB*	QGXLBE-840E-L****-KB*	1222,00
per meter	4000K	On/Off	High	3020lm/24,3W	2,3	QGXLWE-840H-L****-KB*	QGXLBE-840H-L****-KB*	1222,00
per meter	4000K	DALI	Low	1640lm/12,6W	2,3	QGXLWL-840E-L****-KB*	QGXLBL-840E-L****-KB*	1274,00
per meter	4000K	DALI	High	3020lm/24,3W	2,3	QGXLWL-840H-L****-KB*	QGXLBL-840H-L****-KB*	1274,00

Opal Flex Diffuser | Direct-Indirect

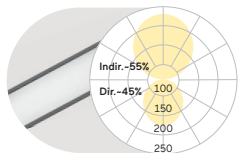

L mm	Colour Temperature	Control	Power	Lumen/Watt	Weight kg	Code Snow White	Code Jet Black	CHF
Liquid Line per meter (Lineare Teilstücke Straight Sections Sections droites)								
per meter	4000K	On/Off	Low	2540lm/22,2W	3,0	QPXCWE-840E-L****-K	QPXCBE-840E-L****-K	699,00
per meter	4000K	On/Off	Medium	3550lm/31,4W	3,0	QPXCWE-840M-L****-K	QPXCBE-840M-L****-K	699,00
per meter	4000K	DALI	Low	2540lm/22,2W	3,0	QPXCWL-840E-L****-K	QPXCBL-840E-L****-K	769,00
per meter	4000K	DALI	Medium	3550lm/31,4W	3,0	QPXCWL-840M-L****-K	QPXCBL-840M-L****-K	769,00
Liquid Line per meter (Gebogene Teilstücke Curved and bent Sections Courbes Sections)								
per meter	4000K	On/Off	Low	2540lm/22,2W	3,0	QPXCWE-840E-L****-K	QPXCBE-840E-L****-K	1014,00
per meter	4000K	On/Off	Medium	3550lm/31,4W	3,0	QPXCWE-840M-L****-K	QPXCBE-840M-L****-K	1014,00
per meter	4000K	DALI	Low	2540lm/22,2W	3,0	QPXCWL-840E-L****-K	QPXCBL-840E-L****-K	1084,00
per meter	4000K	DALI	Medium	3550lm/31,4W	3,0	QPXCWL-840M-L****-K	QPXCBL-840M-L****-K	1084,00
Liquid Line per meter (Wellenförmige Teilstücke Wave Sections Sections d'onde)								
per meter	4000K	On/Off	Low	2540lm/22,2W	3,0	QPXCWE-840E-L****-K	QPXCBE-840E-L****-K	2690,00
per meter	4000K	On/Off	Medium	3550lm/31,4W	3,0	QPXCWE-840M-L****-K	QPXCBE-840M-L****-K	2690,00
per meter	4000K	DALI	Low	2540lm/22,2W	3,0	QPXCWL-840E-L****-K	QPXCBL-840E-L****-K	2760,00
per meter	4000K	DALI	Medium	3550lm/31,4W	3,0	QPXCWL-840M-L****-K	QPXCBL-840M-L****-K	2760,00

Zusätzlicher Preis per X-Junction Module | Additional Price per X-Junction Module | Prix supplémentaire par module X-Junction +438,00
 Zusatzlicher Preis per Y-Junction Module | Additional Price per Y-Junction Module | Prix supplémentaire par module Y-Junction +385,00

**** Your length in mm
 Meterpreise für Lichtsysteme nach Maß ab Mindestlänge 2200mm | Prices per metre for customised lighting systems with a minimum length of 2200mm
 Prix au mètre pour systèmes d'éclairage sur mesure à partir d'une longueur minimale de 2200mm

Opal Flex Diffuser | Direct

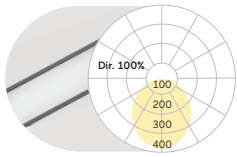

L mm	Colour Temperature	Control	Power	Lumen/Watt	Weight kg	Code Snow White	Code Jet Black	CHF
Liquid Line per meter (Lineare Teilstücke Straight Sections Sections droites)								
per meter	4000K	On/Off	Medium	1550lm/15,6W	2,3	QGXCWE-840M-L****-K	QGXCBE-840M-L****-K	524,00
per meter	4000K	On/Off	High	2150lm/21,8W	2,3	QGXCWE-840H-L****-K	QGXCBE-840H-L****-K	524,00
per meter	4000K	DALI	Medium	1550lm/15,6W	2,3	QGXCWL-840M-L****-K	QGXCBL-840M-L****-K	594,00
per meter	4000K	DALI	High	2150lm/21,8W	2,3	QGXCWL-840H-L****-K	QGXCBL-840H-L****-K	594,00
Liquid Line per meter (Gebogene Teilstücke Curved and bent Sections Courbes Sections)								
per meter	4000K	On/Off	Medium	1550lm/15,6W	2,3	QGXCWE-840M-L****-K	QGXCBE-840M-L****-K	874,00
per meter	4000K	On/Off	High	2150lm/21,8W	2,3	QGXCWE-840H-L****-K	QGXCBE-840H-L****-K	874,00
per meter	4000K	DALI	Medium	1550lm/15,6W	2,3	QGXCWL-840M-L****-K	QGXCBL-840M-L****-K	926,00
per meter	4000K	DALI	High	2150lm/21,8W	2,3	QGXCWL-840H-L****-K	QGXCBL-840H-L****-K	926,00
Liquid Line per meter (Wellenförmige Teilstücke Wave Sections Sections d'onde)								
per meter	4000K	On/Off	Medium	1550lm/15,6W	2,3	QGXCWE-840M-L****-K	QGXCBE-840M-L****-K	2589,00
per meter	4000K	On/Off	High	2150lm/21,8W	2,3	QGXCWE-840H-L****-K	QGXCBE-840H-L****-K	2589,00
per meter	4000K	DALI	Medium	1550lm/15,6W	2,3	QGXCWL-840M-L****-K	QGXCBL-840M-L****-K	2641,00
per meter	4000K	DALI	High	2150lm/21,8W	2,3	QGXCWL-840H-L****-K	QGXCBL-840H-L****-K	2641,00
Zusätzlicher Preis per X-Junction Module Additional Price per X-Junction Module Prix supplémentaire par module X-Junction								+438,00
Zusätzlicher Preis per Y-Junction Module Additional Price per Y-Junction Module Prix supplémentaire par module Y-Junction								+385,00

**** Your length in mm

Meterpreise für Lichtsysteme nach Maß ab Mindestlänge 2200mm | Prices per metre for customised lighting systems with a minimum length of 2200mm
 Prix au mètre pour systèmes d'éclairage sur mesure à partir d'une longueur minimale de 2200mm



Linear Module



Curve Module (Opal-Flex)



Curve Module (Louvre)



Wave Module (Convex, Opal-Flex)



Wave Module (Concave, Opal-Flex)

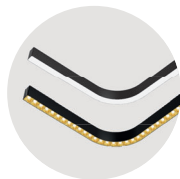

Bend Module



X-Junction Module (Opal-Flex)



Y-Junction Module (Opal-Flex)

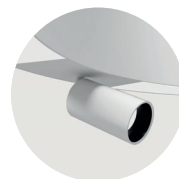

Midpin Spotlight XM



Midpin Spotlight XP



W Snow White
W Snow White



A Satin Silver
A Satin Silver



B Jet Black
B Jet Black



H Anodic Champagne
H Anodic Champagne

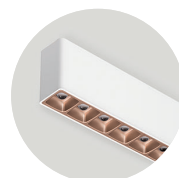

K Satin Copper
K Satin Copper



G Satin Gold
G Satin Gold

Surcharges

Surface Finish	CHF	Control Gear	CHF	Colour Temperature	CHF	Reflector Colour	CHF	Additional Options	CHF
W: Snow White	✓	E: On/Off	✓	22: 2200K	+5%	W: Snow White	✓	Midpin Spotlight XM	+363,00
V: Ivory White	✓	L: DALI	✓	27: 2700K	+5%	A: Satin Silver	✓	Midpin Spotlight XP	+433,00
A: Satin Silver	+15%	H: Touch-Dim	⚠	30: 3000K	✓	B: Jet Black	✓		
U: Urban Graphite	✓	C: Casambi	⚠	35: 3500K	+5%	H: Anodic Champagne	✓		
B: Jet Black	✓	Colour Rendering	CHF	40: 4000K	✓	K: Satin Copper	✓		
H: Anodic Champagne	+10%	8: CRI>80	✓	65: 6500K	+5%	G: Satin Gold	✓		
K: Satin Copper	+15%	9: CRI>90	+5%						
R: Special RAL/NCS Colours	⚠	F: Full Spectrum	+15%						

✓ standard / no extra charge ⚠ on request ✗ not available

Liquid Line G3/P3 | System 60mm Suspended

catalogue page 264



Single Cord Suspension:

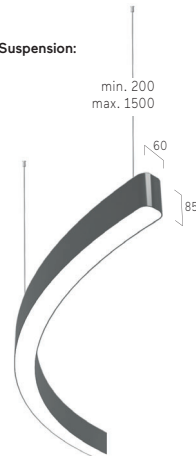

DE System aus linearen, vertikal und horizontal gebogenen Komponenten sowie Y- und X-Verbindungselementen. Auf Grundlage skizzierter Kundenvorgabe erstellt Lightnet technische Zeichnung der gewünschten Struktur zur Prüfung und Freigabe. Zeichnungen für mögliche Radien, X- und Y-Module siehe Katalog. Sonderradien möglich.

EN System consisting of linear elements, vertically and horizontally curved elements and Y- and X-connectors. Based on customer specification, Lightnet creates technical drawings of the desired structure for review and approval. For drawings of possible curves, X- and Y-modules, see catalog. Special curves possible for Opal-Flex diffuser.

FR Système d'éclairage sur-mesure des éléments/modules droits-linéaires, verticaux et horizontaux cintrés, tout comme des connections/jonctions en forme de Y et X. Sur la base des schémas et spécifications voulues par le client, Lightnet crée les dessins techniques de la structure sur-mesure souhaitée pour contrôle et validation avant mise en production. Pour les dessins des rayons possibles et des modules X et Y, voir le catalogue. Rayons spéciaux possibles pour les diffusCHFs Opal-Flex.



Microprismatic | Direct-Indirect

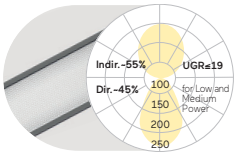

L mm	Colour Temperature	Control	Power	Lumen/Watt	Weight kg	Code Snow White	Code Jet Black	CHF
Liquid Line per meter (Lineare Teilstücke Straight Sections Sections droites)								
per meter	4000K	On/Off	Low	2670lm/24,0W	4,0	QP3AWE-840E-L****-K	QP3ABE-840E-L****-K	874,00
per meter	4000K	On/Off	Medium	3780lm/35,6W	4,0	QP3AWE-840M-L****-K	QP3ABE-840M-L****-K	874,00
per meter	4000K	On/Off	High	5250lm/50,4W	4,0	QP3AWE-840H-L****-K	QP3ABE-840H-L****-K	874,00
per meter	4000K	DALI	Low	2670lm/24,0W	4,0	QP3AWL-840E-L****-K	QP3ABL-840E-L****-K	944,00
per meter	4000K	DALI	Medium	3780lm/35,6W	4,0	QP3AWL-840M-L****-K	QP3ABL-840M-L****-K	944,00
per meter	4000K	DALI	High	5250lm/50,4W	4,0	QP3AWL-840H-L****-K	QP3ABL-840H-L****-K	944,00
Liquid Line per meter (Gebogene Teilstücke Curved and bent Sections Courbes Sections)								
per meter	4000K	On/Off	Low	2670lm/24,0W	4,0	QP3AWE-840E-L****-K	QP3ABE-840E-L****-K	1255,00
per meter	4000K	On/Off	Medium	3780lm/35,6W	4,0	QP3AWE-840M-L****-K	QP3ABE-840M-L****-K	1255,00
per meter	4000K	On/Off	High	5250lm/50,4W	4,0	QP3AWE-840H-L****-K	QP3ABE-840H-L****-K	1255,00
per meter	4000K	DALI	Low	2670lm/24,0W	4,0	QP3AWL-840E-L****-K	QP3ABL-840E-L****-K	1325,00
per meter	4000K	DALI	Medium	3780lm/35,6W	4,0	QP3AWL-840M-L****-K	QP3ABL-840M-L****-K	1325,00
per meter	4000K	DALI	High	5250lm/50,4W	4,0	QP3AWL-840H-L****-K	QP3ABL-840H-L****-K	1325,00
Liquid Line per meter (Wellenförmige Teilstücke Wave Sections Sections d'onde)								
per meter	4000K	On/Off	Low	2670lm/24,0W	4,0	QP3AWE-840E-L****-K	QP3ABE-840E-L****-K	2725,00
per meter	4000K	On/Off	Medium	3780lm/35,6W	4,0	QP3AWE-840M-L****-K	QP3ABE-840M-L****-K	2725,00
per meter	4000K	On/Off	High	5250lm/50,4W	4,0	QP3AWE-840H-L****-K	QP3ABE-840H-L****-K	2725,00
per meter	4000K	DALI	Low	2670lm/24,0W	4,0	QP3AWL-840E-L****-K	QP3ABL-840E-L****-K	2795,00
per meter	4000K	DALI	Medium	3780lm/35,6W	4,0	QP3AWL-840M-L****-K	QP3ABL-840M-L****-K	2795,00
per meter	4000K	DALI	High	5250lm/50,4W	4,0	QP3AWL-840H-L****-K	QP3ABL-840H-L****-K	2795,00
Zusätzlicher Preis per X-Junction Module Additional Price per X-Junction Module Prix supplémentaire par module X-Junction								+438,00
Zusätzlicher Preis per Y-Junction Module Additional Price per Y-Junction Module Prix supplémentaire par module Y-Junction								+385,00

Microprismatic | Direct

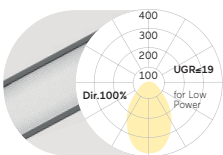

L mm	Colour Temperature	Control	Power	Lumen/Watt	Weight kg	Code Snow White	Code Jet Black	CHF
Liquid Line per meter (Lineare Teilstücke Straight Sections Sections droites)								
per meter	4000K	On/Off	Low	1200lm/14,6W	3,5	QG3AWE-840E-L****-K	QG3ABE-840E-L****-K	681,00
per meter	4000K	On/Off	Medium	1760lm/22,5W	3,5	QG3AWE-840M-L****-K	QG3ABE-840M-L****-K	681,00
per meter	4000K	On/Off	High	2290lm/30,3W	3,5	QG3AWE-840H-L****-K	QG3ABE-840H-L****-K	681,00
per meter	4000K	DALI	Low	1200lm/14,6W	3,5	QG3AWL-840E-L****-K	QG3ABL-840E-L****-K	734,00
per meter	4000K	DALI	Medium	1760lm/22,5W	3,5	QG3AWL-840M-L****-K	QG3ABL-840M-L****-K	734,00
per meter	4000K	DALI	High	2290lm/30,3W	3,5	QG3AWL-840H-L****-K	QG3ABL-840H-L****-K	734,00
Liquid Line per meter (Gebogene Teilstücke Curved and bent Sections Courbes Sections)								
per meter	4000K	On/Off	Low	1200lm/14,6W	3,5	QG3AWE-840E-L****-K	QG3ABE-840E-L****-K	1031,00
per meter	4000K	On/Off	Medium	1760lm/22,5W	3,5	QG3AWE-840M-L****-K	QG3ABE-840M-L****-K	1031,00
per meter	4000K	On/Off	High	2290lm/30,3W	3,5	QG3AWE-840H-L****-K	QG3ABE-840H-L****-K	1031,00
per meter	4000K	DALI	Low	1200lm/14,6W	3,5	QG3AWL-840E-L****-K	QG3ABL-840E-L****-K	1084,00
per meter	4000K	DALI	Medium	1760lm/22,5W	3,5	QG3AWL-840M-L****-K	QG3ABL-840M-L****-K	1084,00
per meter	4000K	DALI	High	2290lm/30,3W	3,5	QG3AWL-840H-L****-K	QG3ABL-840H-L****-K	1084,00
Liquid Line per meter (Wellenförmige Teilstücke Wave Sections Sections d'onde)								
per meter	4000K	On/Off	Low	1200lm/14,6W	3,5	QG3AWE-840E-L****-K	QG3ABE-840E-L****-K	2725,00
per meter	4000K	On/Off	Medium	1760lm/22,5W	3,5	QG3AWE-840M-L****-K	QG3ABE-840M-L****-K	2725,00
per meter	4000K	On/Off	High	2290lm/30,3W	3,5	QG3AWE-840H-L****-K	QG3ABE-840H-L****-K	2725,00
per meter	4000K	DALI	Low	1200lm/14,6W	3,5	QG3AWL-840E-L****-K	QG3ABL-840E-L****-K	2795,00
per meter	4000K	DALI	Medium	1760lm/22,5W	3,5	QG3AWL-840M-L****-K	QG3ABL-840M-L****-K	2795,00
per meter	4000K	DALI	High	2290lm/30,3W	3,5	QG3AWL-840H-L****-K	QG3ABL-840H-L****-K	2676,00
Zusätzlicher Preis per X-Junction Module Additional Price per X-Junction Module Prix supplémentaire par module X-Junction								+438,00
Zusätzlicher Preis per Y-Junction Module Additional Price per Y-Junction Module Prix supplémentaire par module Y-Junction								+385,00

**** Your length in mm

Meterpreise für Lichtsysteme nach Maß ab Mindestlänge 2200mm | Prices per metre for customised lighting systems with a minimum length of 2200mm
 Prix au mètre pour systèmes d'éclairage sur mesure à partir d'une longueur minimale de 2200mm

Opal Diffuser | Direct-Indirect

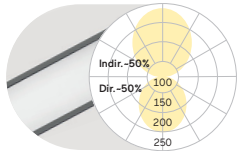

L mm	Colour Temperature	Control	Power	Lumen/Watt	Weight kg	Code Snow White	Code Jet Black	CHF
Liquid Line per meter (Lineare Teilstücke Straight Sections Sections droites)								
per meter	4000K	On/Off	Low	2770lm/24,0W	4,0	QP3OWE-840E-L****-K	QP3OBE-840E-L****-K	839,00
per meter	4000K	On/Off	Medium	3930lm/35,6W	4,0	QP3OWE-840M-L****-K	QP3OBE-840M-L****-K	839,00
per meter	4000K	On/Off	High	5440lm/50,4W	4,0	QP3OWE-840H-L****-K	QP3OBE-840H-L****-K	839,00
per meter	4000K	DALI	Low	2770lm/24,0W	4,0	QP3OWL-840E-L****-K	QP3OBL-840E-L****-K	909,00
per meter	4000K	DALI	Medium	3930lm/35,6W	4,0	QP3OWL-840M-L****-K	QP3OBL-840M-L****-K	909,00
per meter	4000K	DALI	High	5440lm/50,4W	4,0	QP3OWL-840H-L****-K	QP3OBL-840H-L****-K	909,00
Liquid Line per meter (Gebogene Teilstücke Curved and bent Sections Courbes Sections)								
per meter	4000K	On/Off	Low	2770lm/24,0W	4,0	QP3OWE-840E-L****-K	QP3OBE-840E-L****-K	1189,00
per meter	4000K	On/Off	Medium	3930lm/35,6W	4,0	QP3OWE-840M-L****-K	QP3OBE-840M-L****-K	1189,00
per meter	4000K	On/Off	High	5440lm/50,4W	4,0	QP3OWE-840H-L****-K	QP3OBE-840H-L****-K	1189,00
per meter	4000K	DALI	Low	2770lm/24,0W	4,0	QP3OWL-840E-L****-K	QP3OBL-840E-L****-K	1290,00
per meter	4000K	DALI	Medium	3930lm/35,6W	4,0	QP3OWL-840M-L****-K	QP3OBL-840M-L****-K	1290,00
per meter	4000K	DALI	High	5440lm/50,4W	4,0	QP3OWL-840H-L****-K	QP3OBL-840H-L****-K	1290,00
Liquid Line per meter (Wellenförmige Teilstücke Wave Sections Sections d'onde)								
per meter	4000K	On/Off	Low	2770lm/24,0W	4,0	QP3OWE-840E-L****-K	QP3OBE-840E-L****-K	2690,00
per meter	4000K	On/Off	Medium	3930lm/35,6W	4,0	QP3OWE-840M-L****-K	QP3OBE-840M-L****-K	2690,00
per meter	4000K	On/Off	High	5440lm/50,4W	4,0	QP3OWE-840H-L****-K	QP3OBE-840H-L****-K	2690,00
per meter	4000K	DALI	Low	2770lm/24,0W	4,0	QP3OWL-840E-L****-K	QP3OBL-840E-L****-K	2760,00
per meter	4000K	DALI	Medium	3930lm/35,6W	4,0	QP3OWL-840M-L****-K	QP3OBL-840M-L****-K	2760,00
per meter	4000K	DALI	High	5440lm/50,4W	4,0	QP3OWL-840H-L****-K	QP3OBL-840H-L****-K	2760,00
Zusätzlicher Preis per X-Junction Module Additional Price per X-Junction Module Prix supplémentaire par module X-Junction								+438,00
Zusätzlicher Preis per Y-Junction Module Additional Price per Y-Junction Module Prix supplémentaire par module Y-Junction								+385,00

Opal Diffuser | Direct

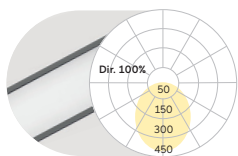

L mm	Colour Temperature	Control	Power	Lumen/Watt	Weight kg	Code Snow White	Code Jet Black	CHF
Liquid Line per meter (Lineare Teilstücke Straight Sections Sections droites)								
per meter	4000K	On/Off	Low	1300lm/14,6W	3,5	QG3OWE-840E-L****-K	QG3OBE-840E-L****-K	646,00
per meter	4000K	On/Off	Medium	1910lm/22,5W	3,5	QG3OWE-840M-L****-K	QG3OBE-840M-L****-K	646,00
per meter	4000K	On/Off	High	2480lm/30,3W	3,5	QG3OWE-840H-L****-K	QG3OBE-840H-L****-K	646,00
per meter	4000K	DALI	Low	1300lm/14,6W	3,5	QG3OWL-840E-L****-K	QG3OBL-840E-L****-K	699,00
per meter	4000K	DALI	Medium	1910lm/22,5W	3,5	QG3OWL-840M-L****-K	QG3OBL-840M-L****-K	699,00
per meter	4000K	DALI	High	2480lm/30,3W	3,5	QG3OWL-840H-L****-K	QG3OBL-840H-L****-K	699,00
Liquid Line per meter (Gebogene Teilstücke Curved and bent Sections Courbes Sections)								
per meter	4000K	On/Off	Low	1300lm/14,6W	3,5	QG3OWE-840E-L****-K	QG3OBE-840E-L****-K	996,00
per meter	4000K	On/Off	Medium	1910lm/22,5W	3,5	QG3OWE-840M-L****-K	QG3OBE-840M-L****-K	996,00
per meter	4000K	On/Off	High	2480lm/30,3W	3,5	QG3OWE-840H-L****-K	QG3OBE-840H-L****-K	996,00
per meter	4000K	DALI	Low	1300lm/14,6W	3,5	QG3OWL-840E-L****-K	QG3OBL-840E-L****-K	1049,00
per meter	4000K	DALI	Medium	1910lm/22,5W	3,5	QG3OWL-840M-L****-K	QG3OBL-840M-L****-K	1049,00
per meter	4000K	DALI	High	2480lm/30,3W	3,5	QG3OWL-840H-L****-K	QG3OBL-840H-L****-K	1049,00
Liquid Line per meter (Wellenförmige Teilstücke Wave Sections Sections d'onde)								
per meter	4000K	On/Off	Low	1300lm/14,6W	3,5	QG3OWE-840E-L****-K	QG3OBE-840E-L****-K	2589,00
per meter	4000K	On/Off	Medium	1910lm/22,5W	3,5	QG3OWE-840M-L****-K	QG3OBE-840M-L****-K	2589,00
per meter	4000K	On/Off	High	2480lm/30,3W	3,5	QG3OWE-840H-L****-K	QG3OBE-840H-L****-K	2589,00
per meter	4000K	DALI	Low	1300lm/14,6W	3,5	QG3OWL-840E-L****-K	QG3OBL-840E-L****-K	2641,00
per meter	4000K	DALI	Medium	1910lm/22,5W	3,5	QG3OWL-840M-L****-K	QG3OBL-840M-L****-K	2641,00
per meter	4000K	DALI	High	2480lm/30,3W	3,5	QG3OWL-840H-L****-K	QG3OBL-840H-L****-K	2641,00
Zusätzlicher Preis per X-Junction Module Additional Price per X-Junction Module Prix supplémentaire par module X-Junction								+438,00
Zusätzlicher Preis per Y-Junction Module Additional Price per Y-Junction Module Prix supplémentaire par module Y-Junction								+385,00

**** Your length in mm
 Meterpreise für Lichtsysteme nach Maß ab Mindestlänge 2200mm | Prices per metre for customised lighting systems with a minimum length of 2200mm
 Prix au mètre pour systèmes d'éclairage sur mesure à partir d'une longueur minimale de 2200mm



Linear Module



Corner Module



Curve Module



Curve Module



Wave Module (convex)



Wave Module (concave)



Bend Module



Bend Module

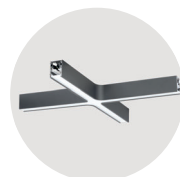

X-Junction Module

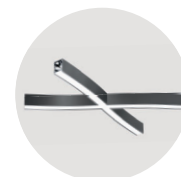

X-Junction Module

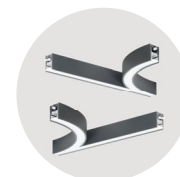

Y-Junction Module

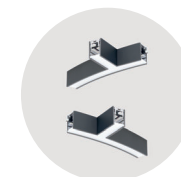

Y-Junction Module

... Liquid Line G3/P3 | System 60mm Suspended



Y-Junction Module



Y-Junction Module

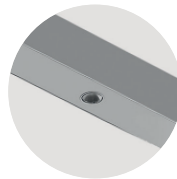

Midpin Downlight XD

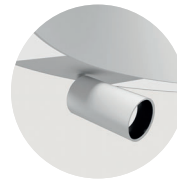

Midpin Spotlight XM



Midpin Spotlight XP



W Snow White



S Radiant Silver

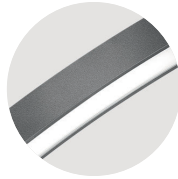

U Urban Graphite

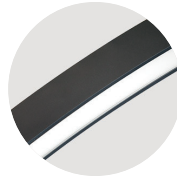

B Jet Black

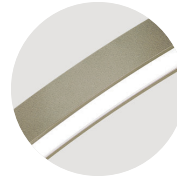

H Anodic Champagne

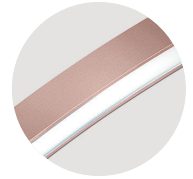

K Satin Copper

Surcharges	Surface Finish	CHF	Control Gear	CHF	Colour Rendering	CHF	Colour Temperature	CHF	Additional Options	CHF
W: Snow White	✓		E: On/Off	✓	8: CRI>80	✓	22: 2200K	+5%	Midpin Downlight XD	+363,00
V: Ivory White	✓		L: DALI	✓	9: CRI>90	+5%	27: 2700K	+5%	Midpin Spotlight XM	+363,00
A: Satin Silver	+15%		H: Touch-Dim	ⓘ	F: Full Spectrum	+15%	30: 3000K	✓	Midpin Spotlight XP	+433,00
U: Urban Graphite	✓		C: Casambi	ⓘ			35: 3500K	+5%		
B: Jet Black	✓						40: 4000K	✓		
H: Anodic Champagne	+10%						65: 6500K	+5%		
K: Satin Copper	+15%									
R: Special RAL/NCS Colours	ⓘ									

✓ standard / no extra charge
 ⓘ on request
 ✗ not available

Code Zero G3/P3 | Suspended

catalogue page 272

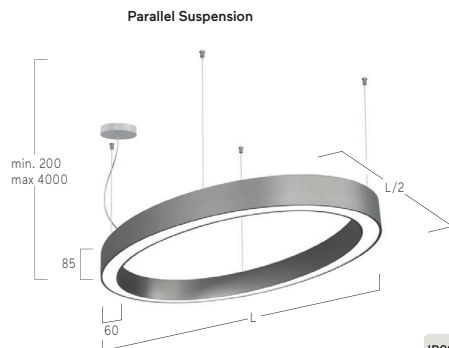

- IP20
- ~220-240V
- 50-60 Hz
- IK 02
- RG0
- ≤3 MacAdam
- MEDIUM POWER 1500lm/6000K
- HIGH POWER 1500lm/5000K
- CE
- UK CA

Opal Diffuser | Direct-Indirect

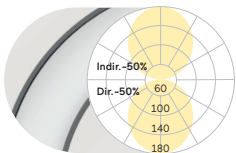

L mm	Colour Temperature	Control	Power	Lumen/Watt	Weight kg	Code Snow White	Code Radiant Silver	CHF
1500	4000K	On/Off	Medium	12830lm/120W	14,6	ZP30WE-840M-L1500-K	ZP30SE-840M-L1500-K	7032,00
1500	4000K	On/Off	High	18090lm/171W	14,6	ZP30WE-840H-L1500-K	ZP30SE-840H-L1500-K	7032,00
2000	4000K	On/Off	Medium	17070lm/158W	19,4	ZP30WE-840M-L2000-K	ZP30SE-840M-L2000-K	9072,00
2000	4000K	On/Off	High	23970lm/224W	19,4	ZP30WE-840H-L2000-K	ZP30SE-840H-L2000-K	9072,00
3000	4000K	On/Off	Medium	25030lm/238W	29,1	ZP30WE-840M-L3000-K	ZP30SE-840M-L3000-K	11669,00
3000	4000K	On/Off	High	35070lm/338W	29,1	ZP30WE-840H-L3000-K	ZP30SE-840H-L3000-K	11669,00

Opal Diffuser | Direct

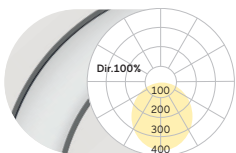

L mm	Colour Temperature	Control	Power	Lumen/Watt	Weight kg	Code Snow White	Code Radiant Silver	CHF
1500	4000K	On/Off	Medium	6550lm/78W	12,8	ZG30WE-840M-L1500-K	ZG30SE-840M-L1500-K	5548,00
1500	4000K	On/Off	High	8420lm/104W	12,8	ZG30WE-840H-L1500-K	ZG30SE-840H-L1500-K	5548,00
2000	4000K	On/Off	Medium	9070lm/106W	17,0	ZG30WE-840M-L2000-K	ZG30SE-840M-L2000-K	7403,00
2000	4000K	On/Off	High	11660lm/141W	17,0	ZG30WE-840H-L2000-K	ZG30SE-840H-L2000-K	7403,00
3000	4000K	On/Off	Medium	13610lm/161W	25,5	ZG30WE-840M-L3000-K	ZG30SE-840M-L3000-K	9814,00
3000	4000K	On/Off	High	17490lm/216W	25,5	ZG30WE-840H-L3000-K	ZG30SE-840H-L3000-K	9814,00

Surcharges	Surface Finish	CHF	Control Gear	CHF	Colour Rendering	CHF	Colour Temperature	CHF	Additional Options	CHF
W: Snow White	✓		E: On/Off	✓	8: CRI>80	✓	22: 2200K	+5%	Midpin Spotlight XP	+433,00
V: Ivory White	✓		L: DALI	+86,00	9: CRI>90	+5%	27: 2700K	+5%		
A: Satin Silver	+15%		H: Touch-Dim	+86,00	F: Full Spectrum	+15%	30: 3000K	✓		
U: Urban Graphite	✓		C: Casambi*	+261,00			35: 3500K	+5%		
B: Jet Black	✓						40: 4000K	✓		
H: Anodic Champagne	+10%						65: 6500K	+5%		
K: Satin Copper	+15%									
R: Special RAL/NCS Colours	ⓘ									

*Only in combination with DALI. Please add to dimming price.

✓ standard / no extra charge
 ⓘ on request
 ✗ not available

Caleo Inverse GX/PX | System 40mm Suspended

catalogue page 274

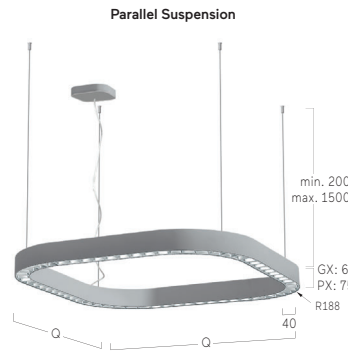

Lens Louvre | Direct-Indirect

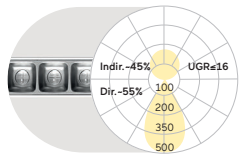

Q mm	Colour Temperature	Control	Power	Lumen/Watt	Weight kg	Code Snow White/Jet Black	Code Jet Black/Jet Black	CHF
640	4000K	On/Off	Low	6490lm/50W	7,0	APXLWE-840E-Q640-KB*	APXLB E-840E-Q640-KB*	2590,00
640	4000K	On/Off	Medium	9250lm/74W	7,0	APXLWE-840M-Q640-KB*	APXLB E-840M-Q640-KB*	2590,00
900	4000K	On/Off	Low	9690lm/74W	10,2	APXLWE-840E-Q900-KB*	APXLB E-840E-Q900-KB*	3010,00
900	4000K	On/Off	Medium	13880lm/109W	10,2	APXLWE-840M-Q900-KB*	APXLB E-840M-Q900-KB*	3010,00
1170	4000K	On/Off	Low	12910lm/97W	13,0	APXLWE-840E-Q1170-KB*	APXLB E-840E-Q1170-KB*	3588,00
1170	4000K	On/Off	Medium	18510lm/145W	13,0	APXLWE-840M-Q1170-KB*	APXLB E-840M-Q1170-KB*	3588,00

Lens Louvre | Direct

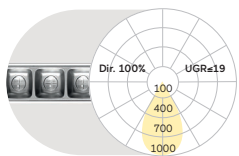

Q mm	Colour Temperature	Control	Power	Lumen/Watt	Weight kg	Code Snow White/Jet Black	Code Jet Black/Jet Black	CHF
640	4000K	On/Off	Low	3480lm/27W	5,8	AGXLWE-840E-Q640-KB*	AGXLB E-840E-Q640-KB*	2363,00
640	4000K	On/Off	High	6380lm/54W	5,8	AGXLWE-840H-Q640-KB*	AGXLB E-840H-Q640-KB*	2363,00
900	4000K	On/Off	Low	5220lm/39W	8,5	AGXLWE-840E-Q900-KB*	AGXLB E-840E-Q900-KB*	2713,00
900	4000K	On/Off	High	9580lm/78W	8,5	AGXLWE-840H-Q900-KB*	AGXLB E-840H-Q900-KB*	2713,00
1170	4000K	On/Off	Low	6960lm/51W	10,8	AGXLWE-840E-Q1170-KB*	AGXLB E-840E-Q1170-KB*	3185,00
1170	4000K	On/Off	High	12770lm/104W	10,8	AGXLWE-840H-Q1170-KB*	AGXLB E-840H-Q1170-KB*	3185,00

Opal Flex Diffuser | Direct-Indirect

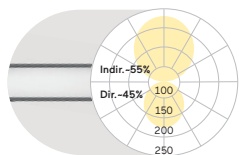

Q mm	Colour Temperature	Control	Power	Lumen/Watt	Weight kg	Code Snow White	Code Jet Black	CHF
640	4000K	On/Off	Low	5230lm/47W	7,0	APXCWE-840E-Q640-K	APXCB E-840E-Q640-K	2328,00
640	4000K	On/Off	Medium	7480lm/69W	7,0	APXCWE-840M-Q640-K	APXCB E-840M-Q640-K	2328,00
900	4000K	On/Off	Low	7880lm/70W	10,2	APXCWE-840E-Q900-K	APXCB E-840E-Q900-K	2660,00
900	4000K	On/Off	Medium	11150lm/101W	10,2	APXCWE-840M-Q900-K	APXCB E-840M-Q900-K	2660,00
1170	4000K	On/Off	Low	10500lm/92W	13,0	APXCWE-840E-Q1170-K	APXCB E-840E-Q1170-K	3115,00
1170	4000K	On/Off	Medium	14870lm/133W	13,0	APXCWE-840M-Q1170-K	APXCB E-840M-Q1170-K	3115,00

Opal Flex Diffuser | Direct

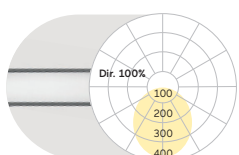

Q mm	Colour Temperature	Control	Power	Lumen/Watt	Weight kg	Code Snow White	Code Jet Black	CHF
640	4000K	On/Off	Medium	3190lm/34W	5,8	AGXCWE-840E-Q640-K	AGXCB E-840E-Q640-K	2100,00
640	4000K	On/Off	High	4460lm/50W	5,8	AGXCWE-840M-Q640-K	AGXCB E-840M-Q640-K	2100,00
900	4000K	On/Off	Medium	4710lm/49W	8,5	AGXCWE-840E-Q900-K	AGXCB E-840E-Q900-K	2363,00
900	4000K	On/Off	High	6630lm/72W	8,5	AGXCWE-840M-Q900-K	AGXCB E-840M-Q900-K	2363,00
1170	4000K	On/Off	Medium	6280lm/64W	10,8	AGXCWE-840E-Q1170-K	AGXCB E-840E-Q1170-K	2713,00
1170	4000K	On/Off	High	8840lm/95W	10,8	AGXCWE-840M-Q1170-K	AGXCB E-840M-Q1170-K	2713,00

Surcharges

Surface Finish	CHF	Control Gear	CHF	Colour Temperature	CHF	Reflector Colour	CHF	Additional Options	CHF
W: Snow White	✓	E: On/Off	✓	22: 2200K	+5%	W: Snow White	✓	Midpin Spotlight XP	+433,00
V: Ivory White	✓	H: Touch-Dim	+172,00	27: 2700K	+5%	A: Satin Silver	✓	Acoustic Absorber	🕒
A: Satin Silver	+15%	L: DALI	+172,00	30: 3000K	✓	B: Jet Black	✓		
S: Radiant Silver	✓	C: Casambi*	+261,00	35: 3500K	+5%	H: Anodic Champagne	✓		
U: Urban Graphite	✓			40: 4000K	✓	G: Satin Gold	✓		
B: Jet Black	✓			65: 6500K	+5%	K: Satin Copper	✓		
H: Anodic Champagne	+10%	*Only in combination with DALI. Please add to dimming price.							
K: Satin Copper	+15%	Colour Rendering	CHF						
R: Special RAL/NCS Colours	🕒	8: CRI>80	✓						
		9: CRI>90	+5%						
		F: Full Spectrum	+15%						

✓ standard / no extra charge 🕒 on request ✗ not available

Caleo Neo G4/P4 | Suspended

catalogue page 276

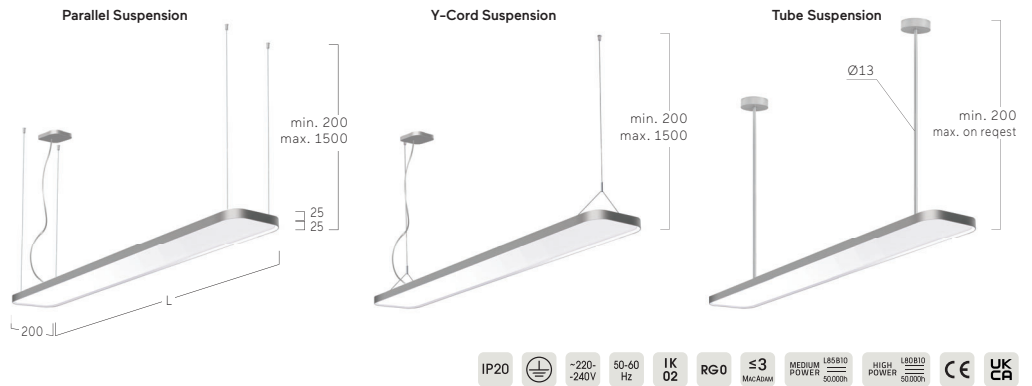

Microprismatic | Direct-Indirect

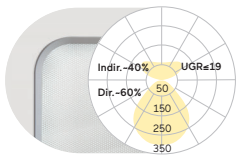

L mm	Colour Temperature	Control	Power	Lumen/Watt	Weight kg	Code Snow White	Code Radiant Silver	CHF
900	4000K	On/Off	Medium	3760lm/31W	3,8	AP4AWE-840M-L900-KW	AP4ASE-840M-L900-KS	917,00
900	4000K	On/Off	High	5070lm/40W	3,8	AP4AWE-840H-L900-KW	AP4ASE-840H-L900-KS	917,00
1200	4000K	On/Off	Medium	5010lm/39W	5,3	AP4AWE-840M-L1200-KW	AP4ASE-840M-L1200-KS	954,00
1200	4000K	On/Off	High	6810lm/52W	5,3	AP4AWE-840H-L1200-KW	AP4ASE-840H-L1200-KS	954,00
1500	4000K	On/Off	Medium	6480lm/49W	6,3	AP4AWE-840M-L1500-KW	AP4ASE-840M-L1500-KS	1147,00
1500	4000K	On/Off	High	8450lm/65W	6,3	AP4AWE-840H-L1500-KW	AP4ASE-840H-L1500-KS	1147,00

Microprismatic | Direct

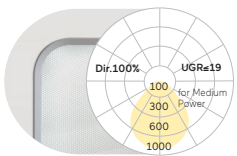

L mm	Colour Temperature	Control	Power	Lumen/Watt	Weight kg	Code Snow White	Code Radiant Silver	CHF
900	4000K	On/Off	Medium	2280lm/19W	3,8	AG4AWE-840M-L900-KW	AG4ASE-840M-L900-KS	833,00
900	4000K	On/Off	High	3150lm/27W	3,8	AG4AWE-840H-L900-KW	AG4ASE-840H-L900-KS	833,00
1200	4000K	On/Off	Medium	3040lm/24W	4,9	AG4AWE-840M-L1200-KW	AG4ASE-840M-L1200-KS	872,00
1200	4000K	On/Off	High	4260lm/34W	4,9	AG4AWE-840H-L1200-KW	AG4ASE-840H-L1200-KS	872,00
1500	4000K	On/Off	Medium	4020lm/32W	5,9	AG4AWE-840M-L1500-KW	AG4ASE-840M-L1500-KS	1019,00
1500	4000K	On/Off	High	5260lm/42W	5,9	AG4AWE-840H-L1500-KW	AG4ASE-840H-L1500-KS	1019,00

Opal Diffuser | Direct-Indirect

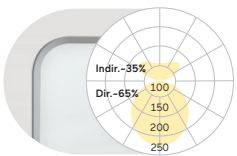

L mm	Colour Temperature	Control	Power	Lumen/Watt	Weight kg	Code Snow White	Code Radiant Silver	CHF
900	4000K	On/Off	Medium	3860lm/31W	3,8	AP4OWE-840M-L900-KW	AP4OSE-840M-L900-KS	900,00
900	4000K	On/Off	High	5210lm/40W	3,8	AP4OWE-840H-L900-KW	AP4OSE-840H-L900-KS	900,00
1200	4000K	On/Off	Medium	5140lm/39W	5,3	AP4OWE-840M-L1200-KW	AP4OSE-840M-L1200-KS	937,00
1200	4000K	On/Off	High	6930lm/52W	5,3	AP4OWE-840H-L1200-KW	AP4OSE-840H-L1200-KS	937,00
1500	4000K	On/Off	Medium	6610lm/49W	6,3	AP4OWE-840M-L1500-KW	AP4OSE-840M-L1500-KS	1108,00
1500	4000K	On/Off	High	8660lm/65W	6,3	AP4OWE-840H-L1500-KW	AP4OSE-840H-L1500-KS	1108,00

Opal Diffuser | Direct

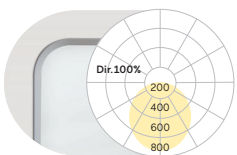

L mm	Colour Temperature	Control	Power	Lumen/Watt	Weight kg	Code Snow White	Code Radiant Silver	CHF
900	4000K	On/Off	Medium	2380lm/19W	3,8	AG4OWE-840M-L900-KW	AG4OSE-840M-L900-KS	816,00
900	4000K	On/Off	High	3290lm/27W	3,8	AG4OWE-840H-L900-KW	AG4OSE-840H-L900-KS	816,00
1200	4000K	On/Off	Medium	3170lm/24W	4,9	AG4OWE-840M-L1200-KW	AG4OSE-840M-L1200-KS	853,00
1200	4000K	On/Off	High	4380lm/34W	4,9	AG4OWE-840H-L1200-KW	AG4OSE-840H-L1200-KS	853,00
1500	4000K	On/Off	Medium	4150lm/32W	5,9	AG4OWE-840M-L1500-KW	AG4OSE-840M-L1500-KS	982,00
1500	4000K	On/Off	High	5470lm/42W	5,9	AG4OWE-840H-L1500-KW	AG4OSE-840H-L1500-KS	982,00

Surcharges

Surface / Reflector Finish

Finish	CHF
Uni-Colours	
W...W: Snow White / Snow White	✓
V...V: Ivory White / Ivory White	✓
S...S: Radiant Silver / Radiant Silver	✓
U...U: Urban Graphite / Urban Graphite	✓
B...B: Jet Black / Jet Black	✓
H...H: Anodic Champ. / Anodic Champ.	+5%
K...K: Satin Copper / Satin Copper	+15%

Surface / Reflector Finish

Finish	CHF
Dual Colours	
W...G: Snow White / Satin Gold	+15%
W...K: Snow White / Satin Copper	+15%
W...B: Snow White / Jet Black	+15%
H...B: Anodic Champ./ Jet Black	+15%
B...G: Jet Black / Satin Gold	+15%
B...W: Jet Black / Snow White	+15%

Control Gear

Control Gear	CHF
E: On/Off	✓
H: Touch-Dim	+86,00
L: DALI	+86,00
C: Casambi*	+261,00

*Only in combination with DALI. Please add to dimming price.

Colour Rendering

Colour Rendering	CHF
8: CRI>80	✓
9: CRI>90	+5%
F: Full Spectrum	+15%

Colour Temperature

Colour Temperature	CHF
22: 2200K	+5%
27: 2700K	+5%
30: 3000K	✓
35: 3500K	+5%
40: 4000K	✓
65: 6500K	+5%

Suspension

Suspension	CHF
K: Parallel Suspension	✓
Y: Y-Cord Suspension	✓
P: Tube Suspension	+86,00

✓ standard / no extra charge ⚠ on request ✗ not available

Caleo Neo G6/P6 | Suspended

catalogue page 280

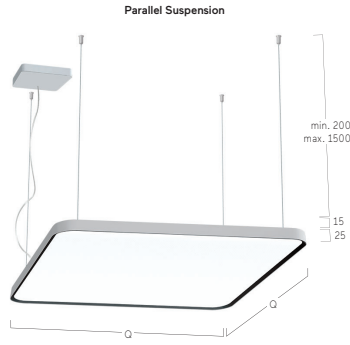

Microprismatic | Direct-Indirect

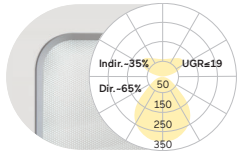

Q mm	Colour Temperature	Control	Power	Lumen/Watt	Weight kg	Code Snow White	Code Radiant Silver	CHF
300	4000K	On/Off	Medium	1990lm/17W	2,0	AP6AWE-840M-Q300-KW	AP6ASE-840M-Q300-KS	856,00
300	4000K	On/Off	High	2700lm/22W	2,0	AP6AWE-840H-Q300-KW	AP6ASE-840H-Q300-KS	856,00
400	4000K	On/Off	Medium	2930lm/23W	3,6	AP6AWE-840M-Q400-KW	AP6ASE-840M-Q400-KS	994,00
400	4000K	On/Off	High	3890lm/31W	3,6	AP6AWE-840H-Q400-KW	AP6ASE-840H-Q400-KS	994,00
500	4000K	On/Off	Medium	5140lm/39W	5,4	AP6AWE-840M-Q500-KW	AP6ASE-840M-Q500-KS	1122,00
500	4000K	On/Off	High	6720lm/52W	5,4	AP6AWE-840H-Q500-KW	AP6ASE-840H-Q500-KS	1122,00
600	4000K	On/Off	Medium	6790lm/54W	7,3	AP6AWE-840M-Q600-KW	AP6ASE-840M-Q600-KS	1278,00
600	4000K	On/Off	High	9230lm/73W	7,3	AP6AWE-840H-Q600-KW	AP6ASE-840H-Q600-KS	1278,00

Microprismatic | Direct

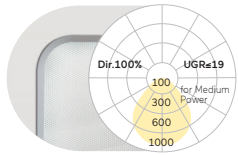

Q mm	Colour Temperature	Control	Power	Lumen/Watt	Weight kg	Code Snow White	Code Radiant Silver	CHF
300	4000K	On/Off	Medium	1230lm/11W	2,0	AG6AWE-840M-Q300-KW	AG6ASE-840M-Q300-KS	739,00
300	4000K	On/Off	High	1670lm/15W	2,0	AG6AWE-840H-Q300-KW	AG6ASE-840H-Q300-KS	739,00
400	4000K	On/Off	Medium	2060lm/18W	3,3	AG6AWE-840M-Q400-KW	AG6ASE-840M-Q400-KS	839,00
400	4000K	On/Off	High	2720lm/23W	3,3	AG6AWE-840H-Q400-KW	AG6ASE-840H-Q400-KS	839,00
500	4000K	On/Off	Medium	3180lm/26W	5,4	AG6AWE-840M-Q500-KW	AG6ASE-840M-Q500-KS	1003,00
500	4000K	On/Off	High	4180lm/35W	5,4	AG6AWE-840H-Q500-KW	AG6ASE-840H-Q500-KS	1003,00
600	4000K	On/Off	Medium	4800lm/39W	7,2	AG6AWE-840M-Q600-KW	AG6ASE-840M-Q600-KS	1122,00
600	4000K	On/Off	High	6480lm/53W	7,2	AG6AWE-840H-Q600-KW	AG6ASE-840H-Q600-KS	1122,00

Opal Diffuser | Direct-Indirect

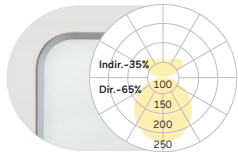

Q mm	Colour Temperature	Control	Power	Lumen/Watt	Weight kg	Code Snow White	Code Radiant Silver	CHF
300	4000K	On/Off	Medium	2000lm/17W	2,0	AP6OWE-840M-Q300-KW	AP6OSE-840M-Q300-KS	839,00
300	4000K	On/Off	High	2720lm/22W	2,0	AP6OWE-840H-Q300-KW	AP6OSE-840H-Q300-KS	839,00
400	4000K	On/Off	Medium	2950lm/23W	3,6	AP6OWE-840M-Q400-KW	AP6OSE-840M-Q400-KS	954,00
400	4000K	On/Off	High	3910lm/31W	3,6	AP6OWE-840H-Q400-KW	AP6OSE-840H-Q400-KS	954,00
500	4000K	On/Off	Medium	5170lm/39W	5,4	AP6OWE-840M-Q500-KW	AP6OSE-840M-Q500-KS	1080,00
500	4000K	On/Off	High	6760lm/52W	5,4	AP6OWE-840H-Q500-KW	AP6OSE-840H-Q500-KS	1080,00
600	4000K	On/Off	Medium	6830lm/54W	7,3	AP6OWE-840M-Q600-KW	AP6OSE-840M-Q600-KS	1220,00
600	4000K	On/Off	High	9290lm/73W	7,3	AP6OWE-840H-Q600-KW	AP6OSE-840H-Q600-KS	1220,00

Opal Diffuser | Direct

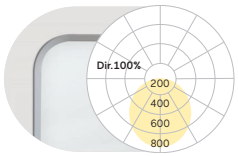

Q mm	Colour Temperature	Control	Power	Lumen/Watt	Weight kg	Code Snow White	Code Radiant Silver	CHF
300	4000K	On/Off	Medium	1240lm/11W	2,0	AG6OWE-840M-Q300-KW	AG6OSE-840M-Q300-KS	721,00
300	4000K	On/Off	High	1690lm/15W	2,0	AG6OWE-840H-Q300-KW	AG6OSE-840H-Q300-KS	721,00
400	4000K	On/Off	Medium	2080lm/18W	3,3	AG6OWE-840M-Q400-KW	AG6OSE-840M-Q400-KS	798,00
400	4000K	On/Off	High	2740lm/23W	3,3	AG6OWE-840H-Q400-KW	AG6OSE-840H-Q400-KS	798,00
500	4000K	On/Off	Medium	3210lm/26W	5,4	AG6OWE-840M-Q500-KW	AG6OSE-840M-Q500-KS	965,00
500	4000K	On/Off	High	4220lm/35W	5,4	AG6OWE-840H-Q500-KW	AG6OSE-840H-Q500-KS	965,00
600	4000K	On/Off	Medium	4840lm/39W	7,2	AG6OWE-840M-Q600-KW	AG6OSE-840M-Q600-KS	1063,00
600	4000K	On/Off	High	6540lm/53W	7,2	AG6OWE-840H-Q600-KW	AG6OSE-840H-Q600-KS	1063,00

Surcharges

Surface / Reflector Finish

Surface / Reflector Finish	CHF
Uni-Colours	
W...W: Snow White / Snow White	✓
V...V: Ivory White / Ivory White	✓
S...S: Radiant Silver / Radiant Silver	✓
U...U: Urban Graphite / Urban Graphite	✓
B...B: Jet Black / Jet Black	✓
H...H: Anodic Champ. / Anodic Champ.	+5%
K...K: Satin Copper / Satin Copper	+15%

Surface / Reflector Finish

Surface / Reflector Finish	CHF
Dual Colours	
W...G: Snow White / Satin Gold	+15%
W...K: Snow White / Satin Copper	+15%
W...B: Snow White / Jet Black	+15%
H...B: Anodic Champ./ Jet Black	+15%
B...G: Jet Black / Satin Gold	+15%
B...W: Jet Black / Snow White	+15%

Control Gear

Control Gear	CHF
E: On/Off	✓
H: Touch-Dim	+86,00
L: DALI	+86,00
C: Casambi*	+261,00

*Only in combination with DALI. Please add to dimming price.

Colour Rendering

Colour Rendering	CHF
8: CRI>80	✓
9: CRI>90	+5%
F: Full Spectrum	+15%

Colour Temperature

Colour Temperature	CHF
22: 2200K	+5%
27: 2700K	+5%
30: 3000K	✓
35: 3500K	+5%
40: 4000K	✓
65: 6500K	+5%

Suspension

Suspension	CHF
K: Parallel Suspension	✓
P: Tube Suspension [Q400-Q600]	+86,00

✓ standard / no extra charge ⚠ on request ✗ not available

Cubic Evolution G4/P4 | 200mm Suspended

catalogue page 284

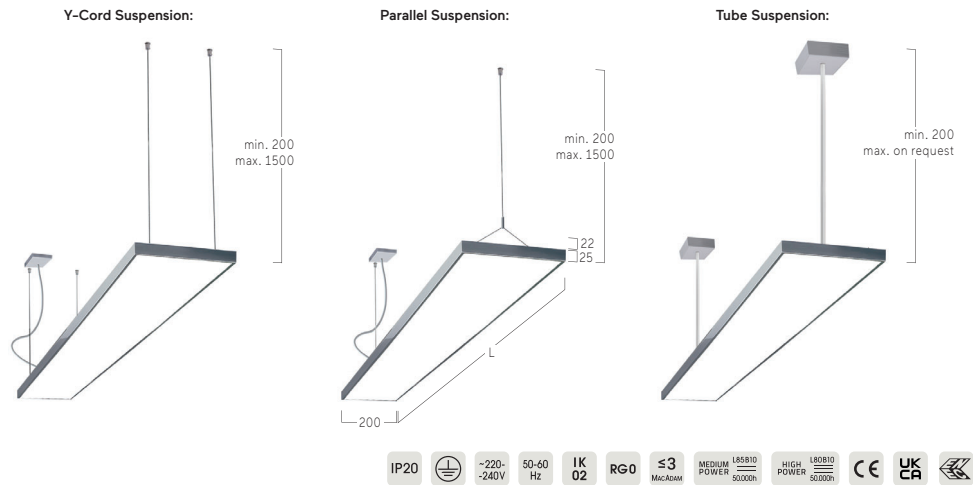

Microprismatic | Direct-Indirect

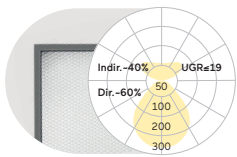

L mm	Colour Temperature	Control	Power	Lumen/Watt	Weight kg	Code Snow White	Code Silver Anodised	CHF
900	4000K	On/Off	Medium	3790lm/30W	3,9	CP4AWE-840M-L900-Y	CP4AEE-840M-L900-Y	839,00
900	4000K	On/Off	High	5000lm/40W	3,9	CP4AWE-840H-L900-Y	CP4AEE-840H-L900-Y	839,00
1200	4000K	On/Off	Medium	5020lm/39W	4,9	CP4AWE-840M-L1200-Y	CP4AEE-840M-L1200-Y	874,00
1200	4000K	On/Off	High	6560lm/52W	4,9	CP4AWE-840H-L1200-Y	CP4AEE-840H-L1200-Y	874,00
1500	4000K	On/Off	Medium	6160lm/48W	6,0	CP4AWE-840M-L1500-Y	CP4AEE-840M-L1500-Y	1049,00
1500	4000K	On/Off	High	8270lm/65W	6,0	CP4AWE-840H-L1500-Y	CP4AEE-840H-L1500-Y	1049,00

Microprismatic | Direct

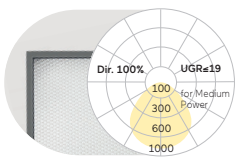

L mm	Colour Temperature	Control	Power	Lumen/Watt	Weight kg	Code Snow White	Code Silver Anodised	CHF
900	4000K	On/Off	Medium	2280lm/21W	4,0	CG4AWE-840M-L900-Y	CG4AEE-840M-L900-Y	786,00
900	4000K	On/Off	High	2930lm/26W	4,0	CG4AWE-840H-L900-Y	CG4AEE-840H-L900-Y	786,00
1200	4000K	On/Off	Medium	3050lm/27W	4,8	CG4AWE-840M-L1200-Y	CG4AEE-840M-L1200-Y	821,00
1200	4000K	On/Off	High	3900lm/34W	4,8	CG4AWE-840H-L1200-Y	CG4AEE-840H-L1200-Y	821,00
1500	4000K	On/Off	Medium	3700lm/32W	5,7	CG4AWE-840M-L1500-Y	CG4AEE-840M-L1500-Y	961,00
1500	4000K	On/Off	High	4880lm/43W	5,7	CG4AWE-840H-L1500-Y	CG4AEE-840H-L1500-Y	961,00

Opal Diffuser | Direct-Indirect

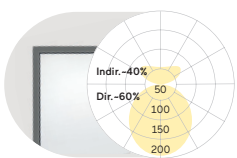

L mm	Colour Temperature	Control	Power	Lumen/Watt	Weight kg	Code Snow White	Code Silver Anodised	CHF
900	4000K	On/Off	Medium	3750lm/30W	3,9	CP4OWE-840M-L900-Y	CP4OEE-840M-L900-Y	821,00
900	4000K	On/Off	High	4950lm/40W	3,9	CP4OWE-840H-L900-Y	CP4OEE-840H-L900-Y	821,00
1200	4000K	On/Off	Medium	4930lm/39W	4,9	CP4OWE-840M-L1200-Y	CP4OEE-840M-L1200-Y	856,00
1200	4000K	On/Off	High	6510lm/52W	4,9	CP4OWE-840H-L1200-Y	CP4OEE-840H-L1200-Y	856,00
1500	4000K	On/Off	Medium	6090lm/48W	6,0	CP4OWE-840M-L1500-Y	CP4OEE-840M-L1500-Y	1014,00
1500	4000K	On/Off	High	8160lm/65W	6,0	CP4OWE-840H-L1500-Y	CP4OEE-840H-L1500-Y	1014,00

Opal Diffuser | Direct

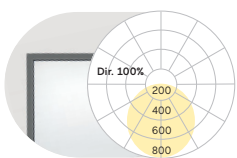

L mm	Colour Temperature	Control	Power	Lumen/Watt	Weight kg	Code Snow White	Code Silver Anodised	CHF
900	4000K	On/Off	Medium	2170lm/21W	4,0	CG4OWE-840M-L900-Y	CG4OEE-840M-L900-Y	769,00
900	4000K	On/Off	High	2730lm/26W	4,0	CG4OWE-840H-L900-Y	CG4OEE-840H-L900-Y	769,00
1200	4000K	On/Off	Medium	2890lm/27W	4,8	CG4OWE-840M-L1200-Y	CG4OEE-840M-L1200-Y	804,00
1200	4000K	On/Off	High	3650lm/34W	4,8	CG4OWE-840H-L1200-Y	CG4OEE-840H-L1200-Y	804,00
1500	4000K	On/Off	Medium	3460lm/32W	5,7	CG4OWE-840M-L1500-Y	CG4OEE-840M-L1500-Y	926,00
1500	4000K	On/Off	High	4560lm/43W	5,7	CG4OWE-840H-L1500-Y	CG4OEE-840H-L1500-Y	926,00

Surcharges

Surface Finish

W: Snow White	✓
E: Silver Anodised	✓
U: Urban Graphite	✓
B: Jet Black	✓
H: Anodic Champagne	+10%
R: Special RAL/NCS Colours	🚫

CHF

Control Gear

E: On/Off	✓
L: DALI	+86,00
H: Touch-Dim	+86,00
C: Casambi*	+261,00
6: DALI DT6 for TW	+172,00
8: DALI DT8 for TW	+172,00

*Only in combination with DALI. Please add to dimming price.

CHF

Colour Rendering

8: CRI>80	✓
9: CRI>90	+5%
F: Full Spectrum	+15%

CHF

Colour Temperature

22: 2200K	+5%
27: 2700K	+5%
30: 3000K	✓
35: 3500K	+5%
40: 4000K	✓
65: 6500K	+5%
TW: Tunable White 2700-6500K*	+30%

*Only in combination with DT6, DT8 or Casambi control. Please add additional control price.

CHF

Suspension

K: Parallel Suspension	✓
Y: Y-Cord Suspension	✓
P: Tube Suspension	+86,00

Additional Options

Emergency Module [DALI, Autotest, incl. 3H Battery] [L1200-L1500]	+366,00
Multisensor	+261,00

CHF

✓ standard / no extra charge 🚫 on request 🚫 not available

Cubic Evolution G5/P5 | 300mm Suspended

catalogue page 286



Parallel Suspension:



Y-Cord Suspension:

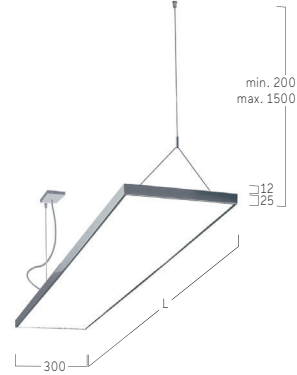

Microprismatic | Direct-Indirect

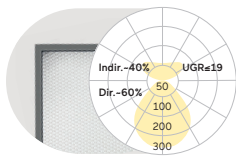

L mm	Colour Temperature	Control	Power	Lumen/Watt	Weight kg	Code Snow White	Code Silver Anodised	CHF
900	4000K	On/Off	Medium	5220lm/39W	7,3	CP5AWE-840M-L900-Y	CP5AEE-840M-L900-Y	1001,00
900	4000K	On/Off	High	7430lm/55W	7,3	CP5AWE-840H-L900-Y	CP5AEE-840H-L900-Y	1001,00
1200	4000K	On/Off	Medium	6990lm/51W	8,0	CP5AWE-840M-L1200-Y	CP5AEE-840M-L1200-Y	1112,00
1200	4000K	On/Off	High	9910lm/74W	8,0	CP5AWE-840H-L1200-Y	CP5AEE-840H-L1200-Y	1112,00
1500	4000K	On/Off	Medium	8590lm/62W	8,8	CP5AWE-840M-L1500-Y	CP5AEE-840M-L1500-Y	1353,00
1500	4000K	On/Off	High	12350lm/91W	8,8	CP5AWE-840H-L1500-Y	CP5AEE-840H-L1500-Y	1353,00

Microprismatic | Direct

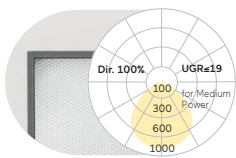

L mm	Colour Temperature	Control	Power	Lumen/Watt	Weight kg	Code Snow White	Code Silver Anodised	CHF
900	4000K	On/Off	Medium	3220lm/25W	5,3	CG5AWE-840M-L900-Y	CG5AEE-840M-L900-Y	926,00
900	4000K	On/Off	High	4600lm/35W	5,3	CG5AWE-840H-L900-Y	CG5AEE-840H-L900-Y	926,00
1200	4000K	On/Off	Medium	4290lm/33W	7,0	CG5AWE-840M-L1200-Y	CG5AEE-840M-L1200-Y	982,00
1200	4000K	On/Off	High	6140lm/48W	7,0	CG5AWE-840H-L1200-Y	CG5AEE-840H-L1200-Y	982,00
1500	4000K	On/Off	Medium	5370lm/40W	8,0	CG5AWE-840M-L1500-Y	CG5AEE-840M-L1500-Y	1187,00
1500	4000K	On/Off	High	7670lm/59W	8,0	CG5AWE-840H-L1500-Y	CG5AEE-840H-L1500-Y	1187,00

Opal Diffuser | Direct-Indirect

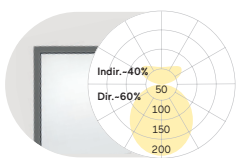

L mm	Colour Temperature	Control	Power	Lumen/Watt	Weight kg	Code Snow White	Code Silver Anodised	CHF
900	4000K	On/Off	Medium	5030lm/39W	7,3	CP5OWE-840M-L900-Y	CP5OEE-840M-L900-Y	965,00
900	4000K	On/Off	High	7140lm/55W	7,3	CP5OWE-840H-L900-Y	CP5OEE-840H-L900-Y	965,00
1200	4000K	On/Off	Medium	6740lm/51W	8,0	CP5OWE-840M-L1200-Y	CP5OEE-840M-L1200-Y	1057,00
1200	4000K	On/Off	High	9510lm/74W	8,0	CP5OWE-840H-L1200-Y	CP5OEE-840H-L1200-Y	1057,00
1500	4000K	On/Off	Medium	8270lm/62W	8,8	CP5OWE-840M-L1500-Y	CP5OEE-840M-L1500-Y	1297,00
1500	4000K	On/Off	High	11850lm/91W	8,8	CP5OWE-840H-L1500-Y	CP5OEE-840H-L1500-Y	1297,00

Opal Diffuser | Direct

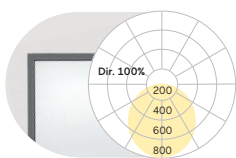

L mm	Colour Temperature	Control	Power	Lumen/Watt	Weight kg	Code Snow White	Code Silver Anodised	CHF
900	4000K	On/Off	Medium	3030lm/25W	5,3	CG5OWE-840M-L900-Y	CG5OEE-840M-L900-Y	889,00
900	4000K	On/Off	High	4310lm/35W	5,3	CG5OWE-840H-L900-Y	CG5OEE-840H-L900-Y	889,00
1200	4000K	On/Off	Medium	4040lm/33W	7,0	CG5OWE-840M-L1200-Y	CG5OEE-840M-L1200-Y	926,00
1200	4000K	On/Off	High	5740lm/48W	7,0	CG5OWE-840H-L1200-Y	CG5OEE-840H-L1200-Y	926,00
1500	4000K	On/Off	Medium	5050lm/40W	8,0	CG5OWE-840M-L1500-Y	CG5OEE-840M-L1500-Y	1131,00
1500	4000K	On/Off	High	7170lm/59W	8,0	CG5OWE-840H-L1500-Y	CG5OEE-840H-L1500-Y	1131,00

Surcharges

Surface Finish	CHF	Control Gear	CHF	Colour Rendering	CHF	Colour Temperature	CHF	Suspension	CHF
W: Snow White	✓	E: On/Off	✓	8: CRI>80	✓	22: 2200K	+5%	K: Parallel Suspension	✓
E: Silver Anodised	✓	L: DALI	+86,00	9: CRI>90	+5%	27: 2700K	+5%	Y: Y-Cord Suspension	✓
U: Urban Graphite	✓	H: Touch-Dim	+86,00	F: Full Spectrum	+15%	30: 3000K	✓		
B: Jet Black	✓	C: Casambi*	+261,00			35: 3500K	+5%	Additional Options	CHF
H: Anodic Champagne	+10%	6: DALI DT6 for TW	+172,00			40: 4000K	✓	Emergency Module [DALI, Autotest, incl. 3H Battery]	+366,00
R: Special RAL/NCS Colours	ⓘ	8: DALI DT8 for TW	+172,00			65: 6500K	+5%	Radar Sensor	+209,00
						TW: Tunable White 2700-6500K*	+30%	Multisensor	+261,00

*Only in combination with DALI. Please add to dimming price.

*Only in combination with DT6, DT8 or Casambi control. Please add additional control price.

✓ standard / no extra charge ⓘ on request ✗ not available

Cubic Evolution G6/P6 | Square Suspended

catalogue page 288

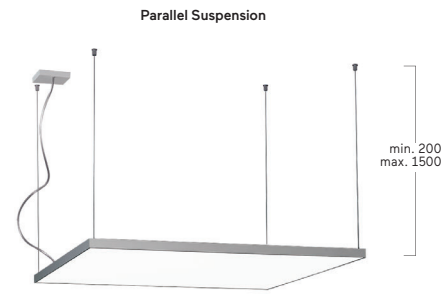
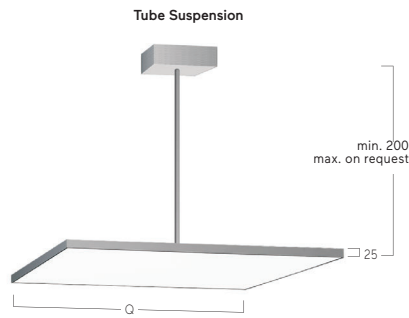

Microprismatic | Direct-Indirect

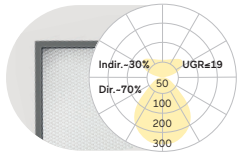

Q mm	Colour Temperature	Control	Power	Lumen/Watt	Weight kg	Code Snow White	Code Silver Anodised	CHF
300	4000K	On/Off	Medium	1970lm/16W	2,5	CP6AWE-840M-Q300-K	CP6AEE-840M-Q300-K	807,00
300	4000K	On/Off	High	2850lm/24W	2,5	CP6AWE-840H-Q300-K	CP6AEE-840H-Q300-K	807,00
400	4000K	On/Off	Medium	2920lm/23W	3,8	CP6AWE-840M-Q400-K	CP6AEE-840M-Q400-K	937,00
400	4000K	On/Off	High	4170lm/32W	3,8	CP6AWE-840H-Q400-K	CP6AEE-840H-Q400-K	937,00
500	4000K	On/Off	Medium	4580lm/33W	5,9	CP6AWE-840M-Q500-K	CP6AEE-840M-Q500-K	1057,00
500	4000K	On/Off	High	5900lm/44W	5,9	CP6AWE-840H-Q500-K	CP6AEE-840H-Q500-K	1057,00
600	4000K	On/Off	Medium	7240lm/55W	7,8	CP6AWE-840M-Q600-K	CP6AEE-840M-Q600-K	1204,00
600	4000K	On/Off	High	9850lm/76W	7,8	CP6AWE-840H-Q600-K	CP6AEE-840H-Q600-K	1204,00
800	4000K	On/Off	Medium	10590lm/76W	9,0	CP6AWE-840M-Q800-K	CP6AEE-840M-Q800-K	2246,00
800	4000K	On/Off	High	14950lm/109W	9,0	CP6AWE-840H-Q800-K	CP6AEE-840H-Q800-K	2246,00

Microprismatic | Direct

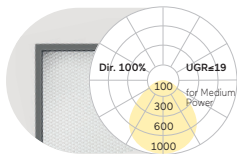

Q mm	Colour Temperature	Control	Power	Lumen/Watt	Weight kg	Code Snow White	Code Silver Anodised	CHF
300	4000K	On/Off	Medium	1210lm/11W	2,5	CG6AWE-840M-Q300-K	CG6AEE-840M-Q300-K	697,00
300	4000K	On/Off	High	1740lm/16W	2,5	CG6AWE-840H-Q300-K	CG6AEE-840H-Q300-K	697,00
400	4000K	On/Off	Medium	1960lm/16W	4,1	CG6AWE-840M-Q400-K	CG6AEE-840M-Q400-K	790,00
400	4000K	On/Off	High	2860lm/24W	4,1	CG6AWE-840H-Q400-K	CG6AEE-840H-Q400-K	790,00
500	4000K	On/Off	Medium	3330lm/26W	5,9	CG6AWE-840M-Q500-K	CG6AEE-840M-Q500-K	945,00
500	4000K	On/Off	High	4290lm/34W	5,9	CG6AWE-840H-Q500-K	CG6AEE-840H-Q500-K	945,00
600	4000K	On/Off	Medium	5250lm/40W	7,7	CG6AWE-840M-Q600-K	CG6AEE-840M-Q600-K	1057,00
600	4000K	On/Off	High	7100lm/55W	7,7	CG6AWE-840H-Q600-K	CG6AEE-840H-Q600-K	1057,00
800	4000K	On/Off	Medium	7590lm/55W	9,0	CG6AWE-840M-Q800-K	CG6AEE-840M-Q800-K	2058,00
800	4000K	On/Off	High	10630lm/78W	9,0	CG6AWE-840H-Q800-K	CG6AEE-840H-Q800-K	2058,00

Opal Diffuser | Direct-Indirect

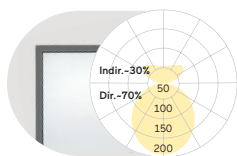

Q mm	Colour Temperature	Control	Power	Lumen/Watt	Weight kg	Code Snow White	Code Silver Anodised	CHF
300	4000K	On/Off	Medium	1930lm/16W	2,5	CP6OWE-840M-Q300-K	CP6OEE-840M-Q300-K	790,00
300	4000K	On/Off	High	2760lm/24W	2,5	CP6OWE-840H-Q300-K	CP6OEE-840H-Q300-K	790,00
400	4000K	On/Off	Medium	2870lm/23W	3,8	CP6OWE-840M-Q400-K	CP6OEE-840M-Q400-K	900,00
400	4000K	On/Off	High	4120lm/32W	3,8	CP6OWE-840H-Q400-K	CP6OEE-840H-Q400-K	900,00
500	4000K	On/Off	Medium	4550lm/33W	5,9	CP6OWE-840M-Q500-K	CP6OEE-840M-Q500-K	1019,00
500	4000K	On/Off	High	5880lm/44W	5,9	CP6OWE-840H-Q500-K	CP6OEE-840H-Q500-K	1019,00
600	4000K	On/Off	Medium	7170lm/55W	7,8	CP6OWE-840M-Q600-K	CP6OEE-840M-Q600-K	1150,00
600	4000K	On/Off	High	9750lm/76W	7,8	CP6OWE-840H-Q600-K	CP6OEE-840H-Q600-K	1150,00
800	4000K	On/Off	Medium	10370lm/76W	9,0	CP6OWE-840M-Q800-K	CP6OEE-840M-Q800-K	2190,00
800	4000K	On/Off	High	14440lm/109W	9,0	CP6OWE-840H-Q800-K	CP6OEE-840H-Q800-K	2190,00

Opal Diffuser | Direct

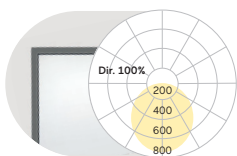

Q mm	Colour Temperature	Control	Power	Lumen/Watt	Weight kg	Code Snow White	Code Silver Anodised	CHF
300	4000K	On/Off	Medium	1170lm/11W	2,5	CG6OWE-840M-Q300-K	CG6OEE-840M-Q300-K	679,00
300	4000K	On/Off	High	1650lm/16W	2,5	CG6OWE-840H-Q300-K	CG6OEE-840H-Q300-K	679,00
400	4000K	On/Off	Medium	1910lm/16W	4,1	CG6OWE-840M-Q400-K	CG6OEE-840M-Q400-K	753,00
400	4000K	On/Off	High	2810lm/24W	4,1	CG6OWE-840H-Q400-K	CG6OEE-840H-Q400-K	753,00
500	4000K	On/Off	Medium	3300lm/26W	5,9	CG6OWE-840M-Q500-K	CG6OEE-840M-Q500-K	909,00
500	4000K	On/Off	High	4270lm/34W	5,9	CG6OWE-840H-Q500-K	CG6OEE-840H-Q500-K	909,00
600	4000K	On/Off	Medium	5180lm/40W	7,7	CG6OWE-840M-Q600-K	CG6OEE-840M-Q600-K	1001,00
600	4000K	On/Off	High	7000lm/55W	7,7	CG6OWE-840H-Q600-K	CG6OEE-840H-Q600-K	1001,00
800	4000K	On/Off	Medium	7370lm/55W	9,0	CG6OWE-840M-Q800-K	CG6OEE-840M-Q800-K	2002,00
800	4000K	On/Off	High	10120lm/78W	9,0	CG6OWE-840H-Q800-K	CG6OEE-840H-Q800-K	2002,00

Surcharges

Surface Finish	CHF	Control Gear	CHF	Colour Rendering	CHF	Colour Temperature	CHF	Suspension	CHF
W: Snow White	✓	E: On/Off	Q300-Q600	8: CRI>80	✓	22: 2200K	+5%	K: Parallel Suspension	✓
E: Silver Anodised	✓	L: DALI	+86,00	9: CRI>90	+5%	27: 2700K	+5%	P: Tube Suspension	+86,00
U: Urban Graphite	✓	H: Touch-Dim	+86,00	F: Full Spectrum	+15%	30: 3000K	✓	[Q400-Q800]	
B: Jet Black	✓	C: Casambi*	+261,00			35: 3500K	+5%	Additional Options	CHF
H: Anodic Champagne	+10%	6: DALI DT6 for TW	+172,00			40: 4000K	✓	Emergency Module	
R: Special RAL/NCS Colours	⚠	8: DALI DT8 for TW	+172,00			65: 6500K	+5%	[DALI, Autotest, incl. 3H Battery]	+366,00
						TW: Tunable White 2700-6500K*	+30%	[Q400-Q800]	
						[Q400-Q800]		Multisensor	+261,00
								[Q400-Q800]	

✓ standard / no extra charge ⚠ on request ✗ not available

Cubic Evolution System G4/P4 | Suspended

catalogue page 290

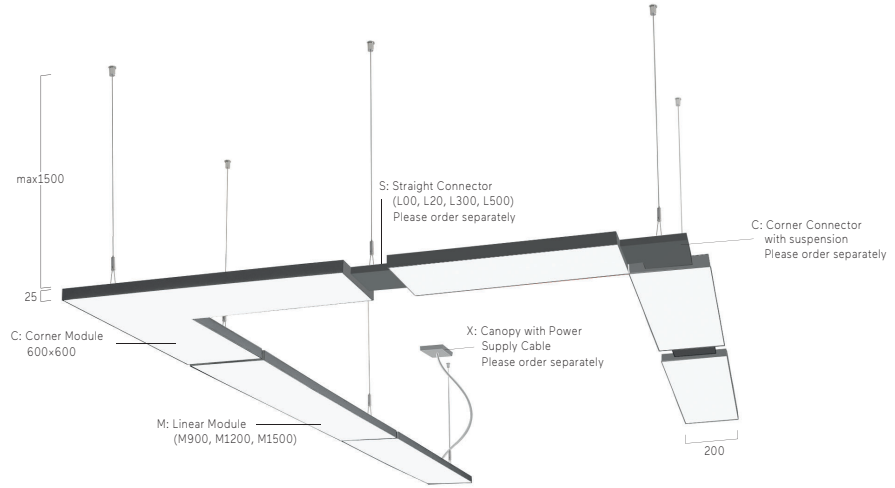

Microprismatic | Direct-Indirect

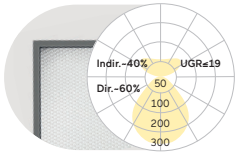

L mm	Colour Temperature	Control	Power	Lumen/Watt	Weight kg	Code Snow White	Code Silver Anodised	CHF
Corner Modules:								
600x600	4000K	On/Off	Medium	4410lm/38W	4,5	CP4AWE-840M-C600-Y	CP4AEE-840M-C600-Y	1225,00
600x600	4000K	On/Off	High	5650lm/48W	4,5	CP4AWE-840H-C600-Y	CP4AEE-840H-C600-Y	1225,00
Linear Modules:								
900	4000K	On/Off	Medium	3790lm/30W	4,3	CP4AWE-840M-M900-Y	CP4AEE-840M-M900-Y	937,00
900	4000K	On/Off	High	5000lm/40W	4,3	CP4AWE-840H-M900-Y	CP4AEE-840H-M900-Y	937,00
1200	4000K	On/Off	Medium	5020lm/39W	5,4	CP4AWE-840M-M1200-Y	CP4AEE-840M-M1200-Y	973,00
1200	4000K	On/Off	High	6560lm/52W	5,4	CP4AWE-840H-M1200-Y	CP4AEE-840H-M1200-Y	973,00
1500	4000K	On/Off	Medium	6160lm/48W	6,2	CP4AWE-840M-M1500-Y	CP4AEE-840M-M1500-Y	1154,00
1500	4000K	On/Off	High	8270lm/65W	6,2	CP4AWE-840H-M1500-Y	CP4AEE-840H-M1500-Y	1154,00

Microprismatic | Direct

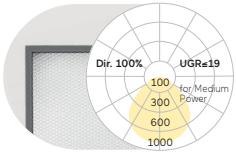

L mm	Colour Temperature	Control	Power	Lumen/Watt	Weight kg	Code Snow White	Code Silver Anodised	CHF
Corner Modules:								
600x600	4000K	On/Off	Medium	2530lm/25W	4,5	CG4AWE-840M-C600-Y	CG4AEE-840M-C600-Y	1101,00
600x600	4000K	On/Off	High	3150lm/31W	4,5	CG4AWE-840H-C600-Y	CG4AEE-840H-C600-Y	1101,00
Linear Modules:								
900	4000K	On/Off	Medium	2280lm/21W	4,0	CG4AWE-840M-M900-Y	CG4AEE-840M-M900-Y	856,00
900	4000K	On/Off	High	2930lm/26W	4,0	CG4AWE-840H-M900-Y	CG4AEE-840H-M900-Y	856,00
1200	4000K	On/Off	Medium	3050lm/27W	4,8	CG4AWE-840M-M1200-Y	CG4AEE-840M-M1200-Y	891,00
1200	4000K	On/Off	High	3900lm/34W	4,8	CG4AWE-840H-M1200-Y	CG4AEE-840H-M1200-Y	891,00
1500	4000K	On/Off	Medium	3700lm/32W	5,7	CG4AWE-840M-M1500-Y	CG4AEE-840M-M1500-Y	1031,00
1500	4000K	On/Off	High	4880lm/43W	5,7	CG4AWE-840H-M1500-Y	CG4AEE-840H-M1500-Y	1031,00

Opal Diffuser | Direct-Indirect

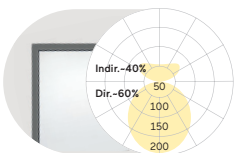

L mm	Colour Temperature	Control	Power	Lumen/Watt	Weight kg	Code Snow White	Code Silver Anodised	CHF
Corner Modules:								
600x600	4000K	On/Off	Medium	4250lm/38W	4,5	CP4OWE-840M-C600-Y	CP4OEE-840M-C600-Y	1171,00
600x600	4000K	On/Off	High	5450lm/48W	4,5	CP4OWE-840H-C600-Y	CP4OEE-840H-C600-Y	1171,00
Linear Modules:								
900	4000K	On/Off	Medium	3750lm/30W	4,3	CP4OWE-840M-M900-Y	CP4OEE-840M-M900-Y	919,00
900	4000K	On/Off	High	4950lm/40W	4,3	CP4OWE-840H-M900-Y	CP4OEE-840H-M900-Y	919,00
1200	4000K	On/Off	Medium	4930lm/39W	5,4	CP4OWE-840M-M1200-Y	CP4OEE-840M-M1200-Y	954,00
1200	4000K	On/Off	High	6510lm/52W	5,4	CP4OWE-840H-M1200-Y	CP4OEE-840H-M1200-Y	954,00
1500	4000K	On/Off	Medium	6090lm/48W	6,2	CP4OWE-840M-M1500-Y	CP4OEE-840M-M1500-Y	1117,00
1500	4000K	On/Off	High	8160lm/65W	6,2	CP4OWE-840H-M1500-Y	CP4OEE-840H-M1500-Y	1117,00

Opal Diffuser | Direct

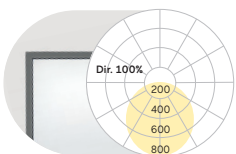

L mm	Colour Temperature	Control	Power	Lumen/Watt	Weight kg	Code Snow White	Code Silver Anodised	CHF
Corner Modules:								
600x600	4000K	On/Off	Medium	2370lm/25W	4,5	CG4OWE-840M-C600-Y	CG4OEE-840M-C600-Y	1049,00
600x600	4000K	On/Off	High	2950lm/31W	4,5	CG4OWE-840H-C600-Y	CG4OEE-840H-C600-Y	1049,00
Linear Modules:								
900	4000K	On/Off	Medium	2170lm/21W	4,0	CG4OWE-840M-M900-Y	CG4OEE-840M-M900-Y	839,00
900	4000K	On/Off	High	2730lm/26W	4,0	CG4OWE-840H-M900-Y	CG4OEE-840H-M900-Y	839,00
1200	4000K	On/Off	Medium	2890lm/27W	4,8	CG4OWE-840M-M1200-Y	CG4OEE-840M-M1200-Y	874,00
1200	4000K	On/Off	High	3650lm/34W	4,8	CG4OWE-840H-M1200-Y	CG4OEE-840H-M1200-Y	874,00
1500	4000K	On/Off	Medium	3460lm/32W	5,7	CG4OWE-840M-M1500-Y	CG4OEE-840M-M1500-Y	996,00
1500	4000K	On/Off	High	4560lm/43W	5,7	CG4OWE-840H-M1500-Y	CG4OEE-840H-M1500-Y	996,00

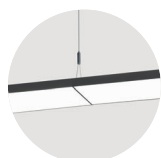

S L00 Edge to Edge Straight Connector with suspension



S L20 Straight Connector 20mm with suspension

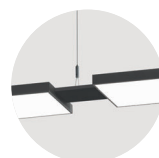

S L300 Straight Connector 300mm with suspension



S L500 Straight Connector 500mm with suspension

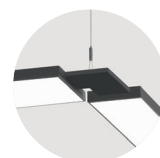

C L170x170 Corner Connector with suspension

... Cubic Evolution System G4/P4 | Suspended

Type	Code Snow White	Code Silver Anodised	CHF
Edge to Edge Straight Connector with suspension	S-CONNECTOR-L00-WY	S-CONNECTOR-L00-EY	51,00
Straight Connector 20mm with suspension	S-CONNECTOR-L20-WY	S-CONNECTOR-L20-EY	69,00
Straight Connector 300mm with suspension	S-CONNECTOR-L300-WY	S-CONNECTOR-L300-EY	86,00
Straight Connector 500mm with suspension	S-CONNECTOR-L500-WY	S-CONNECTOR-L500-EY	104,00
Corner Connector with suspension	C-CORNER-L170X170-WY	C-CORNER-L170X170-EY	132,00

Type	Code Snow White	Code Silver Anodised	CHF
End cap for edge modules	X-ENDCAP-W	X-ENDCAP-E	34,00



Type	Cable Length	Cable Type	Code Snow White	Code Radiant Silver	CHF
Canopy + Power Supply Cable	1500 mm	5X0,75mm ² Transparent Cable	X-CANOPY-W-5	X-CANOPY-S-5	49,00

Surcharges

Surface Finish	CHF	Control Gear	CHF	Colour Rendering	CHF	Colour Temperature	CHF	Suspension	CHF
W: Snow White	✓	E: On/Off	✓	8: CRI>80	✓	22: 2200K	+5%	K: Parallel Suspension	✓
E: Silver Anodised	✓	L: DALI	+86,00	9: CRI>90	+5%	27: 2700K	+5%	Y: Y-Cord Suspension	✓
U: Urban Graphite	✓	H: Touch-Dim	+86,00	F: Full Spectrum	+15%	30: 3000K	✓		
B: Jet Black	✓	C: Casambi*	+261,00			35: 3500K	+5%	Additional Options	CHF
H: Anodic Champagne	+10%	6: DALI DT6 for TW	+172,00			40: 4000K	✓	Multisensor	+261,00
R: Special RAL/NCS Colours	ⓘ	8: DALI DT8 for TW	+172,00			65: 6500K	+5%		
						TW: Tunable White 2700-6500K*	+30%		

*Only in combination with DALI. Please add to dimming price.

*Only in combination with DT6, DT8 or Casambi control. Please add additional control price.

✓ standard / no extra charge ⓘ on request ✗ not available

Cubic Evolution U4 | Suspended

catalogue page 292



Parallel Suspension

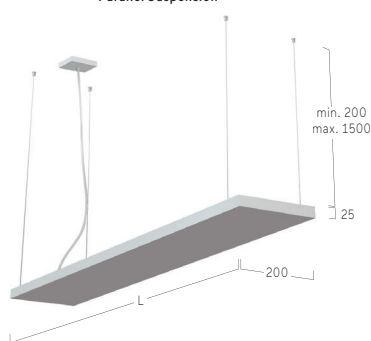

Y-Cord Suspension:



Indirect Optic | Indirect

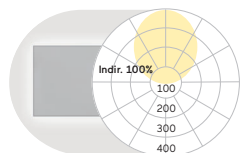

L mm	Colour Temperature	Control	Power	Lumen/Watt	Weight kg	Code Snow White	Code Silver Anodised	CHF
900	4000K	On/Off	Medium	3800lm/28W	3,0	CU4UWE-840M-L900-K	CU4UEE-840M-L900-K	800,00
900	4000K	On/Off	High	5160lm/39W	3,0	CU4UWE-840H-L900-K	CU4UEE-840H-L900-K	800,00
1200	4000K	On/Off	Medium	5070lm/36W	4,0	CU4UWE-840M-L1200-K	CU4UEE-840M-L1200-K	837,00
1200	4000K	On/Off	High	6880lm/51W	4,0	CU4UWE-840H-L1200-K	CU4UEE-840H-L1200-K	837,00
1500	4000K	On/Off	Medium	6340lm/45W	5,0	CU4UWE-840M-L1500-K	CU4UEE-840M-L1500-K	965,00
1500	4000K	On/Off	High	8600lm/63W	5,0	CU4UWE-840H-L1500-K	CU4UEE-840H-L1500-K	965,00
1800	4000K	On/Off	Medium	7600lm/53W	6,0	CU4UWE-840M-L1800-K	CU4UEE-840M-L1800-K	1479,00
1800	4000K	On/Off	High	10320lm/73W	6,0	CU4UWE-840H-L1800-K	CU4UEE-840H-L1800-K	1479,00
2100	4000K	On/Off	Medium	8870lm/61W	7,5	CU4UWE-840M-L2100-K	CU4UEE-840M-L2100-K	1628,00
2100	4000K	On/Off	High	12040lm/85W	7,5	CU4UWE-840H-L2100-K	CU4UEE-840H-L2100-K	1628,00

Surcharges

Surface Finish	CHF	Control Gear	CHF	Colour Rendering	CHF	Colour Temperature	CHF	Additional Options	CHF
W: Snow White	✓	E: On/Off	✓	8: CRI>80	✓	22: 2200K	+5%	3-Phase Track	ⓘ
E: Silver Anodised	✓	H: Touch-Dim	+86,00	9: CRI>90	+5%	27: 2700K	+5%	Midpin Spotlight XM	+363,00
U: Urban Graphite	✓	L: DALI	+86,00	F: Full Spectrum	+15%	30: 3000K	✓	Midpin Downlight XD	+363,00
B: Jet Black	✓					35: 3500K	+5%		
H: Anodic Champagne	+10%					40: 4000K	✓		
R: Special RAL/NCS Colours	ⓘ					65: 6500K	+5%		

✓ standard / no extra charge ⓘ on request ✗ not available

Cubic Max G2/P2 | Suspended

catalogue page 294

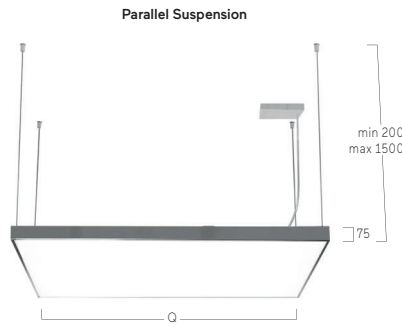

Microprismatic | Direct-Indirect

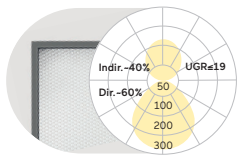

Q mm	Colour Temperature	Control	Power	Lumen/Watt	Weight kg	Code Snow White	Code Silver Anodised	CHF
330	4000K	On/Off	Medium	2470lm/18W	4,2	CP2AWE-840M-Q330-K	CP2AEE-840M-Q330-K	734,00
330	4000K	On/Off	High	3640lm/27W	4,2	CP2AWE-840H-Q330-K	CP2AEE-840H-Q330-K	734,00
430	4000K	On/Off	Medium	4360lm/30W	6,2	CP2AWE-840M-Q430-K	CP2AEE-840M-Q430-K	881,00
430	4000K	On/Off	High	6300lm/44W	6,2	CP2AWE-840H-Q430-K	CP2AEE-840H-Q430-K	881,00
530	4000K	On/Off	Medium	6000lm/42W	8,6	CP2AWE-840M-Q530-K	CP2AEE-840M-Q530-K	973,00
530	4000K	On/Off	High	11170lm/78W	8,6	CP2AWE-840H-Q530-K	CP2AEE-840H-Q530-K	973,00
630	4000K	On/Off	Medium	9610lm/68W	13,0	CP2AWE-840M-Q630-K	CP2AEE-840M-Q630-K	1096,00
630	4000K	On/Off	High	14270lm/103W	13,0	CP2AWE-840H-Q630-K	CP2AEE-840H-Q630-K	1096,00
900	4000K	On/Off	Medium	11660lm/89W	17,0	CP2AWE-840M-Q900-K	CP2AEE-840M-Q900-K	2246,00
900	4000K	On/Off	High	18570lm/161W	17,0	CP2AWE-840H-Q900-K	CP2AEE-840H-Q900-K	2246,00
1200	4000K	On/Off	Medium	19310lm/152W	21,0	CP2AWE-840M-Q1200-K	CP2AEE-840M-Q1200-K	3520,00
1200	4000K	On/Off	High	30990lm/273W	21,0	CP2AWE-840H-Q1200-K	CP2AEE-840H-Q1200-K	3520,00

Microprismatic | Direct

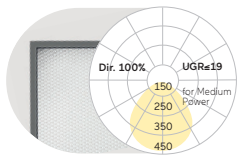

Q mm	Colour Temperature	Control	Power	Lumen/Watt	Weight kg	Code Snow White	Code Silver Anodised	CHF
330	4000K	On/Off	Medium	1360lm/12W	4,2	CG2AWE-840M-Q330-K	CG2AEE-840M-Q330-K	643,00
330	4000K	On/Off	High	2010lm/18W	4,2	CG2AWE-840H-Q330-K	CG2AEE-840H-Q330-K	643,00
430	4000K	On/Off	Medium	2370lm/19W	5,6	CG2AWE-840M-Q430-K	CG2AEE-840M-Q430-K	770,00
430	4000K	On/Off	High	3450lm/27W	5,6	CG2AWE-840H-Q430-K	CG2AEE-840H-Q430-K	770,00
530	4000K	On/Off	Medium	3630lm/27W	8,6	CG2AWE-840M-Q530-K	CG2AEE-840M-Q530-K	881,00
530	4000K	On/Off	High	6790lm/50W	8,6	CG2AWE-840H-Q530-K	CG2AEE-840H-Q530-K	881,00
630	4000K	On/Off	Medium	5200lm/40W	12,4	CG2AWE-840M-Q630-K	CG2AEE-840M-Q630-K	973,00
630	4000K	On/Off	High	8500lm/65W	12,4	CG2AWE-840H-Q630-K	CG2AEE-840H-Q630-K	973,00
900	4000K	On/Off	Medium	7910lm/67W	16,2	CG2AWE-840M-Q900-K	CG2AEE-840M-Q900-K	2058,00
900	4000K	On/Off	High	13240lm/129W	16,2	CG2AWE-840H-Q900-K	CG2AEE-840H-Q900-K	2058,00
1200	4000K	On/Off	Medium	14100lm/122W	26,4	CG2AWE-840M-Q1200-K	CG2AEE-840M-Q1200-K	3276,00
1200	4000K	On/Off	High	23550lm/228W	26,4	CG2AWE-840H-Q1200-K	CG2AEE-840H-Q1200-K	3276,00

Opal Diffuser / Opal Stretch Foil | Direct-Indirect

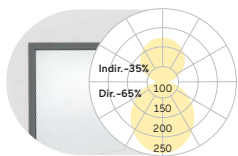

Q mm	Colour Temperature	Control	Power	Lumen/Watt	Weight kg	Code Snow White	Code Silver Anodised	CHF
330	4000K	On/Off	Medium	2510lm/18W	4,2	CP2OWE-840M-Q330-K	CP2OEE-840M-Q330-K	697,00
330	4000K	On/Off	High	3700lm/27W	4,2	CP2OWE-840H-Q330-K	CP2OEE-840H-Q330-K	697,00
430	4000K	On/Off	Medium	4430lm/30W	6,2	CP2OWE-840M-Q430-K	CP2OEE-840M-Q430-K	844,00
430	4000K	On/Off	High	6400lm/44W	6,2	CP2OWE-840H-Q430-K	CP2OEE-840H-Q430-K	844,00
530	4000K	On/Off	Medium	6110lm/42W	8,6	CP2OWE-840M-Q530-K	CP2OEE-840M-Q530-K	917,00
530	4000K	On/Off	High	11370lm/78W	8,6	CP2OWE-840H-Q530-K	CP2OEE-840H-Q530-K	917,00
630	4000K	On/Off	Medium	9770lm/68W	13,0	CP2OWE-840M-Q630-K	CP2OEE-840M-Q630-K	1022,00
630	4000K	On/Off	High	14530lm/103W	13,0	CP2OWE-840H-Q630-K	CP2OEE-840H-Q630-K	1022,00
900	4000K	On/Off	Medium	11900lm/89W	17,0	CP2OWE-840M-Q900-K	CP2OEE-840M-Q900-K	2190,00
900	4000K	On/Off	High	18970lm/161W	17,0	CP2OWE-840H-Q900-K	CP2OEE-840H-Q900-K	2190,00
1200	4000K	On/Off	Medium	19730lm/152W	21,0	CP2OWE-840M-Q1200-K	CP2OEE-840M-Q1200-K	3427,00
1200	4000K	On/Off	High	31700lm/273W	21,0	CP2OWE-840H-Q1200-K	CP2OEE-840H-Q1200-K	3427,00
1500	4000K	On/Off	Medium	30200lm/233W	32,0	CP2TWE-840M-Q1500-K	CP2TEE-840M-Q1500-K	5312,00
1500	4000K	On/Off	High	47570lm/414W	32,0	CP2TWE-840H-Q1500-K	CP2TEE-840H-Q1500-K	5312,00
2000	4000K	On/Off	Medium	41580lm/318W	45,0	CP2TWE-840M-Q2000-K	CP2TEE-840M-Q2000-K	8801,00
2000	4000K	On/Off	High	65800lm/578W	45,0	CP2TWE-840H-Q2000-K	CP2TEE-840H-Q2000-K	8801,00

Opal Diffuser/ Opal Stretch Foil | Direct

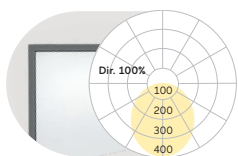

Q mm	Colour Temperature	Control	Power	Lumen/Watt	Weight kg	Code Snow White	Code Silver Anodised	CHF
330	4000K	On/Off	Medium	1400lm/12W	4,2	CG2OWE-840M-Q330-K	CG2OEE-840M-Q330-K	606,00
330	4000K	On/Off	High	2070lm/18W	4,2	CG2OWE-840H-Q330-K	CG2OEE-840H-Q330-K	606,00
430	4000K	On/Off	Medium	2440lm/19W	5,6	CG2OWE-840M-Q430-K	CG2OEE-840M-Q430-K	734,00
430	4000K	On/Off	High	3550lm/27W	5,6	CG2OWE-840H-Q430-K	CG2OEE-840H-Q430-K	734,00
530	4000K	On/Off	Medium	3740lm/27W	8,6	CG2OWE-840M-Q530-K	CG2OEE-840M-Q530-K	826,00
530	4000K	On/Off	High	6990lm/50W	8,6	CG2OWE-840H-Q530-K	CG2OEE-840H-Q530-K	826,00
630	4000K	On/Off	Medium	5360lm/40W	12,4	CG2OWE-840M-Q630-K	CG2OEE-840M-Q630-K	898,00
630	4000K	On/Off	High	8760lm/65W	12,4	CG2OWE-840H-Q630-K	CG2OEE-840H-Q630-K	898,00
900	4000K	On/Off	Medium	8150lm/67W	16,2	CG2OWE-840M-Q900-K	CG2OEE-840M-Q900-K	2002,00
900	4000K	On/Off	High	13640lm/129W	16,2	CG2OWE-840H-Q900-K	CG2OEE-840H-Q900-K	2002,00
1200	4000K	On/Off	Medium	14520lm/122W	26,4	CG2OWE-840M-Q1200-K	CG2OEE-840M-Q1200-K	3182,00
1200	4000K	On/Off	High	24260lm/228W	26,4	CG2OWE-840H-Q1200-K	CG2OEE-840H-Q1200-K	3182,00
1500	4000K	On/Off	Medium	21170lm/189W	32,0	CG2TWE-840M-Q1500-K	CG2TEE-840M-Q1500-K	5035,00
1500	4000K	On/Off	High	34990lm/356W	32,0	CG2TWE-840H-Q1500-K	CG2TEE-840H-Q1500-K	5035,00
2000	4000K	On/Off	Medium	30490lm/268W	45,0	CG2TWE-840M-Q2000-K	CG2TEE-840M-Q2000-K	8250,00
2000	4000K	On/Off	High	50380lm/510W	45,0	CG2TWE-840H-Q2000-K	CG2TEE-840H-Q2000-K	8250,00

Surcharges												
Surface Finish	CHF	Control Gear	CHF	CHF	CHF	Colour Rendering	CHF	Colour Temperature	CHF	Additional Options	CHF	
W: Snow White	✓	E: On/Off	✓	Q330-630	Q900-1200	Q1500-2000	8: CRI>80	✓	22: 2200K	+5%	Emergency Module [DALI, Autotest, incl. 3H Battery] [Q430-Q1200]	+366,00
E: Silver Anodised	✓	L: DALI	+86,00	+172,00	+343,00	9: CRI>90	+5%	27: 2700K	+5%	Multisensor [Q430-Q1200]	+261,00	
U: Urban Graphite	✓	H: Touch-Dim	+86,00	+172,00	+343,00	F: Full Spectrum	+15%	30: 3000K	✓			
B: Jet Black	✓	C: Casambi*	+261,00	+261,00	+261,00			35: 3500K	+5%			
H: Anodic Champagne	+10%	6: DALI DT6 for TW	+172,00	+343,00	+261,00			40: 4000K	✓			
R: Special RAL/NCS Colours	🔔	8: DALI DT8 for TW	+172,00	+343,00	✗			65: 6500K	+5%			
								TW: Tunable White 2700-6500K* [Q330-Q1200]	+30%			

*Only in combination with DALI. Please add to dimming price.

*Only in combination with DT6, DT8 or Casambi control. Please add additional control price.

✓ standard / no extra charge 🔔 on request ✗ not available

Cubic Ambient G7/P7 | Suspended

catalogue page 296



Parallel Suspension

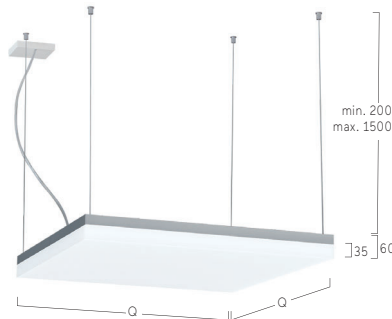

Ambient Diffuser | Direct-Indirect

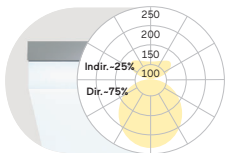

Q mm	Colour Temperature	Control	Power	Lumen/Watt	Weight kg	Code Snow White	Code Radiant Silver	CHF
300	4000K	On/Off	Medium	2110lm/17W	4,0	CP7FWE-840M-Q300-K	CP7FSE-840M-Q300-K	790,00
300	4000K	On/Off	High	3050lm/23W	4,0	CP7FWE-840H-Q300-K	CP7FSE-840H-Q300-K	790,00
400	4000K	On/Off	Medium	3950lm/28W	6,0	CP7FWE-840M-Q400-K	CP7FSE-840M-Q400-K	900,00
400	4000K	On/Off	High	5190lm/36W	6,0	CP7FWE-840H-Q400-K	CP7FSE-840H-Q400-K	900,00
500	4000K	On/Off	Medium	5840lm/41W	8,0	CP7FWE-840M-Q500-K	CP7FSE-840M-Q500-K	1010,00
500	4000K	On/Off	High	8480lm/59W	8,0	CP7FWE-840H-Q500-K	CP7FSE-840H-Q500-K	1010,00
600	4000K	On/Off	Medium	8400lm/58W	12,5	CP7FWE-840M-Q600-K	CP7FSE-840M-Q600-K	1161,00
600	4000K	On/Off	High	11290lm/78W	12,5	CP7FWE-840H-Q600-K	CP7FSE-840H-Q600-K	1161,00

Ambient Diffuser | Direct

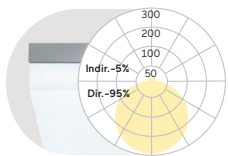

Q mm	Colour Temperature	Control	Power	Lumen/Watt	Weight kg	Code Snow White	Code Radiant Silver	CHF
300	4000K	On/Off	Medium	1480lm/12W	4,0	CG7FWE-840M-Q300-K	CG7FSE-840M-Q300-K	679,00
300	4000K	On/Off	High	2150lm/15W	4,0	CG7FWE-840H-Q300-K	CG7FSE-840H-Q300-K	679,00
400	4000K	On/Off	Medium	2950lm/21W	6,0	CG7FWE-840M-Q400-K	CG7FSE-840M-Q400-K	753,00
400	4000K	On/Off	High	3880lm/27W	6,0	CG7FWE-840H-Q400-K	CG7FSE-840H-Q400-K	753,00
500	4000K	On/Off	Medium	4410lm/30W	8,0	CG7FWE-840M-Q500-K	CG7FSE-840M-Q500-K	900,00
500	4000K	On/Off	High	6520lm/43W	8,0	CG7FWE-840H-Q500-K	CG7FSE-840H-Q500-K	900,00
600	4000K	On/Off	Medium	5650lm/38W	12,5	CG7FWE-840M-Q600-K	CG7FSE-840M-Q600-K	1010,00
600	4000K	On/Off	High	8540lm/58W	12,5	CG7FWE-840H-Q600-K	CG7FSE-840H-Q600-K	1010,00

Surcharges										
Surface Finish	CHF	Control Gear	CHF	Colour Rendering	CHF	Colour Temperature	CHF	Additional Options	CHF	
W: Snow White	✓	E: On/Off	✓	8: CRI>80	✓	22: 2200K	+5%	Emergency Module [DALI, Autotest, incl. 3H Battery] [Q400-Q600]	+366,00	
S: Radiant Silver	✓	H: Touch-Dim	+86,00	9: CRI>90	+5%	27: 2700K	+5%	Radar Sensor	+209,00	
U: Urban Graphite	✓	L: DALI	+86,00	F: Full Spectrum	+15%	30: 3000K	✓			
B: Jet Black	✓	C: Casambi*	+261,00			35: 3500K	+5%			
H: Anodic Champagne	+10%					40: 4000K	✓			
R: Special RAL/NCS Colours	🔔					65: 6500K	+5%			

*Only in combination with DALI. Please add to dimming price.

✓ standard / no extra charge 🔔 on request ✗ not available

Cubic Déco G3/P3 | Suspended

catalogue page 298

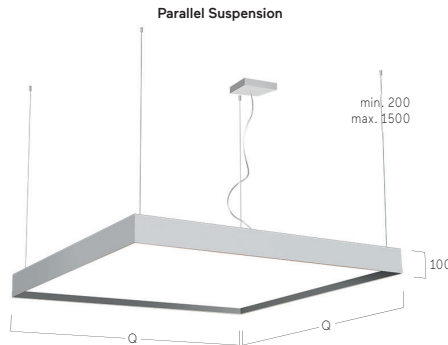

Microprismatic | Direct-Indirect

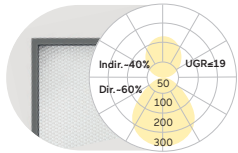

Q mm	Colour Temperature	Control	Power	Lumen/Watt	Weight kg	Code Snow White	Code Radiant Silver	CHF
330	4000K	On/Off	Medium	2470lm/18W	4,5	CP3AWE-840M-Q330-KW	CP3ASE-840M-Q330-KS	847,00
330	4000K	On/Off	High	3640lm/27W	4,5	CP3AWE-840H-Q330-KW	CP3ASE-840H-Q330-KS	847,00
430	4000K	On/Off	Medium	4360lm/30W	6,6	CP3AWE-840M-Q430-KW	CP3ASE-840M-Q430-KS	973,00
430	4000K	On/Off	High	6300lm/44W	6,6	CP3AWE-840H-Q430-KW	CP3ASE-840H-Q430-KS	973,00
530	4000K	On/Off	Medium	6000lm/42W	9,1	CP3AWE-840M-Q530-KW	CP3ASE-840M-Q530-KS	1155,00
530	4000K	On/Off	High	11170lm/78W	9,1	CP3AWE-840H-Q530-KW	CP3ASE-840H-Q530-KS	1155,00
630	4000K	On/Off	Medium	9610lm/68W	13,6	CP3AWE-840M-Q630-KW	CP3ASE-840M-Q630-KS	1318,00
630	4000K	On/Off	High	14270lm/103W	13,6	CP3AWE-840H-Q630-KW	CP3ASE-840H-Q630-KS	1318,00
900	4000K	On/Off	Medium	11660lm/89W	17,8	CP3AWE-840M-Q900-KW	CP3ASE-840M-Q900-KS	2547,00
900	4000K	On/Off	High	18570lm/161W	17,8	CP3AWE-840H-Q900-KW	CP3ASE-840H-Q900-KS	2547,00
1200	4000K	On/Off	Medium	19310lm/152W	22,1	CP3AWE-840M-Q1200-KW	CP3ASE-840M-Q1200-KS	3777,00
1200	4000K	On/Off	High	30990lm/273W	22,1	CP3AWE-840H-Q1200-KW	CP3ASE-840H-Q1200-KS	3777,00

Microprismatic | Direct

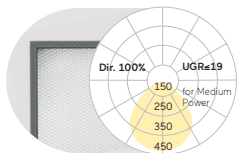

Q mm	Colour Temperature	Control	Power	Lumen/Watt	Weight kg	Code Snow White	Code Radiant Silver	CHF
330	4000K	On/Off	Medium	1360lm/12W	4,5	CG3AWE-840M-Q330-KW	CG3ASE-840M-Q330-KS	707,00
330	4000K	On/Off	High	2010lm/18W	4,5	CG3AWE-840H-Q330-KW	CG3ASE-840H-Q330-KS	707,00
430	4000K	On/Off	Medium	2370lm/19W	6,0	CG3AWE-840M-Q430-KW	CG3ASE-840M-Q430-KS	816,00
430	4000K	On/Off	High	3450lm/27W	6,0	CG3AWE-840H-Q430-KW	CG3ASE-840H-Q430-KS	816,00
530	4000K	On/Off	Medium	3630lm/27W	9,1	CG3AWE-840M-Q530-KW	CG3ASE-840M-Q530-KS	980,00
530	4000K	On/Off	High	6790lm/50W	9,1	CG3AWE-840H-Q530-KW	CG3ASE-840H-Q530-KS	980,00
630	4000K	On/Off	Medium	5200lm/40W	13,0	CG3AWE-840M-Q630-KW	CG3ASE-840M-Q630-KS	1126,00
630	4000K	On/Off	High	8500lm/65W	13,0	CG3AWE-840H-Q630-KW	CG3ASE-840H-Q630-KS	1126,00
900	4000K	On/Off	Medium	7910lm/67W	17,0	CG3AWE-840M-Q900-KW	CG3ASE-840M-Q900-KS	2284,00
900	4000K	On/Off	High	13240lm/129W	17,0	CG3AWE-840H-Q900-KW	CG3ASE-840H-Q900-KS	2284,00
1200	4000K	On/Off	Medium	14100lm/122W	22,1	CG3AWE-840M-Q1200-KW	CG3ASE-840M-Q1200-KS	3427,00
1200	4000K	On/Off	High	23550lm/228W	22,1	CG3AWE-840H-Q1200-KW	CG3ASE-840H-Q1200-KS	3427,00

Opal Diffuser | Direct-Indirect

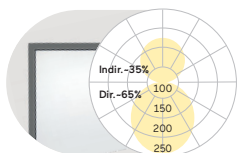

Q mm	Colour Temperature	Control	Power	Lumen/Watt	Weight kg	Code Snow White	Code Radiant Silver	CHF
330	4000K	On/Off	Medium	2510lm/18W	4,5	CP3OWE-840M-Q330-KW	CP3OSE-840M-Q330-KS	755,00
330	4000K	On/Off	High	3700lm/27W	4,5	CP3OWE-840H-Q330-KW	CP3OSE-840H-Q330-KS	755,00
430	4000K	On/Off	Medium	4430lm/30W	6,6	CP3OWE-840M-Q430-KW	CP3OSE-840M-Q430-KS	882,00
430	4000K	On/Off	High	6400lm/44W	6,6	CP3OWE-840H-Q430-KW	CP3OSE-840H-Q430-KS	882,00
530	4000K	On/Off	Medium	6110lm/42W	9,1	CP3OWE-840M-Q530-KW	CP3OSE-840M-Q530-KS	1101,00
530	4000K	On/Off	High	11370lm/78W	9,1	CP3OWE-840H-Q530-KW	CP3OSE-840H-Q530-KS	1101,00
630	4000K	On/Off	Medium	9770lm/68W	13,6	CP3OWE-840M-Q630-KW	CP3OSE-840M-Q630-KS	1262,00
630	4000K	On/Off	High	14530lm/103W	13,6	CP3OWE-840H-Q630-KW	CP3OSE-840H-Q630-KS	1262,00
900	4000K	On/Off	Medium	11900lm/89W	17,8	CP3OWE-840M-Q900-KW	CP3OSE-840M-Q900-KS	2454,00
900	4000K	On/Off	High	18970lm/161W	17,8	CP3OWE-840H-Q900-KW	CP3OSE-840H-Q900-KS	2454,00
1200	4000K	On/Off	Medium	19730lm/152W	22,1	CP3OWE-840M-Q1200-KW	CP3OSE-840M-Q1200-KS	3646,00
1200	4000K	On/Off	High	31700lm/273W	22,1	CP3OWE-840H-Q1200-KW	CP3OSE-840H-Q1200-KS	3646,00

Opal Diffuser | Direct

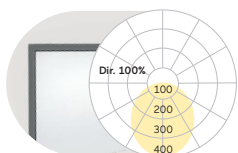

Q mm	Colour Temperature	Control	Power	Lumen/Watt	Weight kg	Code Snow White	Code Radiant Silver	CHF
330	4000K	On/Off	Medium	1400lm/12W	4,5	CG3OWE-840M-Q330-KW	CG3OSE-840M-Q330-KS	615,00
330	4000K	On/Off	High	2070lm/18W	4,5	CG3OWE-840H-Q330-KW	CG3OSE-840H-Q330-KS	615,00
430	4000K	On/Off	Medium	2440lm/19W	6,0	CG3OWE-840M-Q430-KW	CG3OSE-840M-Q430-KS	725,00
430	4000K	On/Off	High	3550lm/27W	6,0	CG3OWE-840H-Q430-KW	CG3OSE-840H-Q430-KS	725,00
530	4000K	On/Off	Medium	3740lm/27W	9,1	CG3OWE-840M-Q530-KW	CG3OSE-840M-Q530-KS	926,00
530	4000K	On/Off	High	6990lm/50W	9,1	CG3OWE-840H-Q530-KW	CG3OSE-840H-Q530-KS	926,00
630	4000K	On/Off	Medium	5360lm/40W	13,0	CG3OWE-840M-Q630-KW	CG3OSE-840M-Q630-KS	1070,00
630	4000K	On/Off	High	8760lm/65W	13,0	CG3OWE-840H-Q630-KW	CG3OSE-840H-Q630-KS	1070,00
900	4000K	On/Off	Medium	8150lm/67W	17,0	CG3OWE-840M-Q900-KW	CG3OSE-840M-Q900-KS	2191,00
900	4000K	On/Off	High	13640lm/129W	17,0	CG3OWE-840H-Q900-KW	CG3OSE-840H-Q900-KS	2191,00
1200	4000K	On/Off	Medium	14520lm/122W	22,1	CG3OWE-840M-Q1200-KW	CG3OSE-840M-Q1200-KS	3296,00
1200	4000K	On/Off	High	24260lm/228W	22,1	CG3OWE-840H-Q1200-KW	CG3OSE-840H-Q1200-KS	3296,00

... Cubic Déco G3/P3 | Suspended

Surcharges

Surface / Reflector Finish

Surface / Reflector Finish	CHF
Uni-Colours	
W...W: Snow White / Snow White	✓
V...V: Ivory White / Ivory White	✓
S...S: Radiant Silver / Radiant Silver	✓
U...U: Urban Graphite / Urban Graphite	✓
B...B: Jet Black / Jet Black	✓
H...H: Anodic Champ. / Anodic Champ.	+5%
K...K: Satin Copper / Satin Copper	+15%

Surface / Reflector Finish

Surface / Reflector Finish	CHF
Dual Colours	
W...G: Snow White / Satin Gold	+15%
W...K: Snow White / Satin Copper	+15%
W...B: Snow White / Jet Black	+15%
H...B: Anodic Champ. / Jet Black	+15%
B...G: Jet Black / Satin Gold	+15%
B...W: Jet Black / Snow White	+15%

Control Gear

Control Gear	CHF	CHF
Q300-Q600 Q900-Q1200		
E: On/Off	✓	✓
L: DALI	+86,00	+172,00
H: Touch-Dim	+86,00	+172,00
C: Casambi*	+261,00	+261,00
6: DALI DT6 for TW	+172,00	+261,00
8: DALI DT8 for TW	+172,00	+261,00

*Only in combination with DALI. Please add to dimming price.

Colour Rendering

Colour Rendering	CHF
8: CRI>80	✓
9: CRI>90	+5%
F: Full Spectrum	+15%

Colour Temperature

Colour Temperature	CHF
22: 2200K	+5%
27: 2700K	+5%
30: 3000K	✓
35: 3500K	+5%
40: 4000K	✓
65: 6500K	+5%
TW: Tunable White 2700-6500K* [Q430-Q1200]	+30%

*Only in combination with DT6, DT8 or Casambi control. Please add additional control price.

Additional Options

Additional Options	CHF
Radars Sensor	+209,00
Emergency Module [DALI, Autotest, incl. 3H Battery] [Q430-Q1200]	+366,00

✓ standard / no extra charge ⚡ on request ✗ not available

Matric Déco G9/R9 | Suspended

catalogue page 300

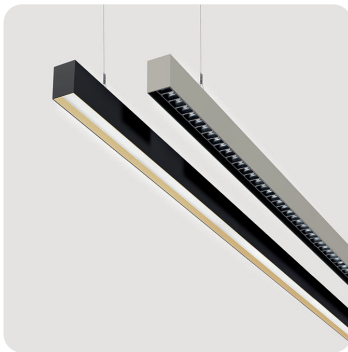

Y-Cord Suspension



Lens Louvre | Direct-Indirect

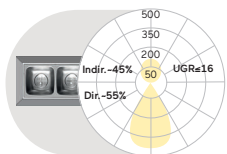

L mm	Colour Temperature	Control	Power	Lumen/Watt	Weight kg	Code Snow White/Snow White	Code Jet Black/Jet Black	CHF
945	4000K	On/Off	Low	2760lm/24W	4,9	LR9LWE-840E-L945-YW	LR9LBE-840E-L945-YB	874,00
945	4000K	On/Off	High	5020lm/43W	4,9	LR9LWE-840H-L945-YW	LR9LBE-840H-L945-YB	874,00
1209	4000K	On/Off	Low	3480lm/29W	5,8	LR9LWE-840E-L1209-YW	LR9LBE-840E-L1209-YB	1014,00
1209	4000K	On/Off	High	6320lm/53W	5,8	LR9LWE-840H-L1209-YW	LR9LBE-840H-L1209-YB	1014,00
1474	4000K	On/Off	Low	4320lm/35W	6,9	LR9LWE-840E-L1474-YW	LR9LBE-840E-L1474-YB	1199,00
1474	4000K	On/Off	High	7860lm/65W	6,9	LR9LWE-840H-L1474-YW	LR9LBE-840H-L1474-YB	1199,00
1738	4000K	On/Off	Low	5180lm/41W	7,9	LR9LWE-840E-L1738-YW	LR9LBE-840E-L1738-YB	1409,00
1738	4000K	On/Off	High	9400lm/76W	7,9	LR9LWE-840H-L1738-YW	LR9LBE-840H-L1738-YB	1409,00
2002	4000K	On/Off	Low	5880lm/46W	9,4	LR9LWE-840E-L2002-YW	LR9LBE-840E-L2002-YB	1672,00
2002	4000K	On/Off	High	10700lm/86W	9,4	LR9LWE-840H-L2002-YW	LR9LBE-840H-L2002-YB	1672,00
per meter	4000K	On/Off	Low	3020lm/23,3W	5,2	LR9LWE-840E-L****-YW	LR9LBE-840E-L****-YB	814,00
per meter	4000K	On/Off	High	5470lm/43,8W	5,2	LR9LWE-840H-L****-YW	LR9LBE-840H-L****-YB	814,00
per meter	4000K	DALI	Low	3020lm/23,3W	5,2	LR9LWL-840E-L****-YW	LR9LBE-840E-L****-YB	884,00
per meter	4000K	DALI	High	5470lm/43,8W	5,2	LR9LWL-840H-L****-YW	LR9LBE-840H-L****-YB	884,00

Lens Louvre | Direct

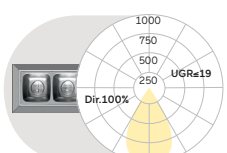

L mm	Colour Temperature	Control	Power	Lumen/Watt	Weight kg	Code Snow White/Snow White	Code Jet Black/Jet Black	CHF
945	4000K	On/Off	Low	1520lm/13W	3,1	LG9LWE-840E-L945-YW	LG9LBE-840E-L945-YB	716,00
945	4000K	On/Off	High	2790lm/24W	3,1	LG9LWE-840H-L945-YW	LG9LBE-840H-L945-YB	716,00
1209	4000K	On/Off	Low	1960lm/16W	3,7	LG9LWE-840E-L1209-YW	LG9LBE-840E-L1209-YB	821,00
1209	4000K	On/Off	High	3590lm/30W	3,7	LG9LWE-840H-L1209-YW	LG9LBE-840H-L1209-YB	821,00
1474	4000K	On/Off	Low	2390lm/19W	4,4	LG9LWE-840E-L1474-YW	LG9LBE-840E-L1474-YB	972,00
1474	4000K	On/Off	High	4390lm/37W	4,4	LG9LWE-840H-L1474-YW	LG9LBE-840H-L1474-YB	972,00
1738	4000K	On/Off	Low	2830lm/23W	5,0	LG9LWE-840E-L1738-YW	LG9LBE-840E-L1738-YB	1164,00
1738	4000K	On/Off	High	5190lm/43W	5,0	LG9LWE-840H-L1738-YW	LG9LBE-840H-L1738-YB	1164,00
2002	4000K	On/Off	Low	3260lm/26W	5,9	LG9LWE-840E-L2002-YW	LG9LBE-840E-L2002-YB	1400,00
2002	4000K	On/Off	High	5990lm/49W	5,9	LG9LWE-840H-L2002-YW	LG9LBE-840H-L2002-YB	1400,00
per meter	4000K	On/Off	Low	1650lm/12,5W	3,2	LG9LWE-840E-L****-YW	LG9LBE-840E-L****-YB	700,00
per meter	4000K	On/Off	High	3020lm/24,1W	3,2	LG9LWE-840H-L****-YW	LG9LBE-840H-L****-YB	700,00
per meter	4000K	DALI	Low	1650lm/12,5W	3,2	LG9LWL-840E-L****-YW	LG9LBE-840E-L****-YB	753,00
per meter	4000K	DALI	High	3020lm/24,1W	3,2	LG9LWL-840H-L****-YW	LG9LBE-840H-L****-YB	753,00

**** Your length in mm

Meterpreise für Lichtsysteme nach Maß ab Mindestlänge 2200mm | Prices per metre for customised lighting systems with a minimum length of 2200mm
Prix au mètre pour systèmes d'éclairage sur mesure à partir d'une longueur minimale de 2200mm

Microprismatic | Direct-Indirect

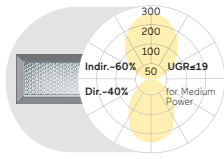

L mm	Colour Temperature	Control	Power	Lumen/Watt	Weight kg	Code Snow White/Snow White	Code Jet Black/Jet Black	CHF
890	4000K	On/Off	Medium	2650lm/26W	4,5	LR9AWE-840M-L890-YW	LR9ABE-840M-L890-YB	804,00
890	4000K	On/Off	High	3470lm/33W	4,5	LR9AWE-840H-L890-YW	LR9ABE-840H-L890-YB	804,00
1182	4000K	On/Off	Medium	3590lm/33W	5,5	LR9AWE-840M-L1182-YW	LR9ABE-840M-L1182-YB	874,00
1182	4000K	On/Off	High	4720lm/44W	5,5	LR9AWE-840H-L1182-YW	LR9ABE-840H-L1182-YB	874,00
1475	4000K	On/Off	Medium	4540lm/41W	6,6	LR9AWE-840M-L1475-YW	LR9ABE-840M-L1475-YB	1014,00
1475	4000K	On/Off	High	5950lm/54W	6,6	LR9AWE-840H-L1475-YW	LR9ABE-840H-L1475-YB	1014,00
1765	4000K	On/Off	Medium	5480lm/48W	7,6	LR9AWE-840M-L1765-YW	LR9ABE-840M-L1765-YB	1224,00
1765	4000K	On/Off	High	7190lm/64W	7,6	LR9AWE-840H-L1765-YW	LR9ABE-840H-L1765-YB	1224,00
2055	4000K	On/Off	Medium	6440lm/59W	9,1	LR9AWE-840M-L2055-YW	LR9ABE-840M-L2055-YB	1462,00
2055	4000K	On/Off	High	8440lm/78W	9,1	LR9AWE-840H-L2055-YW	LR9ABE-840H-L2055-YB	1462,00
per meter	4000K	On/Off	Medium	3110lm/27,2W	4,9	LR9AWE-840M-L****-YW	LR9ABE-840M-L****-YB	709,00
per meter	4000K	On/Off	High	4080lm/36,1W	4,9	LR9AWE-840H-L****-YW	LR9ABE-840H-L****-YB	709,00
per meter	4000K	DALI	Medium	3110lm/27,2W	4,9	LR9AWL-840M-L****-YW	LR9ABL-840M-L****-YB	779,00
per meter	4000K	DALI	High	4080lm/36,1W	4,9	LR9AWL-840H-L****-YW	LR9ABL-840H-L****-YB	779,00

Microprismatic | Direct

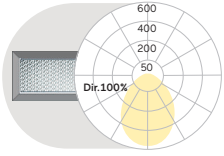

L mm	Colour Temperature	Control	Power	Lumen/Watt	Weight kg	Code Snow White/Snow White	Code Jet Black/Jet Black	CHF
890	4000K	On/Off	Low	830lm/10W	2,8	LG9AWE-840E-L890-YW	LG9ABE-840E-L890-YB	576,00
890	4000K	On/Off	High	1490lm/16W	2,8	LG9AWE-840H-L890-YW	LG9ABE-840H-L890-YB	576,00
1182	4000K	On/Off	Low	1110lm/12W	3,5	LG9AWE-840E-L1182-YW	LG9ABE-840E-L1182-YB	629,00
1182	4000K	On/Off	High	1990lm/21W	3,5	LG9AWE-840H-L1182-YW	LG9ABE-840H-L1182-YB	629,00
1475	4000K	On/Off	Low	1390lm/14W	4,1	LG9AWE-840E-L1475-YW	LG9ABE-840E-L1475-YB	727,00
1475	4000K	On/Off	High	2480lm/25W	4,1	LG9AWE-840H-L1475-YW	LG9ABE-840H-L1475-YB	727,00
1765	4000K	On/Off	Low	1660lm/17W	4,8	LG9AWE-840E-L1765-YW	LG9ABE-840E-L1765-YB	884,00
1765	4000K	On/Off	High	2980lm/30W	4,8	LG9AWE-840H-L1765-YW	LG9ABE-840H-L1765-YB	884,00
2055	4000K	On/Off	Low	1940lm/22W	5,7	LG9AWE-840E-L2055-YW	LG9ABE-840E-L2055-YB	1084,00
2055	4000K	On/Off	High	3480lm/37W	5,7	LG9AWE-840H-L2055-YW	LG9ABE-840H-L2055-YB	1084,00
per meter	4000K	On/Off	Low	940lm/9,5W	3,1	LG9AWE-840E-L****-YW	LG9ABE-840E-L****-YB	534,00
per meter	4000K	On/Off	High	1690lm/16,9W	3,1	LG9AWE-840H-L****-YW	LG9ABE-840H-L****-YB	534,00
per meter	4000K	DALI	Low	940lm/9,5W	3,1	LG9AWL-840E-L****-YW	LG9ABL-840E-L****-YB	587,00
per meter	4000K	DALI	High	1690lm/16,9W	3,1	LG9AWL-840H-L****-YW	LG9ABL-840H-L****-YB	587,00

Opal Diffuser | Direct-Indirect

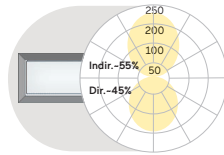

L mm	Colour Temperature	Control	Power	Lumen/Watt	Weight kg	Code Snow White/Snow White	Code Jet Black/Jet Black	CHF
890	4000K	On/Off	Medium	2720lm/26W	4,5	LR9OWE-840M-L890-YW	LR9OBE-840M-L890-YB	786,00
890	4000K	On/Off	High	3570lm/33W	4,5	LR9OWE-840H-L890-YW	LR9OBE-840H-L890-YB	786,00
1182	4000K	On/Off	Medium	3690lm/33W	5,5	LR9OWE-840M-L1182-YW	LR9OBE-840M-L1182-YB	849,00
1182	4000K	On/Off	High	4840lm/44W	5,5	LR9OWE-840H-L1182-YW	LR9OBE-840H-L1182-YB	849,00
1475	4000K	On/Off	Medium	4660lm/41W	6,6	LR9OWE-840M-L1475-YW	LR9OBE-840M-L1475-YB	979,00
1475	4000K	On/Off	High	6110lm/54W	6,6	LR9OWE-840H-L1475-YW	LR9OBE-840H-L1475-YB	979,00
1765	4000K	On/Off	Medium	5620lm/48W	7,6	LR9OWE-840M-L1765-YW	LR9OBE-840M-L1765-YB	1171,00
1765	4000K	On/Off	High	7380lm/64W	7,6	LR9OWE-840H-L1765-YW	LR9OBE-840H-L1765-YB	1171,00
2055	4000K	On/Off	Medium	6600lm/59W	9,1	LR9OWE-840M-L2055-YW	LR9OBE-840M-L2055-YB	1399,00
2055	4000K	On/Off	High	8660lm/78W	9,1	LR9OWE-840H-L2055-YW	LR9OBE-840H-L2055-YB	1399,00
per meter	4000K	On/Off	Medium	3190lm/27,2W	4,9	LR9OWE-840M-L****-YW	LR9OBE-840M-L****-YB	683,00
per meter	4000K	On/Off	High	4190lm/36,1W	4,9	LR9OWE-840H-L****-YW	LR9OBE-840H-L****-YB	683,00
per meter	4000K	DALI	Medium	3190lm/27,2W	4,9	LR9OWL-840M-L****-YW	LR9OBL-840M-L****-YB	753,00
per meter	4000K	DALI	High	4190lm/36,1W	4,9	LR9OWL-840H-L****-YW	LR9OBL-840H-L****-YB	753,00

Opal Diffuser | Direct

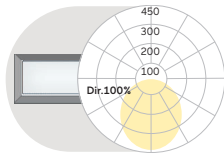

L mm	Colour Temperature	Control	Power	Lumen/Watt	Weight kg	Code Snow White/Snow White	Code Jet Black/Jet Black	CHF
890	4000K	On/Off	Medium	1170lm/12W	2,8	LG9OWE-840M-L890-YW	LG9OBE-840M-L890-YB	559,00
890	4000K	On/Off	High	1590lm/16W	2,8	LG9OWE-840H-L890-YW	LG9OBE-840H-L890-YB	559,00
1182	4000K	On/Off	Medium	1560lm/15W	3,5	LG9OWE-840M-L1182-YW	LG9OBE-840M-L1182-YB	604,00
1182	4000K	On/Off	High	2110lm/21W	3,5	LG9OWE-840H-L1182-YW	LG9OBE-840H-L1182-YB	604,00
1475	4000K	On/Off	Medium	1950lm/19W	4,1	LG9OWE-840M-L1475-YW	LG9OBE-840M-L1475-YB	692,00
1475	4000K	On/Off	High	2640lm/25W	4,1	LG9OWE-840H-L1475-YW	LG9OBE-840H-L1475-YB	692,00
1765	4000K	On/Off	Medium	2330lm/22W	4,8	LG9OWE-840M-L1765-YW	LG9OBE-840M-L1765-YB	839,00
1765	4000K	On/Off	High	3170lm/30W	4,8	LG9OWE-840H-L1765-YW	LG9OBE-840H-L1765-YB	839,00
2055	4000K	On/Off	Medium	2720lm/28W	5,7	LG9OWE-840M-L2055-YW	LG9OBE-840M-L2055-YB	1014,00
2055	4000K	On/Off	High	3700lm/37W	5,7	LG9OWE-840H-L2055-YW	LG9OBE-840H-L2055-YB	1014,00
per meter	4000K	On/Off	Medium	1320lm/12,4W	3,1	LG9OWE-840M-L****-YW	LG9OBE-840M-L****-YB	499,00
per meter	4000K	On/Off	High	1800lm/16,9W	3,1	LG9OWE-840H-L****-YW	LG9OBE-840H-L****-YB	499,00
per meter	4000K	DALI	Medium	1320lm/12,4W	3,1	LG9OWL-840M-L****-YW	LG9OBL-840M-L****-YB	552,00
per meter	4000K	DALI	High	1800lm/16,9W	3,1	LG9OWL-840H-L****-YW	LG9OBL-840H-L****-YB	552,00

**** Your length in mm

Meterpreise für Lichtsysteme nach Maß ab Mindestlänge 2200mm | Prices per metre for customised lighting systems with a minimum length of 2200mm
 Prix au mètre pour systèmes d'éclairage sur mesure à partir d'une longueur minimale de 2200mm

Surcharges

Surface / Reflector Finish + Lens Louvre*

Uni-Colours	CHF
W...W: Snow White / Snow White	✓
V...V: Ivory White / Ivory White	✓
A...A: Satin Silver / Satin Silver	✓
U...U: Urban Graphite / Urban Graphite	✓
B...B: Jet Black / Jet Black	✓
H...H: Anodic Champ. / Anodic Champ.	+10%
K...K: Satin Copper / Satin Copper	+15%

Surface / Reflector Finish + Lens Louvre*

Dual Colours	CHF
W...G: Snow White / Satin Gold	+15%
W...K: Snow White / Satin Copper	+15%
W...B: Snow White / Jet Black	+15%
H...B: Anodic Champagne / Jet Black	+15%
B...G: Jet Black / Satin Gold	+15%
B...W: Jet Black / Snow White	+15%

Colour Rendering	CHF
8: CRI>80	✓
9: CRI>90	+5%
F: Full Spectrum	+15%

Control Gear

	CHF L890-L1765	CHF L2055
E: On/Off	✓	✓
L: DALI	+86,00	+172,00
H: Touch-Dim	+86,00	+172,00
C: Casambi*	+261,00	+261,00
6: DALI DT6 for TW [L1182-L2055]	+172,00	+343,00
8: DALI DT8 for TW	+172,00	+343,00

*Only in combination with DALI. Please add to dimming price.

Colour Temperature

CHF	
22: 2200K	+5%
27: 2700K	+5%
30: 3000K	✓
35: 3500K	+5%
40: 4000K	✓
65: 6500K	+5%
TW: Tunable White 2700-6500K*	+30%

*Only in combination with DT6, DT8 or Casambi control. Please add additional control price.

Additional Options

CHF	
Emergency Module [L1182-L2055] [DALI, Autotest, incl. 3H Battery]	+366,00

✓ standard / no extra charge ⚠ on request ✗ not available

Matric RY | System 40mm Suspended

catalogue page 308

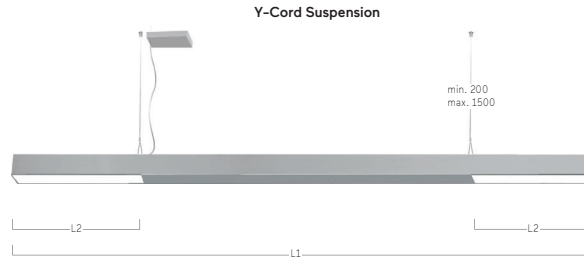
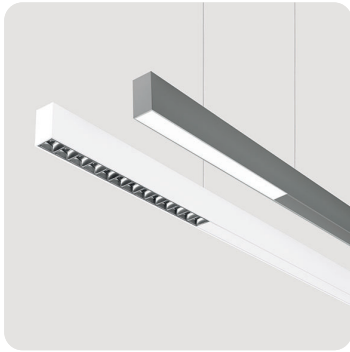

L1	L2 Lens Louvre	L2 Microprismatic, Opal Diffuser
1750	529	490
2400	661	590
2930	925	881



Lens Louvre | Direct-Indirect

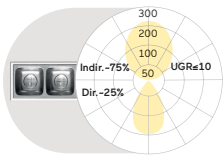

L mm	Colour Temperature	Control	Power	Lumen/Watt	Weight kg	Code Snow White/Jet Black	Code Jet Black/Jet Black	CHF
1750	4000K	On/Off	Medium	6880lm/53W	3,9	LRYLWE-840M-L1750-YB*	LRYLBE-840M-L1750-YB*	961,00
1750	4000K	On/Off	High	7480lm/58W	3,9	LRYLWE-840H-L1750-YB*	LRYLBE-840H-L1750-YB*	961,00
2400	4000K	On/Off	Medium	9140lm/68W	5,0	LRYLWE-840M-L2400-YB*	LRYLBE-840M-L2400-YB*	1206,00
2400	4000K	On/Off	High	9880lm/74W	5,0	LRYLWE-840H-L2400-YB*	LRYLBE-840H-L2400-YB*	1206,00
2930	4000K	On/Off	Medium	11800lm/85W	5,9	LRYLWE-840M-L2930-YB*	LRYLBE-840M-L2930-YB*	1364,00
2930	4000K	On/Off	High	12850lm/94W	5,9	LRYLWE-840H-L2930-YB*	LRYLBE-840H-L2930-YB*	1364,00

Microprismatic | Direct-Indirect

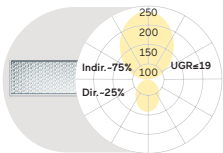

L mm	Colour Temperature	Control	Power	Lumen/Watt	Weight kg	Code Snow White	Code Jet Black	CHF
1750	4000K	On/Off	Medium	6960lm/55W	3,9	LRYAWE-840M-L1750-Y	LRYABE-840M-L1750-Y	914,00
1750	4000K	On/Off	High	7600lm/62W	3,9	LRYAWE-840H-L1750-Y	LRYABE-840H-L1750-Y	914,00
2400	4000K	On/Off	Medium	9160lm/70W	5,0	LRYAWE-840M-L2400-Y	LRYABE-840M-L2400-Y	1147,00
2400	4000K	On/Off	High	9920lm/78W	5,0	LRYAWE-840H-L2400-Y	LRYABE-840H-L2400-Y	1147,00
2930	4000K	On/Off	Medium	12030lm/91W	5,9	LRYAWE-840M-L2930-Y	LRYABE-840M-L2930-Y	1297,00
2930	4000K	On/Off	High	13170lm/104W	5,9	LRYAWE-840H-L2930-Y	LRYABE-840H-L2930-Y	1297,00

Opal Diffuser | Direct-Indirect

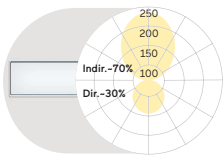

L mm	Colour Temperature	Control	Power	Lumen/Watt	Weight kg	Code Snow White	Code Jet Black	CHF
1750	4000K	On/Off	Medium	7080lm/55W	3,9	LRYOWE-840M-L1750-Y	LRYOBE-840M-L1750-Y	886,00
1750	4000K	On/Off	High	7760lm/62W	3,9	LRYOWE-840H-L1750-Y	LRYOBE-840H-L1750-Y	886,00
2400	4000K	On/Off	Medium	9300lm/70W	5,0	LRYOWE-840M-L2400-Y	LRYOBE-840M-L2400-Y	1110,00
2400	4000K	On/Off	High	10110lm/78W	5,0	LRYOWE-840H-L2400-Y	LRYOBE-840H-L2400-Y	1110,00
2930	4000K	On/Off	Medium	12240lm/91W	5,9	LRYOWE-840M-L2930-Y	LRYOBE-840M-L2930-Y	1255,00
2930	4000K	On/Off	High	13460lm/104W	5,9	LRYOWE-840H-L2930-Y	LRYOBE-840H-L2930-Y	1255,00

Surcharges

Surface Finish	CHF	Control Gear	CHF	Colour Rendering	CHF	Colour Temperature	CHF	Lens Louvre*	CHF
W: Snow White	✓	E: On/Off	✓	8: CRI>80	✓	22: 2200K	+5%	W: Snow White	✓
V: Ivory White	✓	L: DALI	+86,00	9: CRI>90	+5%	27: 2700K	+5%	A: Satin Silver	✓
A: Satin Silver	✓	H: Touch-Dim	+86,00	F: Full Spectrum	+15%	30: 3000K	✓	B: Jet Black	✓
S: Radiant Silver	✓	C: Casambi* [+100mm]	+261,00			35: 3500K	+5%	H: Anodic Champagne	✓
U: Urban Graphite	✓					40: 4000K	✓	K: Satin Copper	✓
B: Jet Black	✓					65: 6500K	+5%	G: Satin Gold	✓
H: Anodic Champagne	+10%	*Only in combination with DALI. Please add to dimming price.						Additional Options	CHF
K: Satin Copper	+15%							Multisensor [+200mm]	+261,00
R: Special RAL/NCS Colours	⚠								

✓ standard / no extra charge ⚠ on request ✗ not available

Matric GX/RX | System 40mm Suspended

catalogue page 310

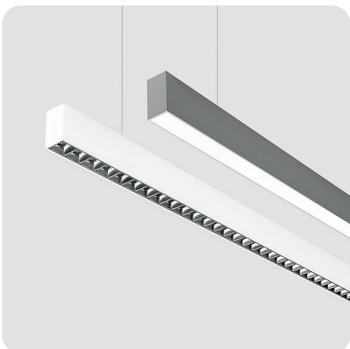

Lens Louvre | Direct-Indirect

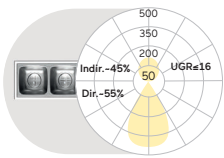

L mm	Colour Temperature	Control	Power	Lumen/Watt	Weight kg	Code Snow White/Jet Black	Code Silver Anodised/Jet Black	CHF
930	4000K	On/Off	Low	2760lm/24W	3,0	LRXLWE-840E-L930-YB*	LRXLEE-840E-L930-YB*	786,00
930	4000K	On/Off	High	5020lm/43W	3,0	LRXLWE-840H-L930-YB*	LRXLEE-840H-L930-YB*	786,00
1194	4000K	On/Off	Low	3480lm/29W	3,6	LRXLWE-840E-L1194-YB*	LRXLEE-840E-L1194-YB*	909,00
1194	4000K	On/Off	High	6320lm/53W	3,6	LRXLWE-840H-L1194-YB*	LRXLEE-840H-L1194-YB*	909,00
1458	4000K	On/Off	Low	4320lm/35W	4,2	LRXLWE-840E-L1458-YB*	LRXLEE-840E-L1458-YB*	1084,00
1458	4000K	On/Off	High	7860lm/65W	4,2	LRXLWE-840H-L1458-YB*	LRXLEE-840H-L1458-YB*	1084,00
1723	4000K	On/Off	Low	5180lm/41W	4,8	LRXLWE-840E-L1723-YB*	LRXLEE-840E-L1723-YB*	1287,00
1723	4000K	On/Off	High	9400lm/76W	4,8	LRXLWE-840H-L1723-YB*	LRXLEE-840H-L1723-YB*	1287,00
1987	4000K	On/Off	Low	5880lm/46W	5,9	LRXLWE-840E-L1987-YB*	LRXLEE-840E-L1987-YB*	1532,00
1987	4000K	On/Off	High	10700lm/86W	5,9	LRXLWE-840H-L1987-YB*	LRXLEE-840H-L1987-YB*	1532,00
per meter	4000K	On/Off	Low	3020lm/23,3W	3,1	LRXLWE-840E-L****-YB*	LRXLEE-840E-L****-YB*	770,00
per meter	4000K	On/Off	High	5470lm/43,8W	3,1	LRXLWE-840H-L****-YB*	LRXLEE-840H-L****-YB*	770,00
per meter	4000K	DALI	Low	3020lm/23,3W	3,1	LRXLWL-840E-L****-YB*	LRXLEL-840E-L****-YB*	840,00
per meter	4000K	DALI	High	5470lm/43,8W	3,1	LRXLWL-840H-L****-YB*	LRXLEL-840H-L****-YB*	840,00

Lens Louvre | Direct

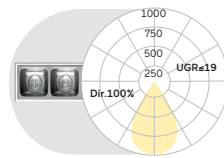

L mm	Colour Temperature	Control	Power	Lumen/Watt	Weight kg	Code Snow White/Jet Black	Code Silver Anodised/Jet Black	CHF
930	4000K	On/Off	Low	1520lm/13W	2,3	LGXLWE-840E-L930-YB*	LGXLEE-840E-L930-YB*	629,00
930	4000K	On/Off	High	2790lm/24W	2,3	LGXLWE-840H-L930-YB*	LGXLEE-840H-L930-YB*	629,00
1194	4000K	On/Off	Low	1960lm/16W	2,8	LGXLWE-840E-L1194-YB*	LGXLEE-840E-L1194-YB*	699,00
1194	4000K	On/Off	High	3590lm/30W	2,8	LGXLWE-840H-L1194-YB*	LGXLEE-840H-L1194-YB*	699,00
1458	4000K	On/Off	Low	2390lm/19W	3,3	LGXLWE-840E-L1458-YB*	LGXLEE-840E-L1458-YB*	821,00
1458	4000K	On/Off	High	4390lm/37W	3,3	LGXLWE-840H-L1458-YB*	LGXLEE-840H-L1458-YB*	821,00
1723	4000K	On/Off	Low	2830lm/23W	3,7	LGXLWE-840E-L1723-YB*	LGXLEE-840E-L1723-YB*	989,00
1723	4000K	On/Off	High	5190lm/43W	3,7	LGXLWE-840H-L1723-YB*	LGXLEE-840H-L1723-YB*	989,00
1987	4000K	On/Off	Low	3260lm/26W	4,2	LGXLWE-840E-L1987-YB*	LGXLEE-840E-L1987-YB*	1199,00
1987	4000K	On/Off	High	5990lm/49W	4,2	LGXLWE-840H-L1987-YB*	LGXLEE-840H-L1987-YB*	1199,00
per meter	4000K	On/Off	Low	1650lm/12,5W	2,4	LGXLWE-840E-L****-YB*	LGXLEE-840E-L****-YB*	595,00
per meter	4000K	On/Off	High	3020lm/24,1W	2,4	LGXLWE-840H-L****-YB*	LGXLEE-840H-L****-YB*	595,00
per meter	4000K	DALI	Low	1650lm/12,5W	2,4	LGXLWL-840E-L****-YB*	LGXLEL-840E-L****-YB*	648,00
per meter	4000K	DALI	High	3020lm/24,1W	2,4	LGXLWL-840H-L****-YB*	LGXLEL-840H-L****-YB*	648,00

Microprismatic | Direct-Indirect

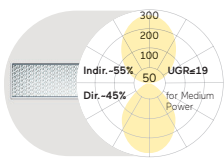

L mm	Colour Temperature	Control	Power	Lumen/Watt	Weight kg	Code Snow White	Code Silver Anodised	CHF
890	4000K	On/Off	Medium	2760lm/26W	2,9	LRXAWWE-840M-L890-Y	LRXAAEE-840M-L890-Y	734,00
890	4000K	On/Off	High	3630lm/33W	2,9	LRXAWWE-840H-L890-Y	LRXAAEE-840H-L890-Y	734,00
1182	4000K	On/Off	Medium	3750lm/33W	3,5	LRXAWWE-840M-L1182-Y	LRXAAEE-840M-L1182-Y	779,00
1182	4000K	On/Off	High	4930lm/44W	3,5	LRXAWWE-840H-L1182-Y	LRXAAEE-840H-L1182-Y	779,00
1475	4000K	On/Off	Medium	4730lm/41W	4,2	LRXAWWE-840M-L1475-Y	LRXAAEE-840M-L1475-Y	891,00
1475	4000K	On/Off	High	6220lm/54W	4,2	LRXAWWE-840H-L1475-Y	LRXAAEE-840H-L1475-Y	891,00
1765	4000K	On/Off	Medium	5720lm/48W	4,8	LRXAWWE-840M-L1765-Y	LRXAAEE-840M-L1765-Y	1066,00
1765	4000K	On/Off	High	7510lm/64W	4,8	LRXAWWE-840H-L1765-Y	LRXAAEE-840H-L1765-Y	1066,00
2055	4000K	On/Off	Medium	6710lm/59W	5,4	LRXAWWE-840M-L2055-Y	LRXAAEE-840M-L2055-Y	1294,00
2055	4000K	On/Off	High	8810lm/78W	5,4	LRXAWWE-840H-L2055-Y	LRXAAEE-840H-L2055-Y	1294,00
per meter	4000K	On/Off	Medium	3240lm/27,2W	3,1	LRXAWWE-840M-L****-Y	LRXAAEE-840M-L****-Y	630,00
per meter	4000K	On/Off	High	4260lm/36,1W	3,1	LRXAWWE-840H-L****-Y	LRXAAEE-840H-L****-Y	630,00
per meter	4000K	DALI	Medium	3240lm/27,2W	3,1	LRXAWLW-840M-L****-Y	LRXAAEL-840M-L****-Y	700,00
per meter	4000K	DALI	High	4260lm/36,1W	3,1	LRXAWLW-840H-L****-Y	LRXAAEL-840H-L****-Y	700,00

Microprismatic | Direct

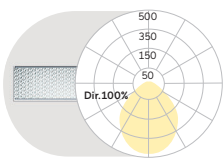

L mm	Colour Temperature	Control	Power	Lumen/Watt	Weight kg	Code Snow White	Code Silver Anodised	CHF
890	4000K	On/Off	Low	920lm/10W	2,2	LGXAWWE-840E-L890-Y	LGXAAEE-840E-L890-Y	524,00
890	4000K	On/Off	High	1650lm/16W	2,2	LGXAWWE-840H-L890-Y	LGXAAEE-840H-L890-Y	524,00
1182	4000K	On/Off	Low	1230lm/12W	2,7	LGXAWWE-840E-L1182-Y	LGXAAEE-840E-L1182-Y	552,00
1182	4000K	On/Off	High	2200lm/21W	2,7	LGXAWWE-840H-L1182-Y	LGXAAEE-840H-L1182-Y	552,00
1475	4000K	On/Off	Low	1530lm/14W	3,2	LGXAWWE-840E-L1475-Y	LGXAAEE-840E-L1475-Y	622,00
1475	4000K	On/Off	High	2750lm/25W	3,2	LGXAWWE-840H-L1475-Y	LGXAAEE-840H-L1475-Y	622,00
1765	4000K	On/Off	Low	1840lm/17W	3,7	LGXAWWE-840E-L1765-Y	LGXAAEE-840E-L1765-Y	751,00
1765	4000K	On/Off	High	3300lm/30W	3,7	LGXAWWE-840H-L1765-Y	LGXAAEE-840H-L1765-Y	751,00
2055	4000K	On/Off	Low	2150lm/22W	4,2	LGXAWWE-840E-L2055-Y	LGXAAEE-840E-L2055-Y	902,00
2055	4000K	On/Off	High	3850lm/37W	4,2	LGXAWWE-840H-L2055-Y	LGXAAEE-840H-L2055-Y	902,00
per meter	4000K	On/Off	Low	1040lm/9,5W	2,4	LGXAWWE-840E-L****-Y	LGXAAEE-840E-L****-Y	447,00
per meter	4000K	On/Off	High	1870lm/16,9W	2,4	LGXAWWE-840H-L****-Y	LGXAAEE-840H-L****-Y	447,00
per meter	4000K	DALI	Low	1040lm/9,5W	2,4	LGXAWLW-840E-L****-Y	LGXAAEL-840E-L****-Y	499,00
per meter	4000K	DALI	High	1870lm/16,9W	2,4	LGXAWLW-840H-L****-Y	LGXAAEL-840H-L****-Y	499,00

Opal Diffuser | Direct-Indirect

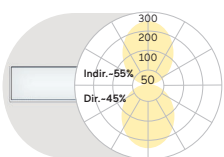

L mm	Colour Temperature	Control	Power	Lumen/Watt	Weight kg	Code Snow White	Code Silver Anodised	CHF
890	4000K	On/Off	Medium	2850lm/26W	2,9	LRXOWWE-840M-L890-Y	LRXOEAE-840M-L890-Y	716,00
890	4000K	On/Off	High	3740lm/33W	2,9	LRXOWWE-840H-L890-Y	LRXOEAE-840H-L890-Y	716,00
1182	4000K	On/Off	Medium	3860lm/33W	3,5	LRXOWWE-840M-L1182-Y	LRXOEAE-840M-L1182-Y	751,00
1182	4000K	On/Off	High	5080lm/44W	3,5	LRXOWWE-840H-L1182-Y	LRXOEAE-840H-L1182-Y	751,00
1475	4000K	On/Off	Medium	4870lm/41W	4,2	LRXOWWE-840M-L1475-Y	LRXOEAE-840M-L1475-Y	856,00
1475	4000K	On/Off	High	6410lm/54W	4,2	LRXOWWE-840H-L1475-Y	LRXOEAE-840H-L1475-Y	856,00
1765	4000K	On/Off	Medium	5890lm/48W	4,8	LRXOWWE-840M-L1765-Y	LRXOEAE-840M-L1765-Y	1014,00
1765	4000K	On/Off	High	7740lm/64W	4,8	LRXOWWE-840H-L1765-Y	LRXOEAE-840H-L1765-Y	1014,00
2055	4000K	On/Off	Medium	6910lm/59W	5,4	LRXOWWE-840M-L2055-Y	LRXOEAE-840M-L2055-Y	1224,00
2055	4000K	On/Off	High	9070lm/78W	5,4	LRXOWWE-840H-L2055-Y	LRXOEAE-840H-L2055-Y	1224,00
per meter	4000K	On/Off	Medium	3340lm/27,2W	3,1	LRXOWWE-840M-L****-Y	LRXOEAE-840M-L****-Y	595,00
per meter	4000K	On/Off	High	4390lm/36,1W	3,1	LRXOWWE-840H-L****-Y	LRXOEAE-840H-L****-Y	595,00
per meter	4000K	DALI	Medium	3340lm/27,2W	3,1	LRXOWLW-840M-L****-Y	LRXOELE-840M-L****-Y	665,00
per meter	4000K	DALI	High	4390lm/36,1W	3,1	LRXOWLW-840H-L****-Y	LRXOELE-840H-L****-Y	665,00

... Matric GX/RX | System 40mm Suspended

Opal Diffuser | Direct

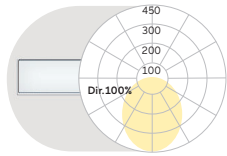

L mm	Colour Temperature	Control	Power	Lumen/Watt	Weight kg	Code Snow White	Code Silver Anodised	CHF
890	4000K	On/Off	Medium	1300lm/12W	2,2	LGXOWE-840M-L890-Y	LGXOEE-840M-L890-Y	506,00
890	4000K	On/Off	High	1760lm/16W	2,2	LGXOWE-840H-L890-Y	LGXOEE-840H-L890-Y	506,00
1182	4000K	On/Off	Medium	1730lm/15W	2,7	LGXOWE-840M-L1182-Y	LGXOEE-840M-L1182-Y	524,00
1182	4000K	On/Off	High	2350lm/21W	2,7	LGXOWE-840H-L1182-Y	LGXOEE-840H-L1182-Y	524,00
1475	4000K	On/Off	Medium	2160lm/19W	3,2	LGXOWE-840M-L1475-Y	LGXOEE-840M-L1475-Y	587,00
1475	4000K	On/Off	High	2940lm/25W	3,2	LGXOWE-840H-L1475-Y	LGXOEE-840H-L1475-Y	587,00
1765	4000K	On/Off	Medium	2600lm/22W	3,7	LGXOWE-840M-L1765-Y	LGXOEE-840M-L1765-Y	699,00
1765	4000K	On/Off	High	3530lm/30W	3,7	LGXOWE-840H-L1765-Y	LGXOEE-840H-L1765-Y	699,00
2055	4000K	On/Off	Medium	3030lm/28W	4,2	LGXOWE-840M-L2055-Y	LGXOEE-840M-L2055-Y	839,00
2055	4000K	On/Off	High	4110lm/37W	4,2	LGXOWE-840H-L2055-Y	LGXOEE-840H-L2055-Y	839,00
per meter	4000K	On/Off	Medium	1470lm/12,4W	2,4	LGXOWE-840M-L****-Y	LGXOEE-840M-L****-Y	420,00
per meter	4000K	On/Off	High	2000lm/16,9W	2,4	LGXOWE-840H-L****-Y	LGXOEE-840H-L****-Y	420,00
per meter	4000K	DALI	Medium	1470lm/12,4W	2,4	LGXOWL-840M-L****-Y	LGXOEL-840M-L****-Y	473,00
per meter	4000K	DALI	High	2000lm/16,9W	2,4	LGXOWL-840H-L****-Y	LGXOEL-840H-L****-Y	473,00

Wallwasher | Direct-Indirect

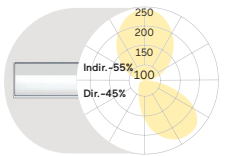

L mm	Colour Temperature	Control	Power	Lumen/Watt	Weight kg	Code Snow White	Code Silver Anodised	CHF
890	4000K	On/Off	Medium	2810lm/26W	2,9	LRXGWE-840M-L890-Y	LRXGEE-840M-L890-Y	758,00
890	4000K	On/Off	High	3590lm/34W	2,9	LRXGWE-840H-L890-Y	LRXGEE-840H-L890-Y	758,00
1182	4000K	On/Off	Medium	3810lm/37W	3,5	LRXGWE-840M-L1182-Y	LRXGEE-840M-L1182-Y	798,00
1182	4000K	On/Off	High	4880lm/48W	3,5	LRXGWE-840H-L1182-Y	LRXGEE-840H-L1182-Y	798,00
1475	4000K	On/Off	Medium	4810lm/45W	4,2	LRXGWE-840M-L1475-Y	LRXGEE-840M-L1475-Y	907,00
1475	4000K	On/Off	High	6150lm/59W	4,2	LRXGWE-840H-L1475-Y	LRXGEE-840H-L1475-Y	907,00
1765	4000K	On/Off	Medium	5810lm/54W	4,8	LRXGWE-840M-L1765-Y	LRXGEE-840M-L1765-Y	1101,00
1765	4000K	On/Off	High	7430lm/70W	4,8	LRXGWE-840H-L1765-Y	LRXGEE-840H-L1765-Y	1101,00
2055	4000K	On/Off	Medium	6820lm/65W	6,0	LRXGWE-840M-L2055-Y	LRXGEE-840M-L2055-Y	1364,00
2055	4000K	On/Off	High	8720lm/85W	6,0	LRXGWE-840H-L2055-Y	LRXGEE-840H-L2055-Y	1364,00
per meter	4000K	On/Off	Medium	3300lm/30,4W	3,1	LRXGWE-840M-L****-Y	LRXGEE-840M-L****-Y	665,00
per meter	4000K	On/Off	High	4210lm/39,4W	3,1	LRXGWE-840H-L****-Y	LRXGEE-840H-L****-Y	665,00
per meter	4000K	DALI	Medium	3300lm/30,4W	3,1	LRXGWL-840M-L****-Y	LRXGEL-840M-L****-Y	735,00
per meter	4000K	DALI	High	4210lm/39,4W	3,1	LRXGWL-840H-L****-Y	LRXGEL-840H-L****-Y	735,00

Wallwasher | Direct

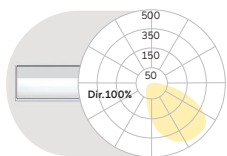

L mm	Colour Temperature	Control	Power	Lumen/Watt	Weight kg	Code Snow White	Code Silver Anodised	CHF
890	4000K	On/Off	Medium	1260lm/15W	2,2	LGXGWE-840M-L890-Y	LGXGEE-840M-L890-Y	560,00
890	4000K	On/Off	High	1610lm/19W	2,2	LGXGWE-840H-L890-Y	LGXGEE-840H-L890-Y	560,00
1182	4000K	On/Off	Medium	1680lm/19W	2,7	LGXGWE-840M-L1182-Y	LGXGEE-840M-L1182-Y	608,00
1182	4000K	On/Off	High	2150lm/25W	2,7	LGXGWE-840H-L1182-Y	LGXGEE-840H-L1182-Y	608,00
1475	4000K	On/Off	Medium	2100lm/23W	3,3	LGXGWE-840M-L1475-Y	LGXGEE-840M-L1475-Y	671,00
1475	4000K	On/Off	High	2680lm/30W	3,3	LGXGWE-840H-L1475-Y	LGXGEE-840H-L1475-Y	671,00
1765	4000K	On/Off	Medium	2520lm/28W	3,8	LGXGWE-840M-L1765-Y	LGXGEE-840M-L1765-Y	774,00
1765	4000K	On/Off	High	3220lm/36W	3,8	LGXGWE-840H-L1765-Y	LGXGEE-840H-L1765-Y	774,00
2055	4000K	On/Off	Medium	2940lm/34W	4,5	LGXGWE-840M-L2055-Y	LGXGEE-840M-L2055-Y	963,00
2055	4000K	On/Off	High	3760lm/44W	4,5	LGXGWE-840H-L2055-Y	LGXGEE-840H-L2055-Y	963,00
per meter	4000K	On/Off	Medium	1430lm/15,6W	2,4	LGXGWE-840M-L****-Y	LGXGEE-840M-L****-Y	464,00
per meter	4000K	On/Off	High	1830lm/20,3W	2,4	LGXGWE-840H-L****-Y	LGXGEE-840H-L****-Y	464,00
per meter	4000K	DALI	Medium	1430lm/15,6W	2,4	LGXGWL-840M-L****-Y	LGXGEL-840M-L****-Y	517,00
per meter	4000K	DALI	High	1830lm/20,3W	2,4	LGXGWL-840H-L****-Y	LGXGEL-840H-L****-Y	517,00

**** Your length in mm

Meterpreise für Lichtsysteme nach Maß ab Mindestlänge 2200mm | Prices per metre for customised lighting systems with a minimum length of 2200mm
 Prix au mètre pour systèmes d'éclairage sur mesure à partir d'une longueur minimale de 2200mm



90° Corner
Opal/Microprismatic



Midpin Spotlight XM
770lm/10W/Ø40mm

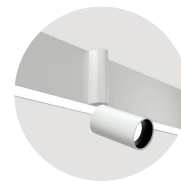

Midpin Spotlight XP
770lm/10W/Ø40mm



Multisensor

Surcharges

Surface Finish	CHF	Control Gear	CHF	CHF	Colour Temperature	CHF	Lens Louvre*	CHF	Colour Rendering	CHF
W: Snow White	✓	E: On/Off	✓	✓	22: 2200K	+5%	W: Snow White	✓	8: CRI>80	✓
V: Ivory White	✓	L: DALI	+86,00	+172,00	27: 2700K	+5%	A: Satin Silver	✓	9: CRI>90	+5%
A: Satin Silver	✓	H: Touch-Dim	+86,00	+172,00	30: 3000K	✓	B: Jet Black	✓	F: Full Spectrum	+15%
E: Silver Anodised	✓	C: Casambi*	+261,00	+261,00	35: 3500K	+5%	H: Anodic Champagne	✓		
U: Urban Graphite	✓	6: DALI DT6 for TW [L1475-L2055]	+172,00	+343,00	40: 4000K	✓	K: Satin Copper	✓	Additional Options	CHF
B: Jet Black	✓	8: DALI DT8 for TW	+172,00	+343,00	65: 6500K	+5%	G: Satin Gold	✓	90° Corner	ⓘ
H: Anodic Champagne	+10%				TW: Tunable White 2700-6500K*	+30%			Midpin Spotlight XM	+363,00
K: Satin Copper	+15%							Midpin Spotlight XP	+433,00	
R: Special RAL/NCS Colours	ⓘ							Multisensor [L1475-L2055]	+261,00	
								Emergency Module [DALI, Autotest, incl. 3H Battery] [L1475-L2055]	+366,00	

✓ standard / no extra charge ⓘ on request ✗ not available

Matric G3/R3 | System 55 mm Suspended

catalogue page 312

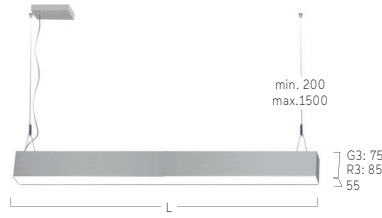
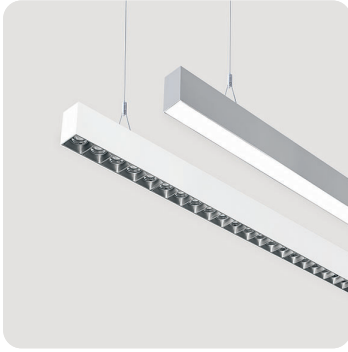

Lens Louvre | Direct-Indirect

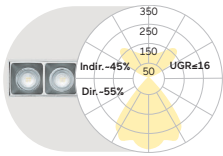

L mm	Colour Temperature	Control	Power	Lumen/Watt	Weight kg	Code Snow White/Jet Black	Code Silver Anodised/Jet Black	CHF
1002	4000K	On/Off	Medium	4510lm/34W	4,1	LR3LWE-840M-L1002-YB*	LR3LEE-840M-L1002-YB*	839,00
1002	4000K	On/Off	High	6340lm/48W	4,1	LR3LWE-840H-L1002-YB*	LR3LEE-840H-L1002-YB*	839,00
1252	4000K	On/Off	Medium	5800lm/42W	4,8	LR3LWE-840M-L1252-YB*	LR3LEE-840M-L1252-YB*	961,00
1252	4000K	On/Off	High	8170lm/61W	4,8	LR3LWE-840H-L1252-YB*	LR3LEE-840H-L1252-YB*	961,00
1502	4000K	On/Off	Medium	6870lm/49W	5,6	LR3LWE-840M-L1502-YB*	LR3LEE-840M-L1502-YB*	1129,00
1502	4000K	On/Off	High	9660lm/71W	5,6	LR3LWE-840H-L1502-YB*	LR3LEE-840H-L1502-YB*	1129,00
1752	4000K	On/Off	Medium	8160lm/57W	6,3	LR3LWE-840M-L1752-YB*	LR3LEE-840M-L1752-YB*	1322,00
1752	4000K	On/Off	High	11470lm/83W	6,3	LR3LWE-840H-L1752-YB*	LR3LEE-840H-L1752-YB*	1322,00
2002	4000K	On/Off	Medium	9240lm/63W	7,6	LR3LWE-840M-L2002-YB*	LR3LEE-840M-L2002-YB*	1567,00
2002	4000K	On/Off	High	12990lm/96W	7,6	LR3LWE-840H-L2002-YB*	LR3LEE-840H-L2002-YB*	1567,00
per meter	4000K	On/Off	Medium	4660lm/32,2W	4,1	LR3LWE-840M-L****-YB*	LR3LEE-840M-L****-YB*	779,00
per meter	4000K	On/Off	High	6560lm/47,3W	4,1	LR3LWE-840H-L****-YB*	LR3LEE-840H-L****-YB*	779,00
per meter	4000K	DALI	Medium	4660lm/32,2W	4,1	LR3LWL-840M-L****-YB*	LR3LEL-840M-L****-YB*	849,00
per meter	4000K	DALI	High	6560lm/47,3W	4,1	LR3LWL-840H-L****-YB*	LR3LEL-840H-L****-YB*	849,00

Lens Louvre | Direct

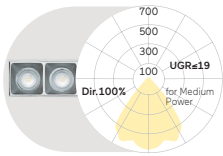

L mm	Colour Temperature	Control	Power	Lumen/Watt	Weight kg	Code Snow White/Jet Black	Code Silver Anodised/Jet Black	CHF
1002	4000K	On/Off	Medium	2500lm/19W	3,2	LG3LWE-840M-L1002-YB*	LG3LEE-840M-L1002-YB*	681,00
1002	4000K	On/Off	High	3590lm/28W	3,2	LG3LWE-840H-L1002-YB*	LG3LEE-840H-L1002-YB*	681,00
1252	4000K	On/Off	Medium	3120lm/23W	3,8	LG3LWE-840M-L1252-YB*	LG3LEE-840M-L1252-YB*	769,00
1252	4000K	On/Off	High	4500lm/34W	3,8	LG3LWE-840H-L1252-YB*	LG3LEE-840H-L1252-YB*	769,00
1502	4000K	On/Off	Medium	3750lm/27W	4,4	LG3LWE-840M-L1502-YB*	LG3LEE-840M-L1502-YB*	902,00
1502	4000K	On/Off	High	5380lm/40W	4,4	LG3LWE-840H-L1502-YB*	LG3LEE-840H-L1502-YB*	902,00
1752	4000K	On/Off	Medium	4370lm/31W	5,0	LG3LWE-840M-L1752-YB*	LG3LEE-840M-L1752-YB*	1077,00
1752	4000K	On/Off	High	6280lm/46W	5,0	LG3LWE-840H-L1752-YB*	LG3LEE-840H-L1752-YB*	1077,00
2002	4000K	On/Off	Medium	5000lm/35W	5,8	LG3LWE-840M-L2002-YB*	LG3LEE-840M-L2002-YB*	1295,00
2002	4000K	On/Off	High	7180lm/53W	5,8	LG3LWE-840H-L2002-YB*	LG3LEE-840H-L2002-YB*	1295,00
per meter	4000K	On/Off	Medium	2500lm/17,3W	3,2	LG3LWE-840M-L****-YB*	LG3LEE-840M-L****-YB*	648,00
per meter	4000K	On/Off	High	3600lm/26,4W	3,2	LG3LWE-840H-L****-YB*	LG3LEE-840H-L****-YB*	648,00
per meter	4000K	DALI	Medium	2500lm/17,3W	3,2	LG3LWL-840M-L****-YB*	LG3LEL-840M-L****-YB*	700,00
per meter	4000K	DALI	High	3600lm/26,4W	3,2	LG3LWL-840H-L****-YB*	LG3LEL-840H-L****-YB*	700,00

Microprismatic | Direct-Indirect

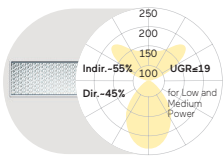

L mm	Colour Temperature	Control	Power	Lumen/Watt	Weight kg	Code Snow White	Code Silver Anodised	CHF
890	4000K	On/Off	Low	2500lm/22W	3,5	LR3AWE-840E-L890-Y	LR3AEE-840E-L890-Y	769,00
890	4000K	On/Off	Medium	3440lm/30W	3,5	LR3AWE-840M-L890-Y	LR3AEE-840M-L890-Y	769,00
890	4000K	On/Off	High	4790lm/42W	3,5	LR3AWE-840H-L890-Y	LR3AEE-840H-L890-Y	769,00
1182	4000K	On/Off	Low	3390lm/28W	4,3	LR3AWE-840E-L1182-Y	LR3AEE-840E-L1182-Y	821,00
1182	4000K	On/Off	Medium	4660lm/39W	4,3	LR3AWE-840M-L1182-Y	LR3AEE-840M-L1182-Y	821,00
1182	4000K	On/Off	High	6490lm/55W	4,3	LR3AWE-840H-L1182-Y	LR3AEE-840H-L1182-Y	821,00
1475	4000K	On/Off	Low	4270lm/35W	5,2	LR3AWE-840E-L1475-Y	LR3AEE-840E-L1475-Y	944,00
1475	4000K	On/Off	Medium	5890lm/48W	5,2	LR3AWE-840M-L1475-Y	LR3AEE-840M-L1475-Y	944,00
1475	4000K	On/Off	High	8200lm/68W	5,2	LR3AWE-840H-L1475-Y	LR3AEE-840H-L1475-Y	944,00
1765	4000K	On/Off	Low	5150lm/41W	6,0	LR3AWE-840E-L1765-Y	LR3AEE-840E-L1765-Y	1136,00
1765	4000K	On/Off	Medium	7110lm/56W	6,0	LR3AWE-840M-L1765-Y	LR3AEE-840M-L1765-Y	1136,00
1765	4000K	On/Off	High	9890lm/81W	6,0	LR3AWE-840H-L1765-Y	LR3AEE-840H-L1765-Y	1136,00
2055	4000K	On/Off	Low	6040lm/50W	7,3	LR3AWE-840E-L2055-Y	LR3AEE-840E-L2055-Y	1357,00
2055	4000K	On/Off	Medium	8330lm/69W	7,3	LR3AWE-840M-L2055-Y	LR3AEE-840M-L2055-Y	1357,00
2055	4000K	On/Off	High	11600lm/98W	7,3	LR3AWE-840H-L2055-Y	LR3AEE-840H-L2055-Y	1357,00
per meter	4000K	On/Off	Low	2920lm/23,1W	3,8	LR3AWE-840E-L****-Y	LR3AEE-840E-L****-Y	657,00
per meter	4000K	On/Off	Medium	4030lm/32,0W	3,8	LR3AWE-840M-L****-Y	LR3AEE-840M-L****-Y	657,00
per meter	4000K	On/Off	High	5610lm/45,9W	3,8	LR3AWE-840H-L****-Y	LR3AEE-840H-L****-Y	657,00
per meter	4000K	DALI	Low	2920lm/23,1W	3,8	LR3AWL-840E-L****-Y	LR3AEL-840E-L****-Y	727,00
per meter	4000K	DALI	Medium	4030lm/32,0W	3,8	LR3AWL-840M-L****-Y	LR3AEL-840M-L****-Y	727,00
per meter	4000K	DALI	High	5610lm/45,9W	3,8	LR3AWL-840H-L****-Y	LR3AEL-840H-L****-Y	727,00

**** Your length in mm

Meterpreise für Lichtsysteme nach Maß ab Mindestlänge 2200mm | Prices per metre for customised lighting systems with a minimum length of 2200mm
 Prix au mètre pour systèmes d'éclairage sur mesure à partir d'une longueur minimale de 2200mm

... Matric G3/R3 | System 55mm Suspended

Microprismatic | Direct

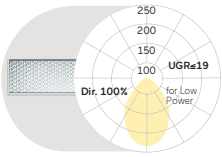

L mm	Colour Temperature	Control	Power	Lumen/Watt	Weight kg	Code Snow White	Code Silver Anodised	CHF
890	4000K	On/Off	Low	1230lm/12W	2,7	LG3AWE-840E-L890-Y	LG3AEE-840E-L890-Y	541,00
890	4000K	On/Off	Medium	1660lm/16W	2,7	LG3AWE-840M-L890-Y	LG3AEE-840M-L890-Y	541,00
890	4000K	On/Off	High	2350lm/24W	2,7	LG3AWE-840H-L890-Y	LG3AEE-840H-L890-Y	541,00
1182	4000K	On/Off	Low	1640lm/16W	3,0	LG3AWE-840E-L1182-Y	LG3AEE-840E-L1182-Y	576,00
1182	4000K	On/Off	Medium	2210lm/21W	3,0	LG3AWE-840M-L1182-Y	LG3AEE-840M-L1182-Y	576,00
1182	4000K	On/Off	High	3130lm/31W	3,0	LG3AWE-840H-L1182-Y	LG3AEE-840H-L1182-Y	576,00
1475	4000K	On/Off	Low	2050lm/19W	3,5	LG3AWE-840E-L1475-Y	LG3AEE-840E-L1475-Y	657,00
1475	4000K	On/Off	Medium	2770lm/26W	3,5	LG3AWE-840M-L1475-Y	LG3AEE-840M-L1475-Y	657,00
1475	4000K	On/Off	High	3920lm/37W	3,5	LG3AWE-840H-L1475-Y	LG3AEE-840H-L1475-Y	657,00
1765	4000K	On/Off	Low	2450lm/22W	4,0	LG3AWE-840E-L1765-Y	LG3AEE-840E-L1765-Y	797,00
1765	4000K	On/Off	Medium	3320lm/30W	4,0	LG3AWE-840M-L1765-Y	LG3AEE-840M-L1765-Y	797,00
1765	4000K	On/Off	High	4700lm/44W	4,0	LG3AWE-840H-L1765-Y	LG3AEE-840H-L1765-Y	797,00
2055	4000K	On/Off	Low	2860lm/28W	5,5	LG3AWE-840E-L2055-Y	LG3AEE-840E-L2055-Y	979,00
2055	4000K	On/Off	Medium	3870lm/38W	5,5	LG3AWE-840M-L2055-Y	LG3AEE-840M-L2055-Y	979,00
2055	4000K	On/Off	High	5490lm/54W	5,5	LG3AWE-840H-L2055-Y	LG3AEE-840H-L2055-Y	979,00
per meter	4000K	On/Off	Low	1390lm/12,5W	2,8	LG3AWE-840E-L****-Y	LG3AEE-840E-L****-Y	482,00
per meter	4000K	On/Off	Medium	1880lm/17,2W	2,8	LG3AWE-840M-L****-Y	LG3AEE-840M-L****-Y	482,00
per meter	4000K	On/Off	High	2670lm/25,2W	2,8	LG3AWE-840H-L****-Y	LG3AEE-840H-L****-Y	482,00
per meter	4000K	DALI	Low	1390lm/12,5W	2,8	LG3AWL-840E-L****-Y	LG3AEL-840E-L****-Y	534,00
per meter	4000K	DALI	Medium	1880lm/17,2W	2,8	LG3AWL-840M-L****-Y	LG3AEL-840M-L****-Y	534,00
per meter	4000K	DALI	High	2670lm/25,2W	2,8	LG3AWL-840H-L****-Y	LG3AEL-840H-L****-Y	534,00

Opal Diffuser | Direct-Indirect

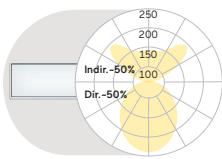

L mm	Colour Temperature	Control	Power	Lumen/Watt	Weight kg	Code Snow White	Code Silver Anodised	CHF
890	4000K	On/Off	Low	2620lm/22W	3,5	LR3OWE-840E-L890-Y	LR3OEE-840E-L890-Y	751,00
890	4000K	On/Off	Medium	3600lm/30W	3,5	LR3OWE-840M-L890-Y	LR3OEE-840M-L890-Y	751,00
890	4000K	On/Off	High	5020lm/42W	3,5	LR3OWE-840H-L890-Y	LR3OEE-840H-L890-Y	751,00
1182	4000K	On/Off	Low	3540lm/28W	4,3	LR3OWE-840E-L1182-Y	LR3OEE-840E-L1182-Y	797,00
1182	4000K	On/Off	Medium	4880lm/39W	4,3	LR3OWE-840M-L1182-Y	LR3OEE-840M-L1182-Y	797,00
1182	4000K	On/Off	High	6800lm/55W	4,3	LR3OWE-840H-L1182-Y	LR3OEE-840H-L1182-Y	797,00
1475	4000K	On/Off	Low	4460lm/35W	5,2	LR3OWE-840E-L1475-Y	LR3OEE-840E-L1475-Y	909,00
1475	4000K	On/Off	Medium	6150lm/48W	5,2	LR3OWE-840M-L1475-Y	LR3OEE-840M-L1475-Y	909,00
1475	4000K	On/Off	High	8580lm/68W	5,2	LR3OWE-840H-L1475-Y	LR3OEE-840H-L1475-Y	909,00
1765	4000K	On/Off	Low	5390lm/41W	6,0	LR3OWE-840E-L1765-Y	LR3OEE-840E-L1765-Y	1084,00
1765	4000K	On/Off	Medium	7430lm/56W	6,0	LR3OWE-840M-L1765-Y	LR3OEE-840M-L1765-Y	1084,00
1765	4000K	On/Off	High	10350lm/81W	6,0	LR3OWE-840H-L1765-Y	LR3OEE-840H-L1765-Y	1084,00
2055	4000K	On/Off	Low	6320lm/50W	7,3	LR3OWE-840E-L2055-Y	LR3OEE-840E-L2055-Y	1294,00
2055	4000K	On/Off	Medium	8710lm/69W	7,3	LR3OWE-840M-L2055-Y	LR3OEE-840M-L2055-Y	1294,00
2055	4000K	On/Off	High	12130lm/98W	7,3	LR3OWE-840H-L2055-Y	LR3OEE-840H-L2055-Y	1294,00
per meter	4000K	On/Off	Low	3060lm/23,1W	3,8	LR3OWE-840E-L****-Y	LR3OEE-840E-L****-Y	630,00
per meter	4000K	On/Off	Medium	4210lm/32,0W	3,8	LR3OWE-840M-L****-Y	LR3OEE-840M-L****-Y	630,00
per meter	4000K	On/Off	High	5870lm/45,9W	3,8	LR3OWE-840H-L****-Y	LR3OEE-840H-L****-Y	630,00
per meter	4000K	DALI	Low	3060lm/23,1W	3,8	LR3OWL-840E-L****-Y	LR3OEL-840E-L****-Y	700,00
per meter	4000K	DALI	Medium	4210lm/32,0W	3,8	LR3OWL-840M-L****-Y	LR3OEL-840M-L****-Y	700,00
per meter	4000K	DALI	High	5870lm/45,9W	3,8	LR3OWL-840H-L****-Y	LR3OEL-840H-L****-Y	700,00

Opal Diffuser | Direct

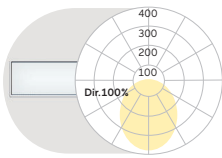

L mm	Colour Temperature	Control	Power	Lumen/Watt	Weight kg	Code Snow White	Code Silver Anodised	CHF
890	4000K	On/Off	Low	1350lm/12W	2,7	LG3OWE-840E-L890-Y	LG3OEE-840E-L890-Y	524,00
890	4000K	On/Off	Medium	1820lm/16W	2,7	LG3OWE-840M-L890-Y	LG3OEE-840M-L890-Y	524,00
890	4000K	On/Off	High	2580lm/24W	2,7	LG3OWE-840H-L890-Y	LG3OEE-840H-L890-Y	524,00
1182	4000K	On/Off	Low	1790lm/16W	3,0	LG3OWE-840E-L1182-Y	LG3OEE-840E-L1182-Y	552,00
1182	4000K	On/Off	Medium	2430lm/21W	3,0	LG3OWE-840M-L1182-Y	LG3OEE-840M-L1182-Y	552,00
1182	4000K	On/Off	High	3440lm/31W	3,0	LG3OWE-840H-L1182-Y	LG3OEE-840H-L1182-Y	552,00
1475	4000K	On/Off	Low	2240lm/19W	3,5	LG3OWE-840E-L1475-Y	LG3OEE-840E-L1475-Y	622,00
1475	4000K	On/Off	Medium	3030lm/26W	3,5	LG3OWE-840M-L1475-Y	LG3OEE-840M-L1475-Y	622,00
1475	4000K	On/Off	High	4300lm/37W	3,5	LG3OWE-840H-L1475-Y	LG3OEE-840H-L1475-Y	622,00
1765	4000K	On/Off	Low	2690lm/22W	4,0	LG3OWE-840E-L1765-Y	LG3OEE-840E-L1765-Y	751,00
1765	4000K	On/Off	Medium	3640lm/30W	4,0	LG3OWE-840M-L1765-Y	LG3OEE-840M-L1765-Y	751,00
1765	4000K	On/Off	High	5160lm/44W	4,0	LG3OWE-840H-L1765-Y	LG3OEE-840H-L1765-Y	751,00
2055	4000K	On/Off	Low	3140lm/28W	5,5	LG3OWE-840E-L2055-Y	LG3OEE-840E-L2055-Y	909,00
2055	4000K	On/Off	Medium	4250lm/38W	5,5	LG3OWE-840M-L2055-Y	LG3OEE-840M-L2055-Y	909,00
2055	4000K	On/Off	High	6020lm/54W	5,5	LG3OWE-840H-L2055-Y	LG3OEE-840H-L2055-Y	909,00
per meter	4000K	On/Off	Low	1530lm/12,5W	2,8	LG3OWE-840E-L****-Y	LG3OEE-840E-L****-Y	455,00
per meter	4000K	On/Off	Medium	2060lm/17,2W	2,8	LG3OWE-840M-L****-Y	LG3OEE-840M-L****-Y	455,00
per meter	4000K	On/Off	High	2930lm/25,2W	2,8	LG3OWE-840H-L****-Y	LG3OEE-840H-L****-Y	455,00
per meter	4000K	DALI	Low	1530lm/12,5W	2,8	LG3OWL-840E-L****-Y	LG3OEL-840E-L****-Y	508,00
per meter	4000K	DALI	Medium	2060lm/17,2W	2,8	LG3OWL-840M-L****-Y	LG3OEL-840M-L****-Y	508,00
per meter	4000K	DALI	High	2930lm/25,2W	2,8	LG3OWL-840H-L****-Y	LG3OEL-840H-L****-Y	508,00

**** Your length in mm

Meterpreise für Lichtsysteme nach Maß ab Mindestlänge 2200mm | Prices per metre for customised lighting systems with a minimum length of 2200mm
 Prix au mètre pour systèmes d'éclairage sur mesure à partir d'une longueur minimale de 2200mm

Wallwasher | Direct-Indirect

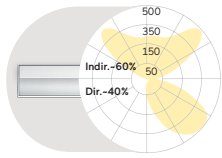

L mm	Colour Temperature	Control	Power	Lumen/Watt	Weight kg	Code Snow White	Code Silver Anodised	CHF
890	4000K	On/Off	Medium	2910lm/26W	3,6	LR3GWE-840M-L890-Y	LR3GEE-840M-L890-Y	788,00
890	4000K	On/Off	High	3980lm/37W	3,6	LR3GWE-840H-L890-Y	LR3GEE-840H-L890-Y	788,00
1182	4000K	On/Off	Medium	3950lm/37W	4,5	LR3GWE-840M-L1182-Y	LR3GEE-840M-L1182-Y	853,00
1182	4000K	On/Off	High	5420lm/51W	4,5	LR3GWE-840H-L1182-Y	LR3GEE-840H-L1182-Y	853,00
1475	4000K	On/Off	Medium	5000lm/45W	5,3	LR3GWE-840M-L1475-Y	LR3GEE-840M-L1475-Y	977,00
1475	4000K	On/Off	High	6850lm/63W	5,3	LR3GWE-840H-L1475-Y	LR3GEE-840H-L1475-Y	977,00
1765	4000K	On/Off	Medium	6040lm/54W	6,2	LR3GWE-840M-L1765-Y	LR3GEE-840M-L1765-Y	1194,00
1765	4000K	On/Off	High	8280lm/75W	6,2	LR3GWE-840H-L1765-Y	LR3GEE-840H-L1765-Y	1194,00
2055	4000K	On/Off	Medium	7090lm/65W	7,5	LR3GWE-840M-L2055-Y	LR3GEE-840M-L2055-Y	1418,00
2055	4000K	On/Off	High	9710lm/91W	7,5	LR3GWE-840H-L2055-Y	LR3GEE-840H-L2055-Y	1418,00
per meter	4000K	On/Off	Medium	3430lm/30,4W	3,9	LR3GWE-840M-L****-Y	LR3GEE-840M-L****-Y	683,00
per meter	4000K	On/Off	High	4700lm/42,7W	3,9	LR3GWE-840H-L****-Y	LR3GEE-840H-L****-Y	683,00
per meter	4000K	DALI	Medium	3430lm/30,4W	3,9	LR3GWL-840M-L****-Y	LR3GEL-840M-L****-Y	753,00
per meter	4000K	DALI	High	4700lm/42,7W	3,9	LR3GWL-840H-L****-Y	LR3GEL-840H-L****-Y	753,00

Wallwasher | Direct

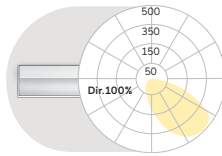

L mm	Colour Temperature	Control	Power	Lumen/Watt	Weight kg	Code Snow White	Code Silver Anodised	CHF
890	4000K	On/Off	Medium	1130lm/15W	2,8	LG3GWE-840M-L890-Y	LG3GEE-840M-L890-Y	567,00
890	4000K	On/Off	High	1540lm/21W	2,8	LG3GWE-840H-L890-Y	LG3GEE-840H-L890-Y	567,00
1182	4000K	On/Off	Medium	1500lm/19W	3,5	LG3GWE-840M-L1182-Y	LG3GEE-840M-L1182-Y	620,00
1182	4000K	On/Off	High	2060lm/27W	3,5	LG3GWE-840H-L1182-Y	LG3GEE-840H-L1182-Y	620,00
1475	4000K	On/Off	Medium	1880lm/23W	4,2	LG3GWE-840M-L1475-Y	LG3GEE-840M-L1475-Y	700,00
1475	4000K	On/Off	High	2570lm/33W	4,2	LG3GWE-840H-L1475-Y	LG3GEE-840H-L1475-Y	700,00
1765	4000K	On/Off	Medium	2250lm/28W	4,8	LG3GWE-840M-L1765-Y	LG3GEE-840M-L1765-Y	849,00
1765	4000K	On/Off	High	3090lm/39W	4,8	LG3GWE-840H-L1765-Y	LG3GEE-840H-L1765-Y	849,00
2055	4000K	On/Off	Medium	2630lm/34W	5,7	LG3GWE-840M-L2055-Y	LG3GEE-840M-L2055-Y	1031,00
2055	4000K	On/Off	High	3600lm/47W	5,7	LG3GWE-840H-L2055-Y	LG3GEE-840H-L2055-Y	1031,00
per meter	4000K	On/Off	Medium	1280lm/15,6W	3,1	LG3GWE-840M-L****-Y	LG3GEE-840M-L****-Y	508,00
per meter	4000K	On/Off	High	1750lm/21,9W	3,1	LG3GWE-840H-L****-Y	LG3GEE-840H-L****-Y	508,00
per meter	4000K	DALI	Medium	1280lm/15,6W	3,1	LG3GWL-840M-L****-Y	LG3GEL-840M-L****-Y	560,00
per meter	4000K	DALI	High	1750lm/21,9W	3,1	LG3GWL-840H-L****-Y	LG3GEL-840H-L****-Y	560,00

**** Your length in mm
 Meterpreise für Lichtsysteme nach Maß ab Mindestlänge 2200mm
 Prices per metre for customised lighting systems with a minimum length of 2200mm
 Prix au mètre pour systèmes d'éclairage sur mesure à partir d'une longueur minimale de 2200mm



90° Corner
Opal/Microprismatic

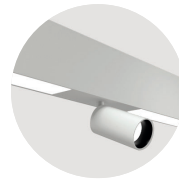

Midpin Spotlight XM
770lm/10W/Ø40mm

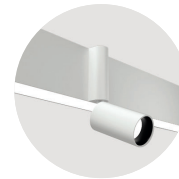

Midpin Spotlight XP
770lm/10W/Ø40mm



Multisensor

Surcharges

Optical System	CHF	Surface Finish	CHF	Control Gear	CHF L890-L1765	CHF L2055	Colour Temperature	CHF	Lens Louvre*	CHF
O: Opal Diffuser (PMMA)	✓	W: Snow White	✓	E: On/Off	✓	✓	22: 2200K	+5%	W: Snow White	✓
D: Opal Diffuser Polycarbonate*	+5%	E: Silver Anodised	✓	L: DALI	+86,00	+172,00	27: 2700K	+5%	A: Satin Silver	✓
*Opal Diffuser made of sustainable Trucircle Polycarbonate / Fire Rated - Glow wire flammability Index 950°C EN60695-2-12/ Tp(a). Luminous flux reduction of 10%.		U: Urban Graphite	✓	H: Touch-Dim	+86,00	+172,00	30: 3000K	✓	B: Jet Black	✓
		B: Jet Black	✓	C: Casambi	+261,00	+261,00	35: 3500K	+5%	H: Anodic Champagne	✓
		H: Anodic Champagne	+10%	6: DALI DT6 for TW [L1475-L2055]	+172,00	+343,00	40: 4000K	✓	K: Satin Copper	✓
		K: Satin Copper	+15%	8: DALI DT8 for TW	+172,00	+343,00	65: 6500K	+5%	G: Satin Gold	✓
		R: Special RAL/NCS Colours	🚫	*Only in combination with DALI. Please add to dimming price.			TW: Tunable White 2700-6500K**	+30%	Additional Options	
				Colour Rendering	CHF				90° Corner	🚫
				8: CRI>80	✓				Midpin Spotlight XM	+363,00
				9: CRI>90	+5%				Midpin Spotlight XP	+433,00
				F: Full Spectrum	+15%				Multisensor [L1182-L2055]	+261,00
									Emergency Module [DALI, Autotest, incl. 3H Battery] [L1182-L2055]	+366,00

✓ standard / no extra charge 🚫 on request 🚫 not available

Matric System R4 | 55mm Suspended

catalogue page 314

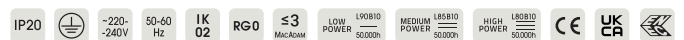
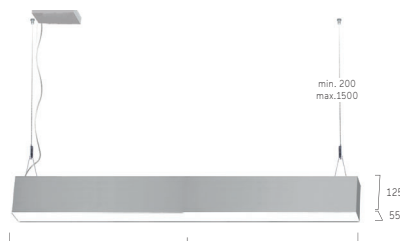
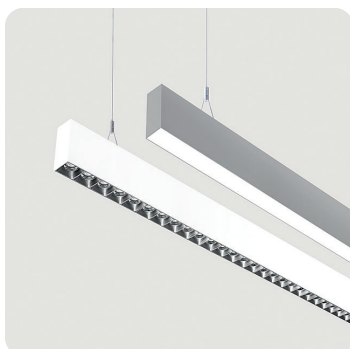

... Matric System R4 | 55mm Suspended

Lens Louvre | Direct-Indirect

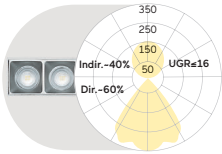

L mm	Colour Temperature	Control	Power	Lumen/Watt	Weight kg	Code Snow White/Jet Black	Code Silver Anodised/Jet Black	CHF
1002	4000K	Sep. Switch.	Medium	4300lm/34W	5,1	LR4LWG-840M-L1002-YB*	LR4LEG-840M-L1002-YB*	907,00
1002	4000K	Sep. Switch.	High	6050lm/48W	5,1	LR4LWG-840H-L1002-YB*	LR4LEG-840H-L1002-YB*	907,00
1252	4000K	Sep. Switch.	Medium	5510lm/42W	6,0	LR4LWG-840M-L1252-YB*	LR4LEG-840M-L1252-YB*	1038,00
1252	4000K	Sep. Switch.	High	7780lm/61W	6,0	LR4LWG-840H-L1252-YB*	LR4LEG-840H-L1252-YB*	1038,00
1502	4000K	Sep. Switch.	Medium	6540lm/49W	7,0	LR4LWG-840M-L1502-YB*	LR4LEG-840M-L1502-YB*	1220,00
1502	4000K	Sep. Switch.	High	9210lm/71W	7,0	LR4LWG-840H-L1502-YB*	LR4LEG-840H-L1502-YB*	1220,00
1752	4000K	Sep. Switch.	Medium	7760lm/57W	7,9	LR4LWG-840M-L1752-YB*	LR4LEG-840M-L1752-YB*	1428,00
1752	4000K	Sep. Switch.	High	10930lm/83W	7,9	LR4LWG-840H-L1752-YB*	LR4LEG-840H-L1752-YB*	1428,00
2002	4000K	Sep. Switch.	Medium	8790lm/63W	9,4	LR4LWG-840M-L2002-YB*	LR4LEG-840M-L2002-YB*	1693,00
2002	4000K	Sep. Switch.	High	12380lm/96W	9,4	LR4LWG-840H-L2002-YB*	LR4LEG-840H-L2002-YB*	1693,00
per meter	4000K	Sep. Switch.	Medium	4430lm/32,2W	5,1	LR4LWG-840M-L****-YB*	LR4LEG-840M-L****-YB*	832,00
per meter	4000K	Sep. Switch.	High	6250lm/47,3W	5,1	LR4LWG-840H-L****-YB*	LR4LEG-840H-L****-YB*	832,00
per meter	4000K	Sep. Dim. DALI	Medium	4430lm/32,2W	5,1	LR4LWU-840M-L****-YB*	LR4LEU-840M-L****-YB*	902,00
per meter	4000K	Sep. Dim. DALI	High	6250lm/47,3W	5,1	LR4LWU-840H-L****-YB*	LR4LEU-840H-L****-YB*	902,00

Microprismatic | Direct-Indirect

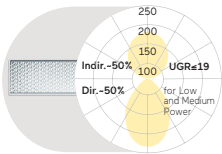

L mm	Colour Temperature	Control	Power	Lumen/Watt	Weight kg	Code Snow White	Code Silver Anodised	CHF
890	4000K	Sep. Switch.	Low	2370lm/22W	4,4	LR4AWG-840E-L890-Y	LR4AEG-840E-L890-Y	832,00
890	4000K	Sep. Switch.	Medium	3260lm/30W	4,4	LR4AWG-840M-L890-Y	LR4AEG-840M-L890-Y	832,00
890	4000K	Sep. Switch.	High	4540lm/42W	4,4	LR4AWG-840H-L890-Y	LR4AEG-840H-L890-Y	832,00
1182	4000K	Sep. Switch.	Low	3200lm/28W	5,5	LR4AWG-840E-L1182-Y	LR4AEG-840E-L1182-Y	888,00
1182	4000K	Sep. Switch.	Medium	4410lm/39W	5,5	LR4AWG-840M-L1182-Y	LR4AEG-840M-L1182-Y	888,00
1182	4000K	Sep. Switch.	High	6140lm/55W	5,5	LR4AWG-840H-L1182-Y	LR4AEG-840H-L1182-Y	888,00
1475	4000K	Sep. Switch.	Low	4040lm/35W	6,5	LR4AWG-840E-L1475-Y	LR4AEG-840E-L1475-Y	1021,00
1475	4000K	Sep. Switch.	Medium	5560lm/48W	6,5	LR4AWG-840M-L1475-Y	LR4AEG-840M-L1475-Y	1021,00
1475	4000K	Sep. Switch.	High	7750lm/68W	6,5	LR4AWG-840H-L1475-Y	LR4AEG-840H-L1475-Y	1021,00
1765	4000K	Sep. Switch.	Low	4870lm/41W	7,6	LR4AWG-840E-L1765-Y	LR4AEG-840E-L1765-Y	1227,00
1765	4000K	Sep. Switch.	Medium	6710lm/56W	7,6	LR4AWG-840M-L1765-Y	LR4AEG-840M-L1765-Y	1227,00
1765	4000K	Sep. Switch.	High	9350lm/81W	7,6	LR4AWG-840H-L1765-Y	LR4AEG-840H-L1765-Y	1227,00
2055	4000K	Sep. Switch.	Low	5700lm/50W	9,1	LR4AWG-840E-L2055-Y	LR4AEG-840E-L2055-Y	1465,00
2055	4000K	Sep. Switch.	Medium	7860lm/69W	9,1	LR4AWG-840M-L2055-Y	LR4AEG-840M-L2055-Y	1465,00
2055	4000K	Sep. Switch.	High	10960lm/98W	9,1	LR4AWG-840H-L2055-Y	LR4AEG-840H-L2055-Y	1465,00
per meter	4000K	Sep. Switch.	Low	2760lm/23,1W	4,9	LR4AWG-840E-L****-Y	LR4AEG-840E-L****-Y	692,00
per meter	4000K	Sep. Switch.	Medium	3810lm/32,0W	4,9	LR4AWG-840M-L****-Y	LR4AEG-840M-L****-Y	692,00
per meter	4000K	Sep. Switch.	High	5300lm/45,9W	4,9	LR4AWG-840H-L****-Y	LR4AEG-840H-L****-Y	692,00
per meter	4000K	Sep. Dim. DALI	Low	2760lm/23,1W	4,9	LR4AWU-840E-L****-Y	LR4AEU-840E-L****-Y	762,00
per meter	4000K	Sep. Dim. DALI	Medium	3810lm/32,0W	4,9	LR4AWU-840M-L****-Y	LR4AEU-840M-L****-Y	762,00
per meter	4000K	Sep. Dim. DALI	High	5300lm/45,9W	4,9	LR4AWU-840H-L****-Y	LR4AEU-840H-L****-Y	762,00

Opal Diffuser | Direct-Indirect

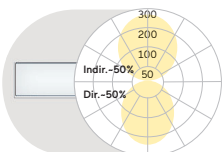

L mm	Colour Temperature	Control	Power	Lumen/Watt	Weight kg	Code Snow White	Code Silver Anodised	CHF
890	4000K	Sep. Switch.	Low	2490lm/22W	4,4	LR4OWG-840E-L890-Y	LR4OEG-840E-L890-Y	812,00
890	4000K	Sep. Switch.	Medium	3420lm/30W	4,4	LR4OWG-840M-L890-Y	LR4OEG-840M-L890-Y	812,00
890	4000K	Sep. Switch.	High	4770lm/42W	4,4	LR4OWG-840H-L890-Y	LR4OEG-840H-L890-Y	812,00
1182	4000K	Sep. Switch.	Low	3350lm/28W	5,5	LR4OWG-840E-L1182-Y	LR4OEG-840E-L1182-Y	861,00
1182	4000K	Sep. Switch.	Medium	4630lm/39W	5,5	LR4OWG-840M-L1182-Y	LR4OEG-840M-L1182-Y	861,00
1182	4000K	Sep. Switch.	High	6450lm/55W	5,5	LR4OWG-840H-L1182-Y	LR4OEG-840H-L1182-Y	861,00
1475	4000K	Sep. Switch.	Low	4230lm/35W	6,5	LR4OWG-840E-L1475-Y	LR4OEG-840E-L1475-Y	982,00
1475	4000K	Sep. Switch.	Medium	5820lm/48W	6,5	LR4OWG-840M-L1475-Y	LR4OEG-840M-L1475-Y	982,00
1475	4000K	Sep. Switch.	High	8130lm/68W	6,5	LR4OWG-840H-L1475-Y	LR4OEG-840H-L1475-Y	982,00
1765	4000K	Sep. Switch.	Low	5110lm/41W	7,6	LR4OWG-840E-L1765-Y	LR4OEG-840E-L1765-Y	1171,00
1765	4000K	Sep. Switch.	Medium	7030lm/56W	7,6	LR4OWG-840M-L1765-Y	LR4OEG-840M-L1765-Y	1171,00
1765	4000K	Sep. Switch.	High	9810lm/81W	7,6	LR4OWG-840H-L1765-Y	LR4OEG-840H-L1765-Y	1171,00
2055	4000K	Sep. Switch.	Low	5980lm/50W	9,1	LR4OWG-840E-L2055-Y	LR4OEG-840E-L2055-Y	1399,00
2055	4000K	Sep. Switch.	Medium	8240lm/69W	9,1	LR4OWG-840M-L2055-Y	LR4OEG-840M-L2055-Y	1399,00
2055	4000K	Sep. Switch.	High	11490lm/98W	9,1	LR4OWG-840H-L2055-Y	LR4OEG-840H-L2055-Y	1399,00
per meter	4000K	Sep. Switch.	Low	2900lm/23,1W	4,9	LR4OWG-840E-L****-Y	LR4OEG-840E-L****-Y	674,00
per meter	4000K	Sep. Switch.	Medium	3990lm/32,0W	4,9	LR4OWG-840M-L****-Y	LR4OEG-840M-L****-Y	674,00
per meter	4000K	Sep. Switch.	High	5560lm/45,9W	4,9	LR4OWG-840H-L****-Y	LR4OEG-840H-L****-Y	674,00
per meter	4000K	Sep. Dim. DALI	Low	2900lm/23,1W	4,9	LR4OWU-840E-L****-Y	LR4OEU-840E-L****-Y	744,00
per meter	4000K	Sep. Dim. DALI	Medium	3990lm/32,0W	4,9	LR4OWU-840M-L****-Y	LR4OEU-840M-L****-Y	744,00
per meter	4000K	Sep. Dim. DALI	High	5560lm/45,9W	4,9	LR4OWU-840H-L****-Y	LR4OEU-840H-L****-Y	744,00

Wallwasher | Direct-Indirect

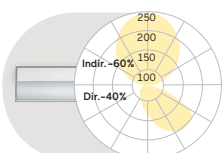

L mm	Colour Temperature	Control	Power	Lumen/Watt	Weight kg	Code Snow White	Code Silver Anodised	CHF
890	4000K	Sep. Switch.	Medium	2730lm/26W	4,5	LR4GWG-840M-L890-Y	LR4GEG-840M-L890-Y	851,00
890	4000K	Sep. Switch.	High	3730lm/37W	4,5	LR4GWG-840H-L890-Y	LR4GEG-840H-L890-Y	851,00
1182	4000K	Sep. Switch.	Medium	3700lm/37W	5,6	LR4GWG-840M-L1182-Y	LR4GEG-840M-L1182-Y	921,00
1182	4000K	Sep. Switch.	High	5070lm/51W	5,6	LR4GWG-840H-L1182-Y	LR4GEG-840H-L1182-Y	921,00
1475	4000K	Sep. Switch.	Medium	4670lm/45W	6,7	LR4GWG-840M-L1475-Y	LR4GEG-840M-L1475-Y	1056,00
1475	4000K	Sep. Switch.	High	6400lm/63W	6,7	LR4GWG-840H-L1475-Y	LR4GEG-840H-L1475-Y	1056,00
1765	4000K	Sep. Switch.	Medium	5640lm/54W	7,8	LR4GWG-840M-L1765-Y	LR4GEG-840M-L1765-Y	1290,00
1765	4000K	Sep. Switch.	High	7740lm/75W	7,8	LR4GWG-840H-L1765-Y	LR4GEG-840H-L1765-Y	1290,00
2055	4000K	Sep. Switch.	Medium	6620lm/65W	9,3	LR4GWG-840M-L2055-Y	LR4GEG-840M-L2055-Y	1532,00
2055	4000K	Sep. Switch.	High	9070lm/91W	9,3	LR4GWG-840H-L2055-Y	LR4GEG-840H-L2055-Y	1532,00
per meter	4000K	Sep. Switch.	Medium	3200lm/30,4W	4,9	LR4GWG-840M-L****-Y	LR4GEG-840M-L****-Y	727,00
per meter	4000K	Sep. Switch.	High	4390lm/42,7W	4,9	LR4GWG-840H-L****-Y	LR4GEG-840H-L****-Y	727,00
per meter	4000K	Sep. Dim. DALI	Medium	3200lm/30,4W	4,9	LR4GWU-840M-L****-Y	LR4GEU-840M-L****-Y	797,00
per meter	4000K	Sep. Dim. DALI	High	4390lm/42,7W	4,9	LR4GWU-840H-L****-Y	LR4GEU-840H-L****-Y	797,00

**** Your length in mm
 Meterpreise für Lichtsysteme nach Maß ab Mindestlänge 2200mm | Prices per metre for customised lighting systems with a minimum length of 2200mm
 Prix au mètre pour systèmes d'éclairage sur mesure à partir d'une longueur minimale de 2200mm



90° Corner
Opal/Micropismatic

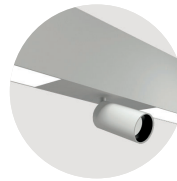

Midpin Spotlight XM
770lm/10W/Ø40mm



Midpin Spotlight XP
770lm/10W/Ø40mm



Multisensor

Surcharges

Optical System	CHF	Surface Finish	CHF	Control Gear	CHF L890-L1765	CHF L2055	Colour Temperature	CHF	Lens Louvre*	CHF
O: Opal Diffuser (PMMA)	✓	W: Snow White	✓	G: Separately Switchable	✓	✓	22: 2200K	+5%	W: Snow White	✓
D: Opal Diffuser Polycarbonate*	+5%	E: Silver Anodised	✓	U: Separately Dimmable DALI	+172,00	+343,00	27: 2700K	+5%	A: Satin Silver	✓
		U: Urban Graphite	✓	H: Touch-Dim	+172,00	+343,00	30: 3000K	✓	B: Jet Black	✓
		B: Jet Black	✓	C: Casambi*	+261,00	+261,00	35: 3500K	+5%	H: Anodic Champagne	✓
*Opal Diffuser made of sustainable Trucircle Polycarbonate / Fire Rated - Glow wire flammability Index 950°C EN60695-2-12/ Tp(a). Luminous flux reduction of 10%.		H: Anodic Champagne	+10%	6: DALI DT6 for TW [L1475-L2055]	+343,00	+686,00	40: 4000K	✓	K: Satin Copper	✓
		K: Satin Copper	+15%	8: DALI DT8 for TW	+343,00	+686,00	65: 6500K	+5%	G: Satin Gold	✓
		R: Special RAL/NCS Colours	🔴				TW: Tunable White 2700-6500K**	+30%		
									Additional Options	CHF
									90° Corner	🔴
									Midpin Spotlight XM	+363,00
									Midpin Spotlight XP	+433,00
									Multisensor [L1182-L2055]	+261,00
									Emergency Module [DALI, Autotest, incl. 3H Battery] [L1182-L2055]	+366,00
				Colour Rendering	CHF					
				8: CRI>80	✓					
				9: CRI>90	+5%					
				F: Full Spectrum	+15%					

✓ standard / no extra charge 🔴 on request ✗ not available

Matric System G5 | 81mm Suspended

catalogue page 316

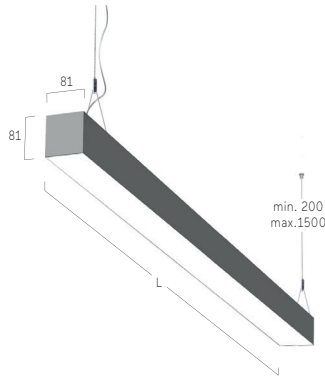

Microprismatic | Direct

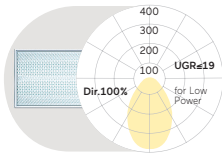

L mm	Colour Temperature	Control	Power	Lumen/Watt	Weight kg	Code Snow White	Code Silver Anodised	CHF
890	4000K	On/Off	Low	1510lm/15W	3,5	LG5AWE-840E-L890-Y	LG5AEE-840E-L890-Y	559,00
890	4000K	On/Off	Medium	2070lm/21W	3,5	LG5AWE-840M-L890-Y	LG5AEE-840M-L890-Y	559,00
890	4000K	On/Off	High	3020lm/31W	3,5	LG5AWE-840H-L890-Y	LG5AEE-840H-L890-Y	559,00
1182	4000K	On/Off	Low	2010lm/19W	4,3	LG5AWE-840E-L1182-Y	LG5AEE-840E-L1182-Y	606,00
1182	4000K	On/Off	Medium	2760lm/26W	4,3	LG5AWE-840M-L1182-Y	LG5AEE-840M-L1182-Y	606,00
1182	4000K	On/Off	High	4020lm/40W	4,3	LG5AWE-840H-L1182-Y	LG5AEE-840H-L1182-Y	606,00
1475	4000K	On/Off	Low	2510lm/23W	5,2	LG5AWE-840E-L1475-Y	LG5AEE-840E-L1475-Y	692,00
1475	4000K	On/Off	Medium	3450lm/32W	5,2	LG5AWE-840M-L1475-Y	LG5AEE-840M-L1475-Y	692,00
1475	4000K	On/Off	High	5030lm/49W	5,2	LG5AWE-840H-L1475-Y	LG5AEE-840H-L1475-Y	692,00
1765	4000K	On/Off	Low	3010lm/27W	6,0	LG5AWE-840E-L1765-Y	LG5AEE-840E-L1765-Y	849,00
1765	4000K	On/Off	Medium	4140lm/38W	6,0	LG5AWE-840M-L1765-Y	LG5AEE-840M-L1765-Y	849,00
1765	4000K	On/Off	High	6030lm/59W	6,0	LG5AWE-840H-L1765-Y	LG5AEE-840H-L1765-Y	849,00
2055	4000K	On/Off	Low	3510lm/34W	7,0	LG5AWE-840E-L2055-Y	LG5AEE-840E-L2055-Y	1042,00
2055	4000K	On/Off	Medium	4830lm/47W	7,0	LG5AWE-840M-L2055-Y	LG5AEE-840M-L2055-Y	1042,00
2055	4000K	On/Off	High	7040lm/71W	7,0	LG5AWE-840H-L2055-Y	LG5AEE-840H-L2055-Y	1042,00
per meter	4000K	On/Off	Low	1710lm/15,5W	3,8	LG5AWE-840E-L****-Y	LG5AEE-840E-L****-Y	525,00
per meter	4000K	On/Off	Medium	2350lm/21,7W	3,8	LG5AWE-840M-L****-Y	LG5AEE-840M-L****-Y	525,00
per meter	4000K	On/Off	High	3420lm/33,3W	3,8	LG5AWE-840H-L****-Y	LG5AEE-840H-L****-Y	525,00
per meter	4000K	DALI	Low	1710lm/15,5W	3,8	LG5AWL-840E-L****-Y	LG5AEL-840E-L****-Y	578,00
per meter	4000K	DALI	Medium	2350lm/21,7W	3,8	LG5AWL-840M-L****-Y	LG5AEL-840M-L****-Y	578,00
per meter	4000K	DALI	High	3420lm/33,3W	3,8	LG5AWL-840H-L****-Y	LG5AEL-840H-L****-Y	578,00

**** Your length in mm
 Meterpreise für Lichtsysteme nach Maß ab Mindestlänge 2200mm | Prices per metre for customised lighting systems with a minimum length of 2200mm
 Prix au mètre pour systèmes d'éclairage sur mesure à partir d'une longueur minimale de 2200mm

... Matric System G5 | 81mm Suspended

Opal Diffuser | Direct

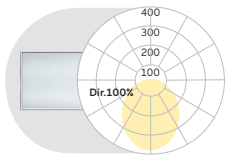

L mm	Colour Temperature	Control	Power	Lumen/Watt	Weight kg	Code Snow White	Code Silver Anodised	CHF
890	4000K	On/Off	Low	1760lm/15W	3,5	LG5OWE-840E-L890-Y	LG5OEE-840E-L890-Y	541,00
890	4000K	On/Off	Medium	2430lm/21W	3,5	LG5OWE-840M-L890-Y	LG5OEE-840M-L890-Y	541,00
890	4000K	On/Off	High	3530lm/31W	3,5	LG5OWE-840H-L890-Y	LG5OEE-840H-L890-Y	541,00
1182	4000K	On/Off	Low	2350lm/19W	4,3	LG5OWE-840E-L1182-Y	LG5OEE-840E-L1182-Y	578,00
1182	4000K	On/Off	Medium	3230lm/26W	4,3	LG5OWE-840M-L1182-Y	LG5OEE-840M-L1182-Y	578,00
1182	4000K	On/Off	High	4710lm/40W	4,3	LG5OWE-840H-L1182-Y	LG5OEE-840H-L1182-Y	578,00
1475	4000K	On/Off	Low	2940lm/23W	5,2	LG5OWE-840E-L1475-Y	LG5OEE-840E-L1475-Y	657,00
1475	4000K	On/Off	Medium	4040lm/32W	5,2	LG5OWE-840M-L1475-Y	LG5OEE-840M-L1475-Y	657,00
1475	4000K	On/Off	High	5890lm/49W	5,2	LG5OWE-840H-L1475-Y	LG5OEE-840H-L1475-Y	657,00
1765	4000K	On/Off	Low	3530lm/27W	6,0	LG5OWE-840E-L1765-Y	LG5OEE-840E-L1765-Y	804,00
1765	4000K	On/Off	Medium	4850lm/38W	6,0	LG5OWE-840M-L1765-Y	LG5OEE-840M-L1765-Y	804,00
1765	4000K	On/Off	High	7070lm/59W	6,0	LG5OWE-840H-L1765-Y	LG5OEE-840H-L1765-Y	804,00
2055	4000K	On/Off	Low	4120lm/34W	7,0	LG5OWE-840E-L2055-Y	LG5OEE-840E-L2055-Y	979,00
2055	4000K	On/Off	Medium	5660lm/47W	7,0	LG5OWE-840M-L2055-Y	LG5OEE-840M-L2055-Y	979,00
2055	4000K	On/Off	High	8240lm/71W	7,0	LG5OWE-840H-L2055-Y	LG5OEE-840H-L2055-Y	979,00
per meter	4000K	On/Off	Low	2000lm/15,5W	3,8	LG5OWE-840E-L****-Y	LG5OEE-840E-L****-Y	490,00
per meter	4000K	On/Off	Medium	2750lm/21,7W	3,8	LG5OWE-840M-L****-Y	LG5OEE-840M-L****-Y	490,00
per meter	4000K	On/Off	High	4010lm/33,3W	3,8	LG5OWE-840H-L****-Y	LG5OEE-840H-L****-Y	490,00
per meter	4000K	DALI	Low	2000lm/15,5W	3,8	LG5OWL-840E-L****-Y	LG5OEL-840E-L****-Y	543,00
per meter	4000K	DALI	Medium	2750lm/21,7W	3,8	LG5OWL-840M-L****-Y	LG5OEL-840M-L****-Y	543,00
per meter	4000K	DALI	High	4010lm/33,3W	3,8	LG5OWL-840H-L****-Y	LG5OEL-840H-L****-Y	543,00

Satin Louvre | Direct

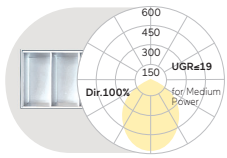

L mm	Colour Temperature	Control	Power	Lumen/Watt	Weight kg	Code Snow White	Code Silver Anodised	CHF
890	4000K	On/Off	Medium	1900lm/21W	3,5	LG5MWE-840M-L890-Y	LG5MEE-840M-L890-Y	585,00
890	4000K	On/Off	High	2770lm/31W	3,5	LG5MWE-840H-L890-Y	LG5MEE-840H-L890-Y	585,00
1182	4000K	On/Off	Medium	2530lm/26W	4,3	LG5MWE-840M-L1182-Y	LG5MEE-840M-L1182-Y	632,00
1182	4000K	On/Off	High	3690lm/40W	4,3	LG5MWE-840H-L1182-Y	LG5MEE-840H-L1182-Y	632,00
1475	4000K	On/Off	Medium	3170lm/32W	5,2	LG5MWE-840M-L1475-Y	LG5MEE-840M-L1475-Y	693,00
1475	4000K	On/Off	High	4610lm/49W	5,2	LG5MWE-840H-L1475-Y	LG5MEE-840H-L1475-Y	693,00
1765	4000K	On/Off	Medium	3800lm/38W	6,0	LG5MWE-840M-L1765-Y	LG5MEE-840M-L1765-Y	788,00
1765	4000K	On/Off	High	5530lm/59W	6,0	LG5MWE-840H-L1765-Y	LG5MEE-840H-L1765-Y	788,00
2055	4000K	On/Off	Medium	4430lm/47W	7,0	LG5MWE-840M-L2055-Y	LG5MEE-840M-L2055-Y	982,00
2055	4000K	On/Off	High	6450lm/71W	7,0	LG5MWE-840H-L2055-Y	LG5MEE-840H-L2055-Y	982,00

Wallwasher | Direct

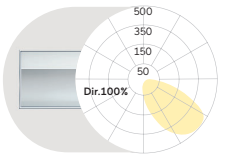

L mm	Colour Temperature	Control	Power	Lumen/Watt	Weight kg	Code Snow White	Code Silver Anodised	CHF
890	4000K	On/Off	High	1770lm/21W	3,6	LG5GWE-840H-L890-Y	LG5GEE-840H-L890-Y	585,00
1182	4000K	On/Off	High	2360lm/27W	4,4	LG5GWE-840H-L1182-Y	LG5GEE-840H-L1182-Y	632,00
1475	4000K	On/Off	High	2950lm/33W	5,3	LG5GWE-840H-L1475-Y	LG5GEE-840H-L1475-Y	693,00
1765	4000K	On/Off	High	3540lm/39W	6,1	LG5GWE-840H-L1765-Y	LG5GEE-840H-L1765-Y	858,00
2055	4000K	On/Off	High	4130lm/47W	7,2	LG5GWE-840H-L2055-Y	LG5GEE-840H-L2055-Y	1068,00
per meter	4000K	On/Off	High	2010lm/21,9W	3,9	LG5GWE-840H-L****-Y	LG5GEE-840H-L****-Y	517,00
per meter	4000K	DALI	High	2010lm/21,9W	3,9	LG5GWL-840H-L****-Y	LG5GEL-840H-L****-Y	569,00

**** Your length in mm

Meterpreise für Lichtsysteme nach Maß ab Mindestlänge 2200mm | Prices per metre for customised lighting systems with a minimum length of 2200mm
 Prix au mètre pour systèmes d'éclairage sur mesure à partir d'une longueur minimale de 2200mm



90° Corner
Opal/Micropismatic

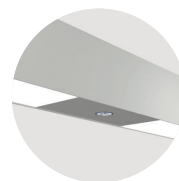

Midpin Downlight XD
770lm/10W/Ø40mm

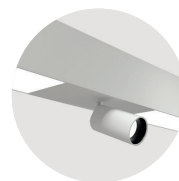

Midpin Spotlight XM
770lm/10W/Ø40mm

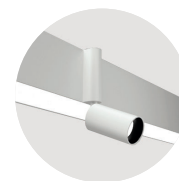

Midpin Spotlight XP
770lm/10W/Ø40mm



Multisensor

Surcharges

Surface Finish	CHF	Control Gear	CHF L890-L1765	CHF L2055	Colour Rendering	CHF	Colour Temperature	CHF	Additional Options	CHF
W: Snow White	✓	E: On/Off	✓	✓	8: CRI>80	✓	22: 2200K	+5%	90° Corner	⚠
V: Ivory White	✓	L: DALI	+86,00	+172,00	9: CRI>90	+5%	27: 2700K	+5%	Midpin Downlight XD	+363,00
E: Silver Anodised	✓	H: Touch-Dim	+86,00	+172,00	F: Full Spectrum	+15%	30: 3000K	✓	Midpin Spotlight XM	+363,00
U: Urban Graphite	✓	C: Casambi*	+261,00	+261,00			35: 3500K	+5%	Midpin Spotlight XP	+433,00
B: Jet Black	✓	6: DALI DT6 for TW [L1475-L2055]	+172,00	+343,00			40: 4000K	✓	Multisensor [L1182-L2055]	+261,00
H: Anodic Champagne	+10%	8: DALI DT8 for TW	+172,00	+343,00			65: 6500K	+5%	Emergency Module [DALI, Autotest, incl. 3H Battery]	+366,00
K: Satin Copper	+15%						TW: Tunable White 2700-6500K**	+30%		
R: Special RAL/NCS Colours	⚠									

*Only in combination with DALI. Please add to dimming price.

**Only in combination with DT6, DT8 or Casambi control. Please add additional control price.

✓ standard / no extra charge ⚠ on request ✗ not available

Matric G6/R6 | System 81mm Suspended

catalogue page 318

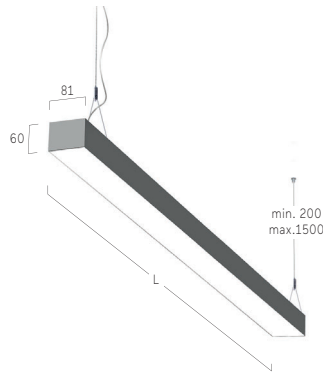
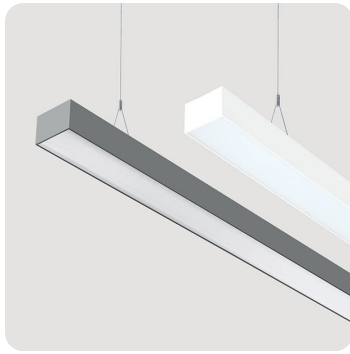

Microprismatic | Direct-Indirect

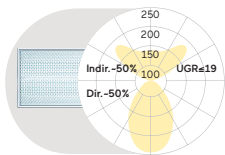

L mm	Colour Temperature	Control	Power	Lumen/Watt	Weight kg	Code Snow White	Code Silver Anodised	CHF
890	4000K	On/Off	Low	2990lm/26W	3,5	LR6AWE-840E-L890-Y	LR6AEE-840E-L890-Y	821,00
890	4000K	On/Off	Medium	4080lm/34W	3,5	LR6AWE-840M-L890-Y	LR6AEE-840M-L890-Y	821,00
890	4000K	On/Off	High	5520lm/46W	3,5	LR6AWE-840H-L890-Y	LR6AEE-840H-L890-Y	821,00
1182	4000K	On/Off	Low	3980lm/33W	4,3	LR6AWE-840E-L1182-Y	LR6AEE-840E-L1182-Y	919,00
1182	4000K	On/Off	Medium	5440lm/44W	4,3	LR6AWE-840M-L1182-Y	LR6AEE-840M-L1182-Y	919,00
1182	4000K	On/Off	High	7370lm/61W	4,3	LR6AWE-840H-L1182-Y	LR6AEE-840H-L1182-Y	919,00
1475	4000K	On/Off	Low	4980lm/40W	5,1	LR6AWE-840E-L1475-Y	LR6AEE-840E-L1475-Y	1031,00
1475	4000K	On/Off	Medium	6800lm/54W	5,1	LR6AWE-840M-L1475-Y	LR6AEE-840M-L1475-Y	1031,00
1475	4000K	On/Off	High	9210lm/74W	5,1	LR6AWE-840H-L1475-Y	LR6AEE-840H-L1475-Y	1031,00
1765	4000K	On/Off	Low	5970lm/47W	5,8	LR6AWE-840E-L1765-Y	LR6AEE-840E-L1765-Y	1206,00
1765	4000K	On/Off	Medium	8160lm/64W	5,8	LR6AWE-840M-L1765-Y	LR6AEE-840M-L1765-Y	1206,00
1765	4000K	On/Off	High	11060lm/88W	5,8	LR6AWE-840H-L1765-Y	LR6AEE-840H-L1765-Y	1206,00
2055	4000K	On/Off	Low	6970lm/56W	6,9	LR6AWE-840E-L2055-Y	LR6AEE-840E-L2055-Y	1497,00
2055	4000K	On/Off	Medium	9520lm/76W	6,9	LR6AWE-840M-L2055-Y	LR6AEE-840M-L2055-Y	1497,00
2055	4000K	On/Off	High	12900lm/104W	6,9	LR6AWE-840H-L2055-Y	LR6AEE-840H-L2055-Y	1497,00
per meter	4000K	On/Off	Low	3390lm/26,2W	3,8	LR6AWE-840E-L****-Y	LR6AEE-840E-L****-Y	727,00
per meter	4000K	On/Off	Medium	4630lm/35,9W	3,8	LR6AWE-840M-L****-Y	LR6AEE-840M-L****-Y	727,00
per meter	4000K	On/Off	High	6290lm/49,4W	3,8	LR6AWE-840H-L****-Y	LR6AEE-840H-L****-Y	727,00
per meter	4000K	DALI	Low	3390lm/26,2W	3,8	LR6AWL-840E-L****-Y	LR6AEL-840E-L****-Y	797,00
per meter	4000K	DALI	Medium	4630lm/35,9W	3,8	LR6AWL-840M-L****-Y	LR6AEL-840M-L****-Y	797,00
per meter	4000K	DALI	High	6290lm/49,4W	3,8	LR6AWL-840H-L****-Y	LR6AEL-840H-L****-Y	797,00

Microprismatic | Direct

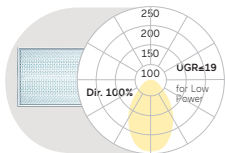

L mm	Colour Temperature	Control	Power	Lumen/Watt	Weight kg	Code Snow White	Code Silver Anodised	CHF
890	4000K	On/Off	Low	1580lm/15W	3,0	LG6AWE-840E-L890-Y	LG6AEE-840E-L890-Y	716,00
890	4000K	On/Off	Medium	2110lm/19W	3,0	LG6AWE-840M-L890-Y	LG6AEE-840M-L890-Y	716,00
890	4000K	On/Off	High	2840lm/26W	3,0	LG6AWE-840H-L890-Y	LG6AEE-840H-L890-Y	716,00
1182	4000K	On/Off	Low	2100lm/19W	3,7	LG6AWE-840E-L1182-Y	LG6AEE-840E-L1182-Y	779,00
1182	4000K	On/Off	Medium	2810lm/25W	3,7	LG6AWE-840M-L1182-Y	LG6AEE-840M-L1182-Y	779,00
1182	4000K	On/Off	High	3790lm/34W	3,7	LG6AWE-840H-L1182-Y	LG6AEE-840H-L1182-Y	779,00
1475	4000K	On/Off	Low	2630lm/23W	4,5	LG6AWE-840E-L1475-Y	LG6AEE-840E-L1475-Y	865,00
1475	4000K	On/Off	Medium	3510lm/31W	4,5	LG6AWE-840M-L1475-Y	LG6AEE-840M-L1475-Y	865,00
1475	4000K	On/Off	High	4740lm/42W	4,5	LG6AWE-840H-L1475-Y	LG6AEE-840H-L1475-Y	865,00
1765	4000K	On/Off	Low	3150lm/27W	5,2	LG6AWE-840E-L1765-Y	LG6AEE-840E-L1765-Y	970,00
1765	4000K	On/Off	Medium	4220lm/36W	5,2	LG6AWE-840M-L1765-Y	LG6AEE-840M-L1765-Y	970,00
1765	4000K	On/Off	High	5690lm/49W	5,2	LG6AWE-840H-L1765-Y	LG6AEE-840H-L1765-Y	970,00
2055	4000K	On/Off	Low	3680lm/31W	6,2	LG6AWE-840E-L2055-Y	LG6AEE-840E-L2055-Y	1206,00
2055	4000K	On/Off	Medium	4920lm/42W	6,2	LG6AWE-840M-L2055-Y	LG6AEE-840M-L2055-Y	1206,00
2055	4000K	On/Off	High	6640lm/57W	6,2	LG6AWE-840H-L2055-Y	LG6AEE-840H-L2055-Y	1206,00
per meter	4000K	On/Off	Low	1790lm/15,1W	3,3	LG6AWE-840E-L****-Y	LG6AEE-840E-L****-Y	587,00
per meter	4000K	On/Off	Medium	2400lm/20,2W	3,3	LG6AWE-840M-L****-Y	LG6AEE-840M-L****-Y	587,00
per meter	4000K	On/Off	High	3240lm/27,4W	3,3	LG6AWE-840H-L****-Y	LG6AEE-840H-L****-Y	587,00
per meter	4000K	DALI	Low	1790lm/15,1W	3,3	LG6AWL-840E-L****-Y	LG6AEL-840E-L****-Y	639,00
per meter	4000K	DALI	Medium	2400lm/20,2W	3,3	LG6AWL-840M-L****-Y	LG6AEL-840M-L****-Y	639,00
per meter	4000K	DALI	High	3240lm/27,4W	3,3	LG6AWL-840H-L****-Y	LG6AEL-840H-L****-Y	639,00

**** Your length in mm

Meterpreise für Lichtsysteme nach Maß ab Mindestlänge 2200mm | Prices per metre for customised lighting systems with a minimum length of 2200mm
 Prix au mètre pour systèmes d'éclairage sur mesure à partir d'une longueur minimale de 2200mm

... Matric G6/R6 | System 81mm Suspended

Opal Diffuser | Direct-Indirect

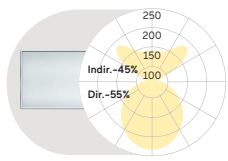

L mm	Colour Temperature	Control	Power	Lumen/Watt	Weight kg	Code Snow White	Code Silver Anodised	CHF
890	4000K	On/Off	Low	3330lm/26W	3,5	LR6OWE-840E-L890-Y	LR6OEE-840E-L890-Y	786,00
890	4000K	On/Off	Medium	4530lm/34W	3,5	LR6OWE-840M-L890-Y	LR6OEE-840M-L890-Y	786,00
890	4000K	On/Off	High	6140lm/46W	3,5	LR6OWE-840H-L890-Y	LR6OEE-840H-L890-Y	786,00
1182	4000K	On/Off	Low	4440lm/33W	4,3	LR6OWE-840E-L1182-Y	LR6OEE-840E-L1182-Y	867,00
1182	4000K	On/Off	Medium	6050lm/44W	4,3	LR6OWE-840M-L1182-Y	LR6OEE-840M-L1182-Y	867,00
1182	4000K	On/Off	High	8190lm/61W	4,3	LR6OWE-840H-L1182-Y	LR6OEE-840H-L1182-Y	867,00
1475	4000K	On/Off	Low	5550lm/40W	5,1	LR6OWE-840E-L1475-Y	LR6OEE-840E-L1475-Y	961,00
1475	4000K	On/Off	Medium	7560lm/54W	5,1	LR6OWE-840M-L1475-Y	LR6OEE-840M-L1475-Y	961,00
1475	4000K	On/Off	High	10230lm/74W	5,1	LR6OWE-840H-L1475-Y	LR6OEE-840H-L1475-Y	961,00
1765	4000K	On/Off	Low	6660lm/47W	5,8	LR6OWE-840E-L1765-Y	LR6OEE-840E-L1765-Y	1119,00
1765	4000K	On/Off	Medium	9070lm/64W	5,8	LR6OWE-840M-L1765-Y	LR6OEE-840M-L1765-Y	1119,00
1765	4000K	On/Off	High	12290lm/88W	5,8	LR6OWE-840H-L1765-Y	LR6OEE-840H-L1765-Y	1119,00
2055	4000K	On/Off	Low	7760lm/56W	6,9	LR6OWE-840E-L2055-Y	LR6OEE-840E-L2055-Y	1383,00
2055	4000K	On/Off	Medium	10580lm/76W	6,9	LR6OWE-840M-L2055-Y	LR6OEE-840M-L2055-Y	1383,00
2055	4000K	On/Off	High	14330lm/104W	6,9	LR6OWE-840H-L2055-Y	LR6OEE-840H-L2055-Y	1383,00
per meter	4000K	On/Off	Low	3780lm/26,2W	3,8	LR6OWE-840E-L****-Y	LR6OEE-840E-L****-Y	674,00
per meter	4000K	On/Off	Medium	5150lm/35,9W	3,8	LR6OWE-840M-L****-Y	LR6OEE-840M-L****-Y	674,00
per meter	4000K	On/Off	High	6990lm/49,4W	3,8	LR6OWE-840H-L****-Y	LR6OEE-840H-L****-Y	674,00
per meter	4000K	DALI	Low	3780lm/26,2W	3,8	LR6OWL-840E-L****-Y	LR6OEL-840E-L****-Y	744,00
per meter	4000K	DALI	Medium	5150lm/35,9W	3,8	LR6OWL-840M-L****-Y	LR6OEL-840M-L****-Y	744,00
per meter	4000K	DALI	High	6990lm/49,4W	3,8	LR6OWL-840H-L****-Y	LR6OEL-840H-L****-Y	744,00

Opal Diffuser | Direct

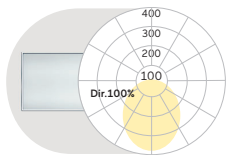

L mm	Colour Temperature	Control	Power	Lumen/Watt	Weight kg	Code Snow White	Code Silver Anodised	CHF
890	4000K	On/Off	Low	1920lm/15W	3,0	LG6OWE-840E-L890-Y	LG6OEE-840E-L890-Y	681,00
890	4000K	On/Off	Medium	2560lm/19W	3,0	LG6OWE-840M-L890-Y	LG6OEE-840M-L890-Y	681,00
890	4000K	On/Off	High	3460lm/26W	3,0	LG6OWE-840H-L890-Y	LG6OEE-840H-L890-Y	681,00
1182	4000K	On/Off	Low	2560lm/19W	3,7	LG6OWE-840E-L1182-Y	LG6OEE-840E-L1182-Y	727,00
1182	4000K	On/Off	Medium	3420lm/25W	3,7	LG6OWE-840M-L1182-Y	LG6OEE-840M-L1182-Y	727,00
1182	4000K	On/Off	High	4610lm/34W	3,7	LG6OWE-840H-L1182-Y	LG6OEE-840H-L1182-Y	727,00
1475	4000K	On/Off	Low	3200lm/23W	4,5	LG6OWE-840E-L1475-Y	LG6OEE-840E-L1475-Y	795,00
1475	4000K	On/Off	Medium	4270lm/31W	4,5	LG6OWE-840M-L1475-Y	LG6OEE-840M-L1475-Y	795,00
1475	4000K	On/Off	High	5760lm/42W	4,5	LG6OWE-840H-L1475-Y	LG6OEE-840H-L1475-Y	795,00
1765	4000K	On/Off	Low	3840lm/27W	5,2	LG6OWE-840E-L1765-Y	LG6OEE-840E-L1765-Y	882,00
1765	4000K	On/Off	Medium	5130lm/36W	5,2	LG6OWE-840M-L1765-Y	LG6OEE-840M-L1765-Y	882,00
1765	4000K	On/Off	High	6920lm/49W	5,2	LG6OWE-840H-L1765-Y	LG6OEE-840H-L1765-Y	882,00
2055	4000K	On/Off	Low	4470lm/31W	6,2	LG6OWE-840E-L2055-Y	LG6OEE-840E-L2055-Y	1092,00
2055	4000K	On/Off	Medium	5980lm/42W	6,2	LG6OWE-840M-L2055-Y	LG6OEE-840M-L2055-Y	1092,00
2055	4000K	On/Off	High	8070lm/57W	6,2	LG6OWE-840H-L2055-Y	LG6OEE-840H-L2055-Y	1092,00
per meter	4000K	On/Off	Low	2180lm/15,1W	3,3	LG6OWE-840E-L****-Y	LG6OEE-840E-L****-Y	543,00
per meter	4000K	On/Off	Medium	2920lm/20,2W	3,3	LG6OWE-840M-L****-Y	LG6OEE-840M-L****-Y	543,00
per meter	4000K	On/Off	High	3940lm/27,4W	3,3	LG6OWE-840H-L****-Y	LG6OEE-840H-L****-Y	543,00
per meter	4000K	DALI	Low	2180lm/15,1W	3,3	LG6OWL-840E-L****-Y	LG6OEL-840E-L****-Y	595,00
per meter	4000K	DALI	Medium	2920lm/20,2W	3,3	LG6OWL-840M-L****-Y	LG6OEL-840M-L****-Y	595,00
per meter	4000K	DALI	High	3940lm/27,4W	3,3	LG6OWL-840H-L****-Y	LG6OEL-840H-L****-Y	595,00

Wallwasher | Direct-Indirect

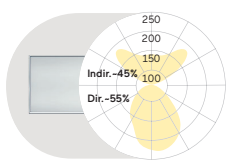

L mm	Colour Temperature	Control	Power	Lumen/Watt	Weight kg	Code Snow White	Code Silver Anodised	CHF
890	4000K	On/Off	Low	3060lm/26W	3,5	LR6JWE-840E-L890-Y	LR6JEE-840E-L890-Y	790,00
890	4000K	On/Off	Medium	4180lm/34W	3,5	LR6JWE-840M-L890-Y	LR6JEE-840M-L890-Y	790,00
890	4000K	On/Off	High	5660lm/46W	3,5	LR6JWE-840H-L890-Y	LR6JEE-840H-L890-Y	790,00
1182	4000K	On/Off	Low	4080lm/33W	4,3	LR6JWE-840E-L1182-Y	LR6JEE-840E-L1182-Y	882,00
1182	4000K	On/Off	Medium	5570lm/44W	4,3	LR6JWE-840M-L1182-Y	LR6JEE-840M-L1182-Y	882,00
1182	4000K	On/Off	High	7550lm/61W	4,3	LR6JWE-840H-L1182-Y	LR6JEE-840H-L1182-Y	882,00
1475	4000K	On/Off	Low	5100lm/40W	5,1	LR6JWE-840E-L1475-Y	LR6JEE-840E-L1475-Y	991,00
1475	4000K	On/Off	Medium	6970lm/54W	5,1	LR6JWE-840M-L1475-Y	LR6JEE-840M-L1475-Y	991,00
1475	4000K	On/Off	High	9430lm/74W	5,1	LR6JWE-840H-L1475-Y	LR6JEE-840H-L1475-Y	991,00
1765	4000K	On/Off	Low	6120lm/47W	5,8	LR6JWE-840E-L1765-Y	LR6JEE-840E-L1765-Y	1159,00
1765	4000K	On/Off	Medium	8360lm/64W	5,8	LR6JWE-840M-L1765-Y	LR6JEE-840M-L1765-Y	1159,00
1765	4000K	On/Off	High	11330lm/88W	5,8	LR6JWE-840H-L1765-Y	LR6JEE-840H-L1765-Y	1159,00
2055	4000K	On/Off	Low	7140lm/56W	6,9	LR6JWE-840E-L2055-Y	LR6JEE-840E-L2055-Y	1437,00
2055	4000K	On/Off	Medium	9750lm/76W	6,9	LR6JWE-840M-L2055-Y	LR6JEE-840M-L2055-Y	1437,00
2055	4000K	On/Off	High	13210lm/104W	6,9	LR6JWE-840H-L2055-Y	LR6JEE-840H-L2055-Y	1437,00
per meter	4000K	On/Off	Low	3480lm/26,2W	3,8	LR6JWE-840E-L****-Y	LR6JEE-840E-L****-Y	700,00
per meter	4000K	On/Off	Medium	4750lm/35,9W	3,8	LR6JWE-840M-L****-Y	LR6JEE-840M-L****-Y	700,00
per meter	4000K	On/Off	High	6450lm/49,4W	3,8	LR6JWE-840H-L****-Y	LR6JEE-840H-L****-Y	700,00
per meter	4000K	DALI	Low	3480lm/26,2W	3,8	LR6JWL-840E-L****-Y	LR6JEL-840E-L****-Y	770,00
per meter	4000K	DALI	Medium	4750lm/35,9W	3,8	LR6JWL-840M-L****-Y	LR6JEL-840M-L****-Y	770,00
per meter	4000K	DALI	High	6450lm/49,4W	3,8	LR6JWL-840H-L****-Y	LR6JEL-840H-L****-Y	770,00

**** Your length in mm

Meterpreise für Lichtsysteme nach Maß ab Mindestlänge 2200mm | Prices per metre for customised lighting systems with a minimum length of 2200mm
 Prix au mètre pour systèmes d'éclairage sur mesure à partir d'une longueur minimale de 2200mm

Wallwasher | Direct

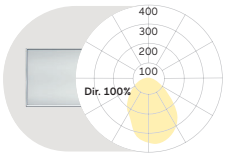

L mm	Colour Temperature	Control	Power	Lumen/Watt	Weight kg	Code Snow White	Code Silver Anodised	CHF
890	4000K	On/Off	Low	1650lm/15W	3,0	LG6JWE-840E-L890-Y	LG6JEE-840E-L890-Y	688,00
890	4000K	On/Off	Medium	2210lm/19W	3,0	LG6JWE-840M-L890-Y	LG6JEE-840M-L890-Y	688,00
890	4000K	On/Off	High	2980lm/26W	3,0	LG6JWE-840H-L890-Y	LG6JEE-840H-L890-Y	688,00
1182	4000K	On/Off	Low	2200lm/19W	3,7	LG6JWE-840E-L1182-Y	LG6JEE-840E-L1182-Y	749,00
1182	4000K	On/Off	Medium	2940lm/25W	3,7	LG6JWE-840M-L1182-Y	LG6JEE-840M-L1182-Y	749,00
1182	4000K	On/Off	High	3970lm/34W	3,7	LG6JWE-840H-L1182-Y	LG6JEE-840H-L1182-Y	749,00
1475	4000K	On/Off	Low	2750lm/23W	4,5	LG6JWE-840E-L1475-Y	LG6JEE-840E-L1475-Y	832,00
1475	4000K	On/Off	Medium	3680lm/31W	4,5	LG6JWE-840M-L1475-Y	LG6JEE-840M-L1475-Y	832,00
1475	4000K	On/Off	High	4960lm/42W	4,5	LG6JWE-840H-L1475-Y	LG6JEE-840H-L1475-Y	832,00
1765	4000K	On/Off	Low	3300lm/27W	5,2	LG6JWE-840E-L1765-Y	LG6JEE-840E-L1765-Y	931,00
1765	4000K	On/Off	Medium	4420lm/36W	5,2	LG6JWE-840M-L1765-Y	LG6JEE-840M-L1765-Y	931,00
1765	4000K	On/Off	High	5960lm/49W	5,2	LG6JWE-840H-L1765-Y	LG6JEE-840H-L1765-Y	931,00
2055	4000K	On/Off	Low	3850lm/31W	6,2	LG6JWE-840E-L2055-Y	LG6JEE-840E-L2055-Y	1159,00
2055	4000K	On/Off	Medium	5150lm/42W	6,2	LG6JWE-840M-L2055-Y	LG6JEE-840M-L2055-Y	1159,00
2055	4000K	On/Off	High	6950lm/57W	6,2	LG6JWE-840H-L2055-Y	LG6JEE-840H-L2055-Y	1159,00
per meter	4000K	On/Off	Low	1880lm/15,1W	3,3	LG6JWE-840E-L****-Y	LG6JEE-840E-L****-Y	569,00
per meter	4000K	On/Off	Medium	2520lm/20,2W	3,3	LG6JWE-840M-L****-Y	LG6JEE-840M-L****-Y	569,00
per meter	4000K	On/Off	High	3400lm/27,4W	3,3	LG6JWE-840H-L****-Y	LG6JEE-840H-L****-Y	569,00
per meter	4000K	DALI	Low	1880lm/15,1W	3,3	LG6JWL-840E-L****-Y	LG6JEL-840E-L****-Y	622,00
per meter	4000K	DALI	Medium	2520lm/20,2W	3,3	LG6JWL-840M-L****-Y	LG6JEL-840M-L****-Y	622,00
per meter	4000K	DALI	High	3400lm/27,4W	3,3	LG6JWL-840H-L****-Y	LG6JEL-840H-L****-Y	622,00

**** Your length in mm

Meterpreise für Lichtsysteme nach Maß ab Mindestlänge 2200mm | Prices per metre for customised lighting systems with a minimum length of 2200mm
 Prix au mètre pour systèmes d'éclairage sur mesure à partir d'une longueur minimale de 2200mm



90° Corner
Opal/Microprismatic

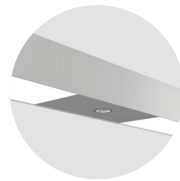

Midpin Downlight XD
770lm/10W/Ø40mm

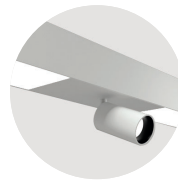

Midpin Spotlight XM
770lm/10W/Ø40mm

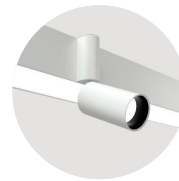

Midpin Spotlight XP
770lm/10W/Ø40mm



Multisensor

Surcharges

Surface Finish

Surface Finish	CHF
W: Snow White	✓
V: Ivory White	✓
E: Silver Anodised	✓
U: Urban Graphite	✓
B: Jet Black	✓
H: Anodic Champagne	+10%
K: Satin Copper	+15%
R: Special RAL/NCS Colours	🔗

Control Gear

Control Gear	CHF L890-L1765	CHF L2055
E: On/Off	✓	✓
L: DALI	+86,00	+172,00
H: Touch-Dim	+86,00	+172,00
C: Casambi*	+261,00	+261,00
6: DALI DT6 for TW	+172,00	+343,00
8: DALI DT8 for TW	+172,00	+343,00

*Only in combination with DALI. Please add to dimming price.

Colour Rendering

Colour Rendering	CHF
8: CRI>80	✓
9: CRI>90	+5%
F: Full Spectrum	+15%

Colour Temperature

Colour Temperature	CHF
22: 2200K	+5%
27: 2700K	+5%
30: 3000K	✓
35: 3500K	+5%
40: 4000K	✓
65: 6500K	+5%
TW: Tunable White 2700-6500K*	+30%

*Only in combination with DT6, DT8 or Casambi control. Please add additional control price.

Additional Options

Additional Options	CHF
90° Corner	🔗
Midpin Downlight XD	+363,00
Midpin Spotlight XM	+363,00
Midpin Spotlight XP	+433,00
Multisensor [L1182-L2055]	+261,00
Emergency Module [DALI, Autotest, incl. 3H Battery] [L1182-L2055]	+366,00

✓ standard / no extra charge 🔗 on request ✗ not available

Matric Square GX/RX | System 40 mm Suspended

catalogue page 322

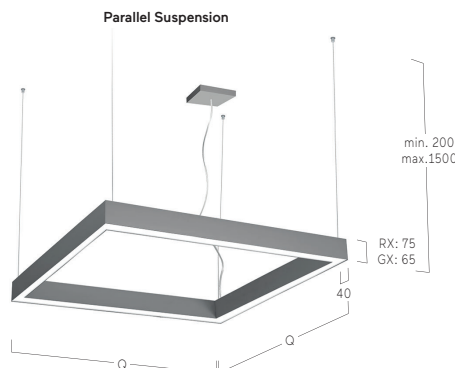

... Matric Square GX/RX | System 40mm Suspended

Microprismatic | Direct-Indirect

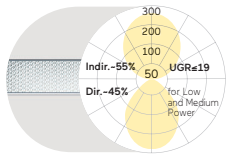

Q mm	Colour Temperature	Control	Power	Lumen/Watt	Weight kg	Code Snow White	Code Radiant Silver	CHF
640	4000K	On/Off	Low	5210lm/48W	7,0	LRXAW E-840E-Q640-K	LRXASE-840E-Q640-K	3133,00
640	4000K	On/Off	Medium	7120lm/63W	7,0	LRXAW E-840M-Q640-K	LRXASE-840M-Q640-K	3133,00
640	4000K	On/Off	High	9360lm/83W	7,0	LRXAW E-840H-Q640-K	LRXASE-840H-Q640-K	3133,00
930	4000K	On/Off	Low	8100lm/69W	10,0	LRXAW E-840E-Q930-K	LRXASE-840E-Q930-K	3465,00
930	4000K	On/Off	Medium	11060lm/93W	10,0	LRXAW E-840M-Q930-K	LRXASE-840M-Q930-K	3465,00
930	4000K	On/Off	High	14530lm/124W	10,0	LRXAW E-840H-Q930-K	LRXASE-840H-Q930-K	3465,00
1220	4000K	On/Off	Low	10980lm/99W	14,0	LRXAW E-840E-Q1220-K	LRXASE-840E-Q1220-K	3938,00
1220	4000K	On/Off	Medium	15010lm/133W	14,0	LRXAW E-840M-Q1220-K	LRXASE-840M-Q1220-K	3938,00
1220	4000K	On/Off	High	19700lm/174W	14,0	LRXAW E-840H-Q1220-K	LRXASE-840H-Q1220-K	3938,00
1510	4000K	On/Off	Low	13860lm/120W	17,0	LRXAW E-840E-Q1510-K	LRXASE-840E-Q1510-K	4428,00
1510	4000K	On/Off	Medium	18940lm/162W	17,0	LRXAW E-840M-Q1510-K	LRXASE-840M-Q1510-K	4428,00
1510	4000K	On/Off	High	24870lm/214W	17,0	LRXAW E-840H-Q1510-K	LRXASE-840H-Q1510-K	4428,00

Microprismatic | Direct

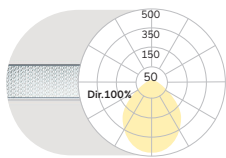

Q mm	Colour Temperature	Control	Power	Lumen/Watt	Weight kg	Code Snow White	Code Radiant Silver	CHF
640	4000K	On/Off	Low	2450lm/24W	5,5	LGXAW E-840E-Q640-K	LGXASE-840E-Q640-K	2783,00
640	4000K	On/Off	High	4400lm/42W	5,5	LGXAW E-840H-Q640-K	LGXASE-840H-Q640-K	2783,00
930	4000K	On/Off	Low	3680lm/34W	7,5	LGXAW E-840E-Q930-K	LGXASE-840E-Q930-K	2940,00
930	4000K	On/Off	High	6600lm/60W	7,5	LGXAW E-840H-Q930-K	LGXASE-840H-Q930-K	2940,00
1220	4000K	On/Off	Low	4910lm/48W	10,0	LGXAW E-840E-Q1220-K	LGXASE-840E-Q1220-K	3238,00
1220	4000K	On/Off	High	8790lm/83W	10,0	LGXAW E-840H-Q1220-K	LGXASE-840H-Q1220-K	3238,00
1510	4000K	On/Off	Low	6130lm/57W	12,0	LGXAW E-840E-Q1510-K	LGXASE-840E-Q1510-K	3553,00
1510	4000K	On/Off	High	10990lm/101W	12,0	LGXAW E-840H-Q1510-K	LGXASE-840H-Q1510-K	3553,00

Opal Diffuser | Direct-Indirect

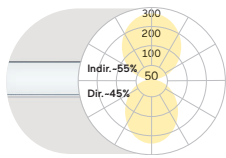

Q mm	Colour Temperature	Control	Power	Lumen/Watt	Weight kg	Code Snow White	Code Radiant Silver	CHF
640	4000K	On/Off	Medium	7340lm/63W	7,0	LRXOW E-840M-Q640-K	LRXOSE-840M-Q640-K	3063,00
640	4000K	On/Off	High	9660lm/83W	7,0	LRXOW E-840H-Q640-K	LRXOSE-840H-Q640-K	3063,00
930	4000K	On/Off	Medium	11390lm/93W	10,0	LRXOW E-840M-Q930-K	LRXOSE-840M-Q930-K	3378,00
930	4000K	On/Off	High	14980lm/124W	10,0	LRXOW E-840H-Q930-K	LRXOSE-840H-Q930-K	3378,00
1220	4000K	On/Off	Medium	15450lm/133W	14,0	LRXOW E-840M-Q1220-K	LRXOSE-840M-Q1220-K	3798,00
1220	4000K	On/Off	High	20310lm/174W	14,0	LRXOW E-840H-Q1220-K	LRXOSE-840H-Q1220-K	3798,00
1510	4000K	On/Off	Medium	19500lm/162W	17,0	LRXOW E-840M-Q1510-K	LRXOSE-840M-Q1510-K	4253,00
1510	4000K	On/Off	High	25640lm/214W	17,0	LRXOW E-840H-Q1510-K	LRXOSE-840H-Q1510-K	4253,00

Opal Diffuser | Direct

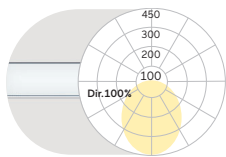

Q mm	Colour Temperature	Control	Power	Lumen/Watt	Weight kg	Code Snow White	Code Radiant Silver	CHF
640	4000K	On/Off	Medium	3460lm/31W	5,5	LGXOW E-840M-Q640-K	LGXOSE-840M-Q640-K	2713,00
640	4000K	On/Off	High	4700lm/42W	5,5	LGXOW E-840H-Q640-K	LGXOSE-840H-Q640-K	2713,00
930	4000K	On/Off	Medium	5190lm/44W	7,5	LGXOW E-840M-Q930-K	LGXOSE-840M-Q930-K	2835,00
930	4000K	On/Off	High	7050lm/60W	7,5	LGXOW E-840H-Q930-K	LGXOSE-840H-Q930-K	2835,00
1220	4000K	On/Off	Medium	6930lm/62W	10,0	LGXOW E-840M-Q1220-K	LGXOSE-840M-Q1220-K	3098,00
1220	4000K	On/Off	High	9400lm/83W	10,0	LGXOW E-840H-Q1220-K	LGXOSE-840H-Q1220-K	3098,00
1510	4000K	On/Off	Medium	8650lm/74W	12,0	LGXOW E-840M-Q1510-K	LGXOSE-840M-Q1510-K	3378,00
1510	4000K	On/Off	High	11750lm/101W	12,0	LGXOW E-840H-Q1510-K	LGXOSE-840H-Q1510-K	3378,00

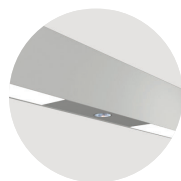

Midpin Downlight XD
310lm/5W/Ø21mm



Midpin Spotlight XM
770lm/10W/Ø40mm



Midpin Spotlight XP
770lm/10W/Ø40mm

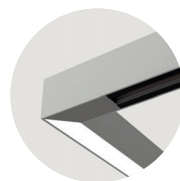

48V Track



Multisensor

Surcharges

Surface	CHF	Control Gear	CHF	CHF	Colour Rendering	CHF	Colour Temperature	CHF	Additional Options	CHF
W: Snow White	✓	E: On/Off	✓	✓	8: CRI>80	✓	22: 2200K	+5%	Midpin Downlight XD	+363,00
S: Radiant Silver	✓	L: DALI	+168,00	+336,00	9: CRI>90	+5%	27: 2700K	+5%	Midpin Spotlight XM	+363,00
U: Urban Graphite	✓	H: Touch-Dim	+168,00	+336,00	F: Full Spectrum	+15%	30: 3000K	✓	Midpin Spotlight XP	+433,00
B: Jet Black	✓	C: Casambi*	+261,00	+522,00			35: 3500K	+5%	Multisensor	+261,00
H: Anodic Champagne	+10%	6: DALI DT6 for TW	+336,00	+672,00			40: 4000K	✓	Emergency Module [DALI, Autotest, incl. 3H Battery]	+366,00
K: Satin Copper	+15%	8: DALI DT8 for TW	+336,00	+672,00			65: 6500K	+5%	48V Track	ⓘ
R: Special RAL/NCS Colours	ⓘ						TW: Tunable White 2700-6500K*	+30%		

*Only in combination with DALI. Please add to dimming price.

*Only in combination with DT6, DT8 or Casambi control. Please add additional control price.

✓ standard / no extra charge ⓘ on request ✗ not available

Matric Square Acoustic GX/RX | System 40mm Suspended

catalogue page 326

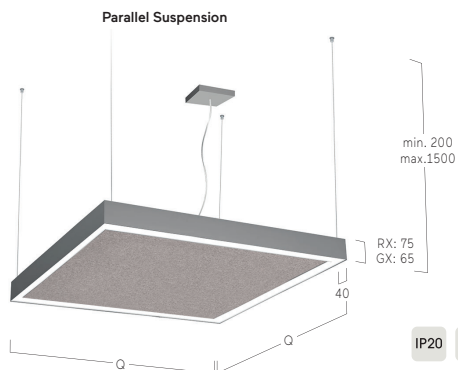

Microprismatic | Direct-Indirect

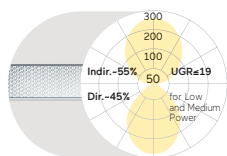

Q mm	Colour Temperature	Control	Power	Lumen/Watt	Weight kg	Code Snow White	Code Radiant Silver	CHF
640	4000K	On/Off	Low	5210lm/48W	13,0	LRXAW E-840E-Q640-K-AW	LRXAS E-840E-Q640-K-AW	3658,00
640	4000K	On/Off	Medium	7120lm/63W	13,0	LRXAW E-840M-Q640-K-AW	LRXAS E-840M-Q640-K-AW	3658,00
640	4000K	On/Off	High	9360lm/83W	13,0	LRXAW E-840H-Q640-K-AW	LRXAS E-840H-Q640-K-AW	3658,00
930	4000K	On/Off	Low	8100lm/69W	17,0	LRXAW E-840E-Q930-K-AW	LRXAS E-840E-Q930-K-AW	4165,00
930	4000K	On/Off	Medium	11060lm/93W	17,0	LRXAW E-840M-Q930-K-AW	LRXAS E-840M-Q930-K-AW	4165,00
930	4000K	On/Off	High	14530lm/124W	17,0	LRXAW E-840H-Q930-K-AW	LRXAS E-840H-Q930-K-AW	4165,00
1220	4000K	On/Off	Low	10980lm/99W	23,0	LRXAW E-840E-Q1220-K-AW	LRXAS E-840E-Q1220-K-AW	4813,00
1220	4000K	On/Off	Medium	15010lm/133W	23,0	LRXAW E-840M-Q1220-K-AW	LRXAS E-840M-Q1220-K-AW	4813,00
1220	4000K	On/Off	High	19700lm/174W	23,0	LRXAW E-840H-Q1220-K-AW	LRXAS E-840H-Q1220-K-AW	4813,00
1510	4000K	On/Off	Low	13860lm/120W	31,0	LRXAW E-840E-Q1510-K-AW	LRXAS E-840E-Q1510-K-AW	5478,00
1510	4000K	On/Off	Medium	18940lm/162W	31,0	LRXAW E-840M-Q1510-K-AW	LRXAS E-840M-Q1510-K-AW	5478,00
1510	4000K	On/Off	High	24870lm/214W	31,0	LRXAW E-840H-Q1510-K-AW	LRXAS E-840H-Q1510-K-AW	5478,00

Microprismatic | Direct

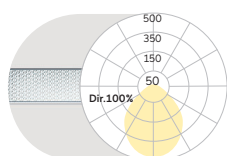

Q mm	Colour Temperature	Control	Power	Lumen/Watt	Weight kg	Code Snow White	Code Radiant Silver	CHF
640	4000K	On/Off	Low	2450lm/24W	12,0	LGXAW E-840E-Q640-K-AW	LGXAS E-840E-Q640-K-AW	3308,00
640	4000K	On/Off	High	4400lm/42W	12,0	LGXAW E-840H-Q640-K-AW	LGXAS E-840H-Q640-K-AW	3308,00
930	4000K	On/Off	Low	3680lm/34W	17,0	LGXAW E-840E-Q930-K-AW	LGXAS E-840E-Q930-K-AW	3640,00
930	4000K	On/Off	High	6600lm/60W	17,0	LGXAW E-840H-Q930-K-AW	LGXAS E-840H-Q930-K-AW	3640,00
1220	4000K	On/Off	Low	4910lm/48W	21,0	LGXAW E-840E-Q1220-K-AW	LGXAS E-840E-Q1220-K-AW	4113,00
1220	4000K	On/Off	High	8790lm/83W	21,0	LGXAW E-840H-Q1220-K-AW	LGXAS E-840H-Q1220-K-AW	4113,00
1510	4000K	On/Off	Low	6130lm/57W	29,0	LGXAW E-840E-Q1510-K-AW	LGXAS E-840E-Q1510-K-AW	5233,00
1510	4000K	On/Off	High	10990lm/101W	29,0	LGXAW E-840H-Q1510-K-AW	LGXAS E-840H-Q1510-K-AW	5233,00

Opal Diffuser | Direct-Indirect

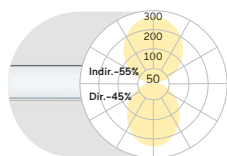

Q mm	Colour Temperature	Control	Power	Lumen/Watt	Weight kg	Code Snow White	Code Radiant Silver	CHF
640	4000K	On/Off	Medium	7340lm/63W	13,0	LRXOW E-840M-Q640-K-AW	LRXOSE-840M-Q640-K-AW	3588,00
640	4000K	On/Off	High	9660lm/83W	13,0	LRXOW E-840H-Q640-K-AW	LRXOSE-840H-Q640-K-AW	3588,00
930	4000K	On/Off	Medium	11390lm/93W	17,0	LRXOW E-840M-Q930-K-AW	LRXOSE-840M-Q930-K-AW	4060,00
930	4000K	On/Off	High	14980lm/124W	17,0	LRXOW E-840H-Q930-K-AW	LRXOSE-840H-Q930-K-AW	4060,00
1220	4000K	On/Off	Medium	15450lm/133W	23,0	LRXOW E-840M-Q1220-K-AW	LRXOSE-840M-Q1220-K-AW	4673,00
1220	4000K	On/Off	High	20310lm/174W	23,0	LRXOW E-840H-Q1220-K-AW	LRXOSE-840H-Q1220-K-AW	4673,00
1510	4000K	On/Off	Medium	19500lm/162W	31,0	LRXOW E-840M-Q1510-K-AW	LRXOSE-840M-Q1510-K-AW	5303,00
1510	4000K	On/Off	High	25640lm/214W	31,0	LRXOW E-840H-Q1510-K-AW	LRXOSE-840H-Q1510-K-AW	5303,00

Opal Diffuser | Direct

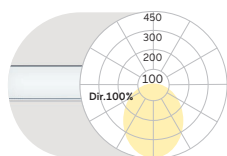

Q mm	Colour Temperature	Control	Power	Lumen/Watt	Weight kg	Code Snow White	Code Radiant Silver	CHF
640	4000K	On/Off	Medium	3460lm/31W	12,0	LGXOW E-840M-Q640-K-AW	LGXOSE-840M-Q640-K-AW	3238,00
640	4000K	On/Off	High	4700lm/42W	12,0	LGXOW E-840H-Q640-K-AW	LGXOSE-840H-Q640-K-AW	3238,00
930	4000K	On/Off	Medium	5190lm/44W	17,0	LGXOW E-840M-Q930-K-AW	LGXOSE-840M-Q930-K-AW	3535,00
930	4000K	On/Off	High	7050lm/60W	17,0	LGXOW E-840H-Q930-K-AW	LGXOSE-840H-Q930-K-AW	3535,00
1220	4000K	On/Off	Medium	6930lm/62W	21,0	LGXOW E-840M-Q1220-K-AW	LGXOSE-840M-Q1220-K-AW	3973,00
1220	4000K	On/Off	High	9400lm/83W	21,0	LGXOW E-840H-Q1220-K-AW	LGXOSE-840H-Q1220-K-AW	3973,00
1510	4000K	On/Off	Medium	8650lm/74W	29,0	LGXOW E-840M-Q1510-K-AW	LGXOSE-840M-Q1510-K-AW	5058,00
1510	4000K	On/Off	High	11750lm/101W	29,0	LGXOW E-840H-Q1510-K-AW	LGXOSE-840H-Q1510-K-AW	5058,00

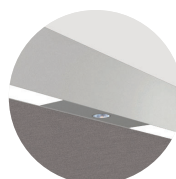

Midpin Downlight XD
310lm/5W/Ø21mm

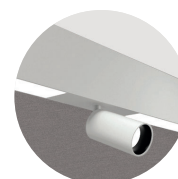

Midpin Spotlight XM
770lm/10W/Ø40mm

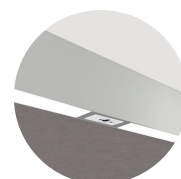

Multisensor

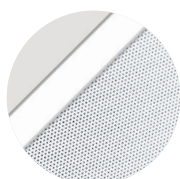

AW Micro Perforated

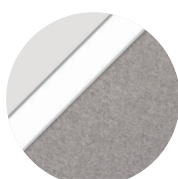

BW: Beige Wool

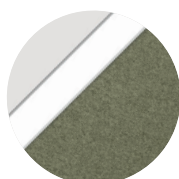

ZW: Green Wool

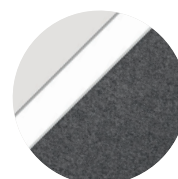

GW: Graphite Wool

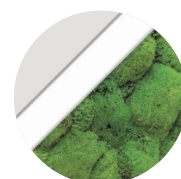

AM Green Moss

Surcharges										
Surface	CHF	Control Gear	CHF	CHF	Colour Rendering	CHF	Colour Temperature	CHF	Acoustic Absorber	CHF
W: Snow White	✓	E: On/Off	Q640-Q930	Q1220-Q1510	8: CRI>80	✓	22: 2200K	+5%	AW: Micro Perforated	✓
S: Radiant Silver	✓	L: DALI	+168,00	+336,00	9: CRI>90	+5%	27: 2700K	+5%	BW: Beige Wool	+5%
U: Urban Graphite	✓	H: Touch-Dim	+168,00	+336,00	F: Full Spectrum	+15%	30: 3000K	✓	ZW: Green Wool	+5%
B: Jet Black	✓	C: Casambi*	+261,00	+522,00			35: 3500K	+5%	GW: Graphite Wool	+5%
H: Anodic Champagne	+10%	6: DALI DT6 for TW	+336,00	+672,00			40: 4000K	✓	AM: Green Moss	⚠
K: Satin Copper	+15%	8: DALI DT8 for TW	+336,00	+672,00			65: 6500K	+5%		
R: Special RAL/NCS Colours	⚠						TW: Tunable White 2700-6500K*	+30%		
		*Only in combination with DALI. Please add to dimming price.							Additional Options	CHF
									Midpin Downlight XD	+363,00
									Midpin Spotlight XM	+363,00
									Multisensor	+261,00
									Emergency Module [DALI, Autotest, incl. 3H Battery]	+366,00
✓ standard / no extra charge ⚠ on request ✗ not available										

Vision Gen. 4 G4/P4 | Suspended

catalogue page 328

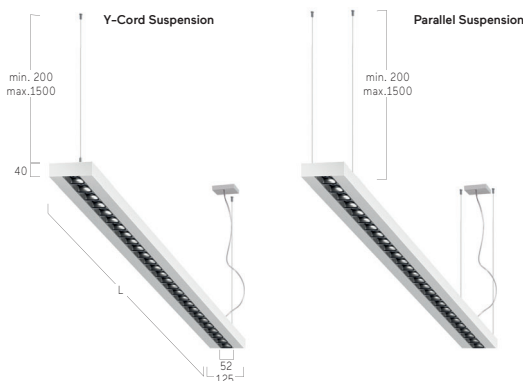
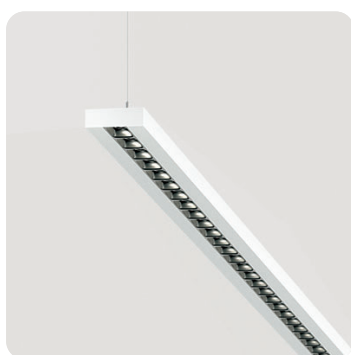

Lens Louvre | Direct-Indirect

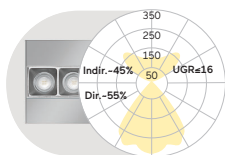

L mm	Colour Temperature	Control	Power	Lumen/Watt	Weight kg	Code Snow White/Jet Black	Code Silver Anodised/Jet Black	CHF
1004	4000K	On/Off	Medium	4470lm/34W	3,9	VP4LWE-840M-L1004-YB*	VP4LEE-840M-L1004-YB*	727,00
1004	4000K	On/Off	High	6270lm/48W	3,9	VP4LWE-840H-L1004-YB*	VP4LEE-840H-L1004-YB*	727,00
1254	4000K	On/Off	Medium	5750lm/42W	4,6	VP4LWE-840M-L1254-YB*	VP4LEE-840M-L1254-YB*	823,00
1254	4000K	On/Off	High	8080lm/61W	4,6	VP4LWE-840H-L1254-YB*	VP4LEE-840H-L1254-YB*	823,00
1504	4000K	On/Off	Medium	7040lm/50W	5,3	VP4LWE-840M-L1504-YB*	VP4LEE-840M-L1504-YB*	937,00
1504	4000K	On/Off	High	9850lm/73W	5,3	VP4LWE-840H-L1504-YB*	VP4LEE-840H-L1504-YB*	937,00
1754	4000K	On/Off	Medium	8310lm/58W	6,0	VP4LWE-840M-L1754-YB*	VP4LEE-840M-L1754-YB*	1077,00
1754	4000K	On/Off	High	11650lm/85W	6,0	VP4LWE-840H-L1754-YB*	VP4LEE-840H-L1754-YB*	1077,00
2004	4000K	On/Off	Medium	9600lm/69W	6,9	VP4LWE-840M-L2004-YB*	VP4LEE-840M-L2004-YB*	1252,00
2004	4000K	On/Off	High	13440lm/100W	6,9	VP4LWE-840H-L2004-YB*	VP4LEE-840H-L2004-YB*	1252,00
per meter	4000K	On/Off	Medium	4750lm/33,1W	3,9	VP4LWE-840M-L****-YB*	VP4LEE-840M-L****-YB*	639,00
per meter	4000K	On/Off	High	6670lm/48,6W	3,9	VP4LWE-840H-L****-YB*	VP4LEE-840H-L****-YB*	639,00
per meter	4000K	DALI	Medium	4750lm/33,1W	3,9	VP4LWL-840M-L****-YB*	VP4LEL-840M-L****-YB*	709,00
per meter	4000K	DALI	High	6670lm/48,6W	3,9	VP4LWL-840H-L****-YB*	VP4LEL-840H-L****-YB*	709,00

Microprismatic | Direct-Indirect

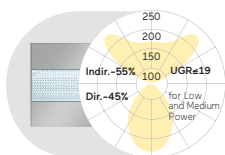

L mm	Colour Temperature	Control	Power	Lumen/Watt	Weight kg	Code Snow White	Code Silver Anodised	CHF
890	4000K	On/Off	Low	2640lm/23W	2,7	VP4AWE-840E-L890-Y	VP4AEE-840E-L890-Y	700,00
890	4000K	On/Off	Medium	3630lm/31W	2,7	VP4AWE-840M-L890-Y	VP4AEE-840M-L890-Y	700,00
890	4000K	On/Off	High	5030lm/43W	2,7	VP4AWE-840H-L890-Y	VP4AEE-840H-L890-Y	700,00
1182	4000K	On/Off	Low	3520lm/29W	3,2	VP4AWE-840E-L1182-Y	VP4AEE-840E-L1182-Y	779,00
1182	4000K	On/Off	Medium	4840lm/40W	3,2	VP4AWE-840M-L1182-Y	VP4AEE-840M-L1182-Y	779,00
1182	4000K	On/Off	High	6710lm/56W	3,2	VP4AWE-840H-L1182-Y	VP4AEE-840H-L1182-Y	779,00
1475	4000K	On/Off	Low	4400lm/35W	3,7	VP4AWE-840E-L1475-Y	VP4AEE-840E-L1475-Y	875,00
1475	4000K	On/Off	Medium	6060lm/48W	3,7	VP4AWE-840M-L1475-Y	VP4AEE-840M-L1475-Y	875,00
1475	4000K	On/Off	High	8390lm/69W	3,7	VP4AWE-840H-L1475-Y	VP4AEE-840H-L1475-Y	875,00
1765	4000K	On/Off	Low	5270lm/41W	4,2	VP4AWE-840E-L1765-Y	VP4AEE-840E-L1765-Y	998,00
1765	4000K	On/Off	Medium	7260lm/57W	4,2	VP4AWE-840M-L1765-Y	VP4AEE-840M-L1765-Y	998,00
1765	4000K	On/Off	High	10070lm/82W	4,2	VP4AWE-840H-L1765-Y	VP4AEE-840H-L1765-Y	998,00
2055	4000K	On/Off	Low	6150lm/52W	5,0	VP4AWE-840E-L2055-Y	VP4AEE-840E-L2055-Y	1155,00
2055	4000K	On/Off	Medium	8470lm/71W	5,0	VP4AWE-840M-L2055-Y	VP4AEE-840M-L2055-Y	1155,00
2055	4000K	On/Off	High	11750lm/99W	5,0	VP4AWE-840H-L2055-Y	VP4AEE-840H-L2055-Y	1155,00
per meter	4000K	On/Off	Low	2990lm/23,4W	3,0	VP4AWE-840E-L****-Y	VP4AEE-840E-L****-Y	595,00
per meter	4000K	On/Off	Medium	4120lm/32,3W	3,0	VP4AWE-840M-L****-Y	VP4AEE-840M-L****-Y	595,00
per meter	4000K	On/Off	High	5710lm/46,3W	3,0	VP4AWE-840H-L****-Y	VP4AEE-840H-L****-Y	595,00
per meter	4000K	DALI	Low	2990lm/23,4W	3,0	VP4AWL-840E-L****-Y	VP4AEL-840E-L****-Y	665,00
per meter	4000K	DALI	Medium	4120lm/32,3W	3,0	VP4AWL-840M-L****-Y	VP4AEL-840M-L****-Y	665,00
per meter	4000K	DALI	High	5710lm/46,3W	3,0	VP4AWL-840H-L****-Y	VP4AEL-840H-L****-Y	665,00

**** Your length in mm

Meterpreise für Lichtsysteme nach Maß ab Mindestlänge 2200mm | Prices per metre for customised lighting systems with a minimum length of 2200mm
 Prix au mètre pour systèmes d'éclairage sur mesure à partir d'une longueur minimale de 2200mm

Opal Diffuser | Direct-Indirect

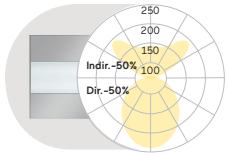

L mm	Colour Temperature	Control	Power	Lumen/Watt	Weight kg	Code Snow White	Code Silver Anodised	CHF
890	4000K	On/Off	Low	2760lm/23W	2,7	VP4OWE-840E-L890-Y	VP4OEE-840E-L890-Y	683,00
890	4000K	On/Off	Medium	3790lm/31W	2,7	VP4OWE-840M-L890-Y	VP4OEE-840M-L890-Y	683,00
890	4000K	On/Off	High	5260lm/43W	2,7	VP4OWE-840H-L890-Y	VP4OEE-840H-L890-Y	683,00
1182	4000K	On/Off	Low	3670lm/29W	3,2	VP4OWE-840E-L1182-Y	VP4OEE-840E-L1182-Y	744,00
1182	4000K	On/Off	Medium	5060lm/40W	3,2	VP4OWE-840M-L1182-Y	VP4OEE-840M-L1182-Y	744,00
1182	4000K	On/Off	High	7020lm/56W	3,2	VP4OWE-840H-L1182-Y	VP4OEE-840H-L1182-Y	744,00
1475	4000K	On/Off	Low	4590lm/35W	3,7	VP4OWE-840E-L1475-Y	VP4OEE-840E-L1475-Y	832,00
1475	4000K	On/Off	Medium	6320lm/48W	3,7	VP4OWE-840M-L1475-Y	VP4OEE-840M-L1475-Y	832,00
1475	4000K	On/Off	High	8770lm/69W	3,7	VP4OWE-840H-L1475-Y	VP4OEE-840H-L1475-Y	832,00
1765	4000K	On/Off	Low	5510lm/41W	4,2	VP4OWE-840E-L1765-Y	VP4OEE-840E-L1765-Y	945,00
1765	4000K	On/Off	Medium	7580lm/57W	4,2	VP4OWE-840M-L1765-Y	VP4OEE-840M-L1765-Y	945,00
1765	4000K	On/Off	High	10530lm/82W	4,2	VP4OWE-840H-L1765-Y	VP4OEE-840H-L1765-Y	945,00
2055	4000K	On/Off	Low	6430lm/52W	5,0	VP4OWE-840E-L2055-Y	VP4OEE-840E-L2055-Y	1085,00
2055	4000K	On/Off	Medium	8850lm/71W	5,0	VP4OWE-840M-L2055-Y	VP4OEE-840M-L2055-Y	1085,00
2055	4000K	On/Off	High	12280lm/99W	5,0	VP4OWE-840H-L2055-Y	VP4OEE-840H-L2055-Y	1085,00
per meter	4000K	On/Off	Low	3130lm/23,4W	3,0	VP4OWE-840E-L****-Y	VP4OEE-840E-L****-Y	569,00
per meter	4000K	On/Off	Medium	4300lm/32,3W	3,0	VP4OWE-840M-L****-Y	VP4OEE-840M-L****-Y	569,00
per meter	4000K	On/Off	High	5970lm/46,3W	3,0	VP4OWE-840H-L****-Y	VP4OEE-840H-L****-Y	569,00
per meter	4000K	DALI	Low	3130lm/23,4W	3,0	VP4OWL-840E-L****-Y	VP4OEL-840E-L****-Y	639,00
per meter	4000K	DALI	Medium	4300lm/32,3W	3,0	VP4OWL-840M-L****-Y	VP4OEL-840M-L****-Y	639,00
per meter	4000K	DALI	High	5970lm/46,3W	3,0	VP4OWL-840H-L****-Y	VP4OEL-840H-L****-Y	639,00

Wallwasher | Direct-Indirect

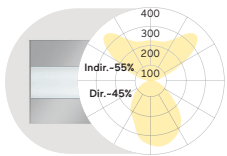

L mm	Colour Temperature	Control	Power	Lumen/Watt	Weight kg	Code Snow White	Code Silver Anodised	CHF
890	4000K	On/Off	Medium	3470lm/31W	2,7	VP4JWE-840M-L890-Y	VP4JEE-840M-L890-Y	700,00
890	4000K	On/Off	High	4810lm/43W	2,7	VP4JWE-840H-L890-Y	VP4JEE-840H-L890-Y	700,00
1182	4000K	On/Off	Medium	4630lm/40W	3,2	VP4JWE-840M-L1182-Y	VP4JEE-840M-L1182-Y	779,00
1182	4000K	On/Off	High	6420lm/56W	3,2	VP4JWE-840H-L1182-Y	VP4JEE-840H-L1182-Y	779,00
1475	4000K	On/Off	Medium	5790lm/48W	3,7	VP4JWE-840M-L1475-Y	VP4JEE-840M-L1475-Y	875,00
1475	4000K	On/Off	High	8020lm/69W	3,7	VP4JWE-840H-L1475-Y	VP4JEE-840H-L1475-Y	875,00
1765	4000K	On/Off	Medium	6940lm/57W	4,2	VP4JWE-840M-L1765-Y	VP4JEE-840M-L1765-Y	998,00
1765	4000K	On/Off	High	9620lm/82W	4,2	VP4JWE-840H-L1765-Y	VP4JEE-840H-L1765-Y	998,00
2055	4000K	On/Off	Medium	8100lm/71W	5,0	VP4JWE-840M-L2055-Y	VP4JEE-840M-L2055-Y	1155,00
2055	4000K	On/Off	High	11220lm/99W	5,0	VP4JWE-840H-L2055-Y	VP4JEE-840H-L2055-Y	1155,00
per meter	4000K	On/Off	Medium	3940lm/32,3W	3,0	VP4JWE-840M-L****-Y	VP4JEE-840M-L****-Y	578,00
per meter	4000K	On/Off	High	5460lm/46,3W	3,0	VP4JWE-840H-L****-Y	VP4JEE-840H-L****-Y	578,00
per meter	4000K	DALI	Medium	3940lm/32,3W	3,0	VP4JWL-840M-L****-Y	VP4JEL-840M-L****-Y	648,00
per meter	4000K	DALI	High	5460lm/46,3W	3,0	VP4JWL-840H-L****-Y	VP4JEL-840H-L****-Y	648,00

Lens Louvre | Direct

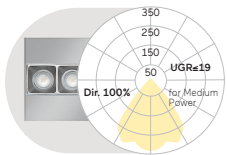

L mm	Colour Temperature	Control	Power	Lumen/Watt	Weight kg	Code Snow White/Jet Black	Code Silver Anodised/Jet Black	CHF
1004	4000K	On/Off	Medium	2500lm/19W	3,6	VG4LWE-840M-L1004-YB*	VG4LEE-840M-L1004-YB*	657,00
1004	4000K	On/Off	High	3590lm/28W	3,6	VG4LWE-840H-L1004-YB*	VG4LEE-840H-L1004-YB*	657,00
1254	4000K	On/Off	Medium	3120lm/23W	4,3	VG4LWE-840M-L1254-YB*	VG4LEE-840M-L1254-YB*	718,00
1254	4000K	On/Off	High	4500lm/34W	4,3	VG4LWE-840H-L1254-YB*	VG4LEE-840H-L1254-YB*	718,00
1504	4000K	On/Off	Medium	3750lm/27W	5,0	VG4LWE-840M-L1504-YB*	VG4LEE-840M-L1504-YB*	805,00
1504	4000K	On/Off	High	5380lm/40W	5,0	VG4LWE-840H-L1504-YB*	VG4LEE-840H-L1504-YB*	805,00
1754	4000K	On/Off	Medium	4370lm/31W	5,7	VG4LWE-840M-L1754-YB*	VG4LEE-840M-L1754-YB*	928,00
1754	4000K	On/Off	High	6280lm/46W	5,7	VG4LWE-840H-L1754-YB*	VG4LEE-840H-L1754-YB*	928,00
2004	4000K	On/Off	Medium	5000lm/35W	6,6	VG4LWE-840M-L2004-YB*	VG4LEE-840M-L2004-YB*	1077,00
2004	4000K	On/Off	High	7180lm/53W	6,6	VG4LWE-840H-L2004-YB*	VG4LEE-840H-L2004-YB*	1077,00
per meter	4000K	On/Off	Medium	2500lm/17,3W	3,6	VG4LWE-840M-L****-YB*	VG4LEE-840M-L****-YB*	543,00
per meter	4000K	On/Off	High	3600lm/26,4W	3,6	VG4LWE-840H-L****-YB*	VG4LEE-840H-L****-YB*	543,00
per meter	4000K	DALI	Medium	2500lm/17,3W	3,6	VG4LWL-840M-L****-YB*	VG4LEL-840M-L****-YB*	595,00
per meter	4000K	DALI	High	3600lm/26,4W	3,6	VG4LWL-840H-L****-YB*	VG4LEL-840H-L****-YB*	595,00

Microprismatic | Direct

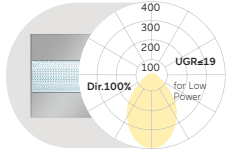

L mm	Colour Temperature	Control	Power	Lumen/Watt	Weight kg	Code Snow White	Code Silver Anodised	CHF
890	4000K	On/Off	Low	1230lm/12W	2,4	VG4AWE-840E-L890-Y	VG4AEE-840E-L890-Y	630,00
890	4000K	On/Off	Medium	1660lm/16W	2,4	VG4AWE-840M-L890-Y	VG4AEE-840M-L890-Y	630,00
890	4000K	On/Off	High	2350lm/23W	2,4	VG4AWE-840H-L890-Y	VG4AEE-840H-L890-Y	630,00
1182	4000K	On/Off	Low	1640lm/15W	2,9	VG4AWE-840E-L1182-Y	VG4AEE-840E-L1182-Y	674,00
1182	4000K	On/Off	Medium	2210lm/20W	2,9	VG4AWE-840M-L1182-Y	VG4AEE-840M-L1182-Y	674,00
1182	4000K	On/Off	High	3130lm/29W	2,9	VG4AWE-840H-L1182-Y	VG4AEE-840H-L1182-Y	674,00
1475	4000K	On/Off	Low	2050lm/18W	3,4	VG4AWE-840E-L1475-Y	VG4AEE-840E-L1475-Y	744,00
1475	4000K	On/Off	Medium	2770lm/25W	3,4	VG4AWE-840M-L1475-Y	VG4AEE-840M-L1475-Y	744,00
1475	4000K	On/Off	High	3920lm/36W	3,4	VG4AWE-840H-L1475-Y	VG4AEE-840H-L1475-Y	744,00
1765	4000K	On/Off	Low	2450lm/22W	3,9	VG4AWE-840E-L1765-Y	VG4AEE-840E-L1765-Y	849,00
1765	4000K	On/Off	Medium	3320lm/29W	3,9	VG4AWE-840M-L1765-Y	VG4AEE-840M-L1765-Y	849,00
1765	4000K	On/Off	High	4700lm/43W	3,9	VG4AWE-840H-L1765-Y	VG4AEE-840H-L1765-Y	849,00
2055	4000K	On/Off	Low	2860lm/27W	4,7	VG4AWE-840E-L2055-Y	VG4AEE-840E-L2055-Y	980,00
2055	4000K	On/Off	Medium	3870lm/36W	4,7	VG4AWE-840M-L2055-Y	VG4AEE-840M-L2055-Y	980,00
2055	4000K	On/Off	High	5490lm/52W	4,7	VG4AWE-840H-L2055-Y	VG4AEE-840H-L2055-Y	980,00
per meter	4000K	On/Off	Low	1390lm/12,3W	2,7	VG4AWE-840E-L****-Y	VG4AEE-840E-L****-Y	490,00
per meter	4000K	On/Off	Medium	1880lm/16,6W	2,7	VG4AWE-840M-L****-Y	VG4AEE-840M-L****-Y	490,00
per meter	4000K	On/Off	High	2670lm/24,2W	2,7	VG4AWE-840H-L****-Y	VG4AEE-840H-L****-Y	490,00
per meter	4000K	DALI	Low	1390lm/12,3W	2,7	VG4AWL-840E-L****-Y	VG4AEL-840E-L****-Y	543,00
per meter	4000K	DALI	Medium	1880lm/16,6W	2,7	VG4AWL-840M-L****-Y	VG4AEL-840M-L****-Y	543,00
per meter	4000K	DALI	High	2670lm/24,2W	2,7	VG4AWL-840H-L****-Y	VG4AEL-840H-L****-Y	543,00

**** Your length in mm

Meterpreise für Lichtsysteme nach Maß ab Mindestlänge 2200mm | Prices per metre for customised lighting systems with a minimum length of 2200mm
 Prix au mètre pour systèmes d'éclairage sur mesure à partir d'une longueur minimale de 2200mm

Opal Diffuser | Direct

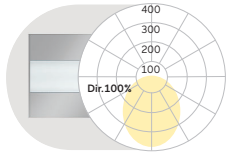

L mm	Colour Temperature	Control	Power	Lumen/Watt	Weight kg	Code Snow White	Code Silver Anodised	CHF
890	4000K	On/Off	Low	1350lm/12W	2,4	VG4OWE-840E-L890-Y	VG4OEE-840E-L890-Y	613,00
890	4000K	On/Off	Medium	1820lm/16W	2,4	VG4OWE-840M-L890-Y	VG4OEE-840M-L890-Y	613,00
890	4000K	On/Off	High	2580lm/23W	2,4	VG4OWE-840H-L890-Y	VG4OEE-840H-L890-Y	613,00
1182	4000K	On/Off	Low	1790lm/15W	2,9	VG4OWE-840E-L1182-Y	VG4OEE-840E-L1182-Y	639,00
1182	4000K	On/Off	Medium	2430lm/20W	2,9	VG4OWE-840M-L1182-Y	VG4OEE-840M-L1182-Y	639,00
1182	4000K	On/Off	High	3440lm/29W	2,9	VG4OWE-840H-L1182-Y	VG4OEE-840H-L1182-Y	639,00
1475	4000K	On/Off	Low	2240lm/18W	3,4	VG4OWE-840E-L1475-Y	VG4OEE-840E-L1475-Y	700,00
1475	4000K	On/Off	Medium	3030lm/25W	3,4	VG4OWE-840M-L1475-Y	VG4OEE-840M-L1475-Y	700,00
1475	4000K	On/Off	High	4300lm/36W	3,4	VG4OWE-840H-L1475-Y	VG4OEE-840H-L1475-Y	700,00
1765	4000K	On/Off	Low	2690lm/22W	3,9	VG4OWE-840E-L1765-Y	VG4OEE-840E-L1765-Y	797,00
1765	4000K	On/Off	Medium	3640lm/29W	3,9	VG4OWE-840M-L1765-Y	VG4OEE-840M-L1765-Y	797,00
1765	4000K	On/Off	High	5160lm/43W	3,9	VG4OWE-840H-L1765-Y	VG4OEE-840H-L1765-Y	797,00
2055	4000K	On/Off	Low	3140lm/27W	4,7	VG4OWE-840E-L2055-Y	VG4OEE-840E-L2055-Y	910,00
2055	4000K	On/Off	Medium	4250lm/36W	4,7	VG4OWE-840M-L2055-Y	VG4OEE-840M-L2055-Y	910,00
2055	4000K	On/Off	High	6020lm/52W	4,7	VG4OWE-840H-L2055-Y	VG4OEE-840H-L2055-Y	910,00
per meter	4000K	On/Off	Low	1530lm/12,3W	2,7	VG4OWE-840E-L****-Y	VG4OEE-840E-L****-Y	473,00
per meter	4000K	On/Off	Medium	2060lm/16,6W	2,7	VG4OWE-840M-L****-Y	VG4OEE-840M-L****-Y	473,00
per meter	4000K	On/Off	High	2930lm/24,2W	2,7	VG4OWE-840H-L****-Y	VG4OEE-840H-L****-Y	473,00
per meter	4000K	DALI	Low	1530lm/12,3W	2,7	VG4OWL-840E-L****-Y	VG4OEL-840E-L****-Y	525,00
per meter	4000K	DALI	Medium	2060lm/16,6W	2,7	VG4OWL-840M-L****-Y	VG4OEL-840M-L****-Y	525,00
per meter	4000K	DALI	High	2930lm/24,2W	2,7	VG4OWL-840H-L****-Y	VG4OEL-840H-L****-Y	525,00

Wallwasher | Direct

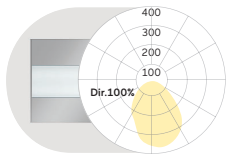

L mm	Colour Temperature	Control	Power	Lumen/Watt	Weight kg	Code Snow White	Code Silver Anodised	CHF
890	4000K	On/Off	Medium	1500lm/16W	2,4	VG4JWE-840M-L890-Y	VG4JEE-840M-L890-Y	630,00
890	4000K	On/Off	High	2130lm/23W	2,4	VG4JWE-840H-L890-Y	VG4JEE-840H-L890-Y	630,00
1182	4000K	On/Off	Medium	2000lm/20W	2,9	VG4JWE-840M-L1182-Y	VG4JEE-840M-L1182-Y	674,00
1182	4000K	On/Off	High	2840lm/29W	2,9	VG4JWE-840H-L1182-Y	VG4JEE-840H-L1182-Y	674,00
1475	4000K	On/Off	Medium	2500lm/25W	3,4	VG4JWE-840M-L1475-Y	VG4JEE-840M-L1475-Y	744,00
1475	4000K	On/Off	High	3550lm/36W	3,4	VG4JWE-840H-L1475-Y	VG4JEE-840H-L1475-Y	744,00
1765	4000K	On/Off	Medium	3000lm/29W	3,9	VG4JWE-840M-L1765-Y	VG4JEE-840M-L1765-Y	849,00
1765	4000K	On/Off	High	4250lm/43W	3,9	VG4JWE-840H-L1765-Y	VG4JEE-840H-L1765-Y	849,00
2055	4000K	On/Off	Medium	3500lm/36W	4,7	VG4JWE-840M-L2055-Y	VG4JEE-840M-L2055-Y	980,00
2055	4000K	On/Off	High	4960lm/52W	4,7	VG4JWE-840H-L2055-Y	VG4JEE-840H-L2055-Y	980,00
per meter	4000K	On/Off	Medium	1700lm/16,6W	2,7	VG4JWE-840M-L****-Y	VG4JEE-840M-L****-Y	482,00
per meter	4000K	On/Off	High	2410lm/24,2W	2,7	VG4JWE-840H-L****-Y	VG4JEE-840H-L****-Y	482,00
per meter	4000K	DALI	Medium	1700lm/16,6W	2,7	VG4JWL-840M-L****-Y	VG4JEL-840M-L****-Y	534,00
per meter	4000K	DALI	High	2410lm/24,2W	2,7	VG4JWL-840H-L****-Y	VG4JEL-840H-L****-Y	534,00

**** Your length in mm

Meterpreise für Lichtsysteme nach Maß ab Mindestlänge 2200mm | Prices per metre for customised lighting systems with a minimum length of 2200mm
 Prix au mètre pour systèmes d'éclairage sur mesure à partir d'une longueur minimale de 2200mm

Surcharges

Optical System	CHF	Surface Finish	CHF	Control Gear	CHF	CHF	Colour Temperature	CHF	Lens Louvre*	CHF
O: Opal Diffuser	✓	W: Snow White	✓	E: On/Off	L890-L1765	L2055	22: 2200K	+5%	W: Snow White	✓
D: Trucircle Polycarbonate Diffuser*	+5%	E: Silver Anodised	✓	L: DALI	+86,00	+172,00	27: 2700K	+5%	A: Satin Silver	✓
		U: Urban Graphite	✓	H: Touch-Dim	+86,00	+172,00	30: 3000K	✓	B: Jet Black	✓
		B: Jet Black	✓	C: Casambi*	+261,00	+261,00	35: 3500K	+5%	H: Anodic Champagne	✓
*Opal Diffuser made of sustainable Trucircle Polycarbonat / Fire Rated - Glow wire flammability Index 950°C EN60695-2-12 / Tp(a). Luminous flux reduction of 10%.		H: Anodic Champagne	+10%	6: DALI DT6 for TW	+172,00	+343,00	40: 4000K	✓	K: Satin Copper	✓
		K: Satin Copper	+15%	8: DALI DT8 for TW	+172,00	+343,00	65: 6500K	+5%	G: Satin Gold	✓
		R: Special RAL/NCS Colours	⊕				TW: Tunable White 2700-6500K**	+30%		
				*Only in combination with DALI. Please add to dimming price.					Suspension Type	CHF
				Colour Rendering	CHF		**Only in combination with DT6, DT8 or Casambi control. Please add additional control price.		Y: Y-Cord Suspension	✓
				8: CRI>80	✓				K: Parallel Suspension	✓
				9: CRI>90	+5%					
				F: Full Spectrum	+15%					

✓ standard / no extra charge ⊕ on request ✗ not available

Plank G4/P4 | Suspended

catalogue page 330



Microprismatic | Direct-Indirect

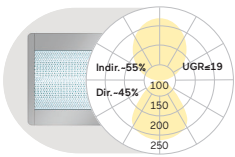

L mm	Colour Temperature	Control	Power	Lumen/Watt	Weight kg	Code Snow White	Code Silver Anodised	CHF
920	4000K	On/Off	Medium	2840lm/24W	5,2	JP4AWE-840M-L920-K	JP4AEE-840M-L920-K	674,00
920	4000K	On/Off	High	4530lm/38W	5,2	JP4AWE-840H-L920-K	JP4AEE-840H-L920-K	674,00
1210	4000K	On/Off	Medium	3790lm/33W	7,2	JP4AWE-840M-L1210-K	JP4AEE-840M-L1210-K	727,00
1210	4000K	On/Off	High	6030lm/53W	7,2	JP4AWE-840H-L1210-K	JP4AEE-840H-L1210-K	727,00
1500	4000K	On/Off	Medium	4740lm/40W	9,0	JP4AWE-840M-L1500-K	JP4AEE-840M-L1500-K	832,00
1500	4000K	On/Off	High	7540lm/64W	9,0	JP4AWE-840H-L1500-K	JP4AEE-840H-L1500-K	832,00
1800	4000K	On/Off	Medium	5690lm/47W	10,7	JP4AWE-840M-L1800-K	JP4AEE-840M-L1800-K	954,00
1800	4000K	On/Off	High	9050lm/76W	10,7	JP4AWE-840H-L1800-K	JP4AEE-840H-L1800-K	954,00

Microprismatic | Direct

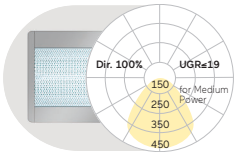

L mm	Colour Temperature	Control	Power	Lumen/Watt	Weight kg	Code Snow White	Code Silver Anodised	CHF
920	4000K	On/Off	Medium	1340lm/13W	5,5	JG4AWE-840M-L920-K	JG4AEE-840M-L920-K	613,00
920	4000K	On/Off	High	2130lm/21W	5,5	JG4AWE-840H-L920-K	JG4AEE-840H-L920-K	613,00
1210	4000K	On/Off	Medium	1790lm/17W	7,5	JG4AWE-840M-L1210-K	JG4AEE-840M-L1210-K	648,00
1210	4000K	On/Off	High	2840lm/27W	7,5	JG4AWE-840H-L1210-K	JG4AEE-840H-L1210-K	648,00
1500	4000K	On/Off	Medium	2240lm/20W	9,3	JG4AWE-840M-L1500-K	JG4AEE-840M-L1500-K	700,00
1500	4000K	On/Off	High	3550lm/33W	9,3	JG4AWE-840H-L1500-K	JG4AEE-840H-L1500-K	700,00
1800	4000K	On/Off	Medium	2690lm/24W	11,0	JG4AWE-840M-L1800-K	JG4AEE-840M-L1800-K	779,00
1800	4000K	On/Off	High	4260lm/39W	11,0	JG4AWE-840H-L1800-K	JG4AEE-840H-L1800-K	779,00

Opal Diffuser | Direct-Indirect

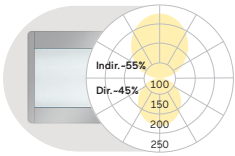

L mm	Colour Temperature	Control	Power	Lumen/Watt	Weight kg	Code Snow White	Code Silver Anodised	CHF
920	4000K	On/Off	Medium	2750lm/24W	5,2	JP4OWE-840M-L920-K	JP4OEE-840M-L920-K	657,00
920	4000K	On/Off	High	4380lm/38W	5,2	JP4OWE-840H-L920-K	JP4OEE-840H-L920-K	657,00
1210	4000K	On/Off	Medium	3670lm/33W	7,2	JP4OWE-840M-L1210-K	JP4OEE-840M-L1210-K	692,00
1210	4000K	On/Off	High	5830lm/53W	7,2	JP4OWE-840H-L1210-K	JP4OEE-840H-L1210-K	692,00
1500	4000K	On/Off	Medium	4580lm/40W	9,0	JP4OWE-840M-L1500-K	JP4OEE-840M-L1500-K	770,00
1500	4000K	On/Off	High	7290lm/64W	9,0	JP4OWE-840H-L1500-K	JP4OEE-840H-L1500-K	770,00
1800	4000K	On/Off	Medium	5500lm/47W	10,7	JP4OWE-840M-L1800-K	JP4OEE-840M-L1800-K	884,00
1800	4000K	On/Off	High	8750lm/76W	10,7	JP4OWE-840H-L1800-K	JP4OEE-840H-L1800-K	884,00

Opal Diffuser | Direct

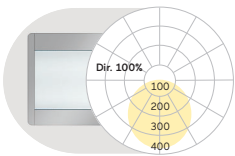

L mm	Colour Temperature	Control	Power	Lumen/Watt	Weight kg	Code Snow White	Code Silver Anodised	CHF
920	4000K	On/Off	Medium	1250lm/13W	5,5	JG4OWE-840M-L920-K	JG4OEE-840M-L920-K	595,00
920	4000K	On/Off	High	1980lm/21W	5,5	JG4OWE-840H-L920-K	JG4OEE-840H-L920-K	595,00
1210	4000K	On/Off	Medium	1670lm/17W	7,5	JG4OWE-840M-L1210-K	JG4OEE-840M-L1210-K	613,00
1210	4000K	On/Off	High	2640lm/27W	7,5	JG4OWE-840H-L1210-K	JG4OEE-840H-L1210-K	613,00
1500	4000K	On/Off	Medium	2080lm/20W	9,3	JG4OWE-840M-L1500-K	JG4OEE-840M-L1500-K	639,00
1500	4000K	On/Off	High	3300lm/33W	9,3	JG4OWE-840H-L1500-K	JG4OEE-840H-L1500-K	639,00
1800	4000K	On/Off	Medium	2500lm/24W	11,0	JG4OWE-840M-L1800-K	JG4OEE-840M-L1800-K	709,00
1800	4000K	On/Off	High	3960lm/39W	11,0	JG4OWE-840H-L1800-K	JG4OEE-840H-L1800-K	709,00

Surcharges

Surface	CHF	Control Gear	CHF	CHF	Colour Rendering	CHF	Colour Temperature	CHF	Suspension Type	CHF
W: Snow White	✓	E: On/Off	✓	✓	8: CRI>80	✓	22: 2200K	+5%	Y: Y-Cord Suspension	✓
E: Silver Anodised	✓	L: DALI	+86,00	+172,00	9: CRI>90	+5%	27: 2700K	+5%	K: Parallel Suspension	✓
U: Urban Graphite	✓	H: Touch-Dim	+86,00	+172,00	F: Full Spectrum	+15%	30: 3000K	✓		
B: Jet Black	✓	C: Casambi*	+261,00	+261,00			35: 3500K	+5%		
H: Anodic Champagne	+10%	6: DALI DT6 for TW	+172,00	+343,00			40: 4000K	✓		
K: Satin Copper	+15%	8: DALI DT8 for TW	+172,00	+343,00			65: 6500K	+5%		
R: Special RAL/NCS Colours	ⓘ						TW: Tunable White 2700-6500K*	+30%		

*Only in combination with DALI. Please add to dimming price.

**Only in combination with DT6, DT8 or Casambi control. Please add additional control price.

✓ standard / no extra charge ⓘ on request ✗ not available



Midpoint B7 |
Surface
120



Midpoint A6 |
Surface
120



Basic Superflat Y7/X7 |
Surface
121



Basic Neo A5 |
Surface
122



Basic Neo X5 |
Surface
123



Basic Déco A3/A4 |
Surface
124



Basic Déco X3 |
Surface
125



Basic Déco Z3 |
Surface
126



Basic Max A1 |
Surface
127



Basic Max Y1/X1 |
Surface
128



Basic Visio Y9/X9 |
Surface
129



Beam Me Up (Flat)
Y3/X3 | Surface
130



Beam Me Up (Max)
Y1/X1 | Surface
131



Beam Me Up (Wallwasher)
A4 | Surface
132



Ringo Star Compact A5 |
Surface
133



Ringo Star AX | System
40mm Surface
133



Ringo Star A3 | System
60mm Surface
134



Ringo Star A1 | System
100mm Surface
136



Liquid Line Compact
A5 | Surface
137



Liquid Line AX | System
40mm Surface
138



Liquid Line A3 | System
60mm Surface
139



Caleo Inverse AX |
System 40mm Surface
141



Caleo Neo Y4/X4 |
200mm Surface
141

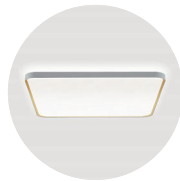

Caleo Neo Y6/X6 |
Square Surface
142



Cubic Evolution Y4/X4 |
200mm Surface
143



Cubic Evolution Y5/X5 |
300mm Surface
144



Cubic Evolution Y6/X6 |
Square Surface
145

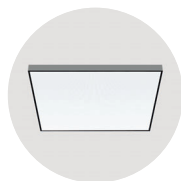

Cubic Neo A9 |
Surface
146



Cubic Max A2/X2 |
Surface
147

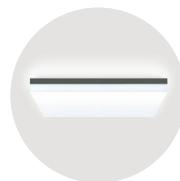

Cubic Ambient A7 |
Surface
148



Cubic Déco A3 |
Surface
149

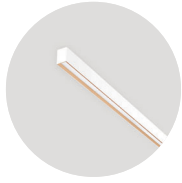

Matric Déco A9 |
Surface
150

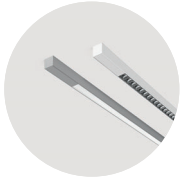

Matric AY | System
40mm Surface
151



Matric XY | System
40mm Surface
152



Matric AX | System
40mm Surface
153

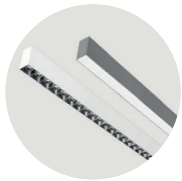

Matric A3 | System
55mm Surface
155

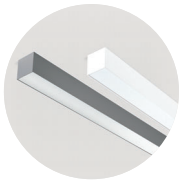

Matric A5 | System
81mm Surface
157

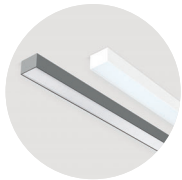

Matric A6 | System
81mm Surface
158

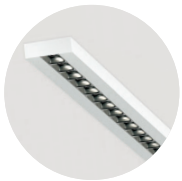

Vision Gen. 4 A4/X4 |
Surface
160



Plank Y4/X4 |
Surface
163

Anbau | Surface| Apparent

Midpoint B7 | Surface

catalogue page 334



Led Engine - Eco:

Beam Angle	Colour Temperature	Control	Power	Lumen/Watt	Weight kg	Code Snow White	Code Radiant Silver	CHF
Spot 10°	4000K	On/Off	Low	1440lm/19W	1,1	PB7AWE-940FE-WK	PB7ASE-940FE-SK	331,00
Spot 10°	4000K	On/Off	Medium	2020lm/31W	1,1	PB7AWE-940FM-WK	PB7ASE-940FM-SK	331,00
Medium 20°	4000K	On/Off	Low	1850lm/19W	1,1	PB7BWE-940FE-WK	PB7BSE-940FE-SK	307,00
Medium 20°	4000K	On/Off	Medium	2870lm/31W	1,1	PB7BWE-940FM-WK	PB7BSE-940FM-SK	307,00
Flood 35°	4000K	On/Off	Low	1790lm/19W	1,1	PB7CWE-940FE-WK	PB7CSE-940FE-SK	307,00
Flood 35°	4000K	On/Off	Medium	2780lm/31W	1,1	PB7CWE-940FM-WK	PB7CSE-940FM-SK	307,00
W Flood 50°	4000K	On/Off	Low	1680lm/19W	1,1	PB7DWE-940FE-WK	PB7DSE-940FE-SK	307,00
W Flood 50°	4000K	On/Off	Medium	2710lm/31W	1,1	PB7DWE-940FM-WK	PB7DSE-940FM-SK	307,00

Led Engine - Artist Xicato:

Beam Angle	Colour Temperature	Control	Power	Lumen/Watt	Weight kg	Code Snow White	Code Radiant Silver	CHF
Spot 10°	4000K	On/Off	Low	1190lm/19W	1,1	PB7AWE-940AE-WK	PB7ASE-940AE-SK	445,00
Spot 10°	4000K	On/Off	Medium	1560lm/31W	1,1	PB7AWE-940AM-WK	PB7ASE-940AM-SK	445,00
Medium 20°	4000K	On/Off	Low	1510lm/19W	1,1	PB7BWE-940AE-WK	PB7BSE-940AE-SK	408,00
Medium 20°	4000K	On/Off	Medium	2220lm/31W	1,1	PB7BWE-940AM-WK	PB7BSE-940AM-SK	408,00
Flood 35°	4000K	On/Off	Low	1470lm/19W	1,1	PB7CWE-940AE-WK	PB7CSE-940AE-SK	408,00
Flood 35°	4000K	On/Off	Medium	2160lm/31W	1,1	PB7CWE-940AM-WK	PB7CSE-940AM-SK	408,00
W Flood 50°	4000K	On/Off	Low	1430lm/19W	1,1	PB7DWE-940AE-WK	PB7DSE-940AE-SK	408,00
W Flood 50°	4000K	On/Off	Medium	2140lm/31W	1,1	PB7DWE-940AM-WK	PB7DSE-940AM-SK	408,00

Surcharges

Surface Finish	CHF	Control Gear	CHF	Optic Ring	CHF	Cover	CHF	Additional Options	CHF
W: Snow White	✓	E: On/Off	✓	W: Snow White	✓	K: Clear Cover	✓	Optic Removal Tool	34,00
S: Radiant Silver	✓	L: DALI	+86,00	V: Ivory White	✓	P: Prismatic Lens	+21,00		
B: Jet Black	✓	H: Touch-Dim	+86,00	S: Radiant Silver	✓	H: Honeycomb Louvre	+21,00		
H: Anodic Champagne	+10%			B: Jet Black	✓				
V: Ivory White	✓	Colour Temperature	CHF	H: Anodic Champagne	✓				
R: Special RAL/NCS Colours	ⓘ	27: 2700K	+5%	K: Satin Copper	✓				
		30: 3000K	✓	G: Satin Gold	✓				
		40: 4000K	✓						

✓ standard / no extra charge ⓘ on request ✗ not available

Midpoint A6 | Surface

catalogue page 336



Led Engine - Eco:

Beam Angle	Colour Temperature	Control	Power	Lumen/Watt	Weight kg	Code Snow White	Code Radiant Silver	CHF
Spot 10°	4000K	On/Off	Low	1440lm/19W	1,3	PA6AWE-940FE-WK	PA6ASE-940FE-SK	387,00
Spot 10°	4000K	On/Off	Medium	2020lm/31W	1,3	PA6AWE-940FM-WK	PA6ASE-940FM-SK	387,00
Medium 20°	4000K	On/Off	Low	1850lm/19W	1,3	PA6BWE-940FE-WK	PA6BSE-940FE-SK	363,00
Medium 20°	4000K	On/Off	Medium	2870lm/31W	1,3	PA6BWE-940FM-WK	PA6BSE-940FM-SK	363,00
Flood 35°	4000K	On/Off	Low	1790lm/19W	1,3	PA6CWE-940FE-WK	PA6CSE-940FE-SK	363,00
Flood 35°	4000K	On/Off	Medium	2780lm/31W	1,3	PA6CWE-940FM-WK	PA6CSE-940FM-SK	363,00
W Flood 50°	4000K	On/Off	Low	1680lm/19W	1,3	PA6DWE-940FE-WK	PA6DSE-940FE-SK	363,00
W Flood 50°	4000K	On/Off	Medium	2710lm/31W	1,3	PA6DWE-940FM-WK	PA6DSE-940FM-SK	363,00

Led Engine – Artist Xicato:

Beam Angle	Colour Temperature	Control	Power	Lumen/Watt	Weight kg	Code Snow White	Code Radiant Silver	CHF
Spot 10°	4000K	On/Off	Low	1190lm/19W	1,3	PA6AWE-940AE-WK	PA6ASE-940AE-SK	501,00
Spot 10°	4000K	On/Off	Medium	1560lm/31W	1,3	PA6AWE-940AM-WK	PA6ASE-940AM-SK	501,00
Medium 20°	4000K	On/Off	Low	1510lm/19W	1,3	PA6BWE-940AE-WK	PA6BSE-940AE-SK	462,00
Medium 20°	4000K	On/Off	Medium	2220lm/31W	1,3	PA6BWE-940AM-WK	PA6BSE-940AM-SK	462,00
Flood 35°	4000K	On/Off	Low	1470lm/19W	1,3	PA6CWE-940AE-WK	PA6CSE-940AE-SK	462,00
Flood 35°	4000K	On/Off	Medium	2160lm/31W	1,3	PA6CWE-940AM-WK	PA6CSE-940AM-SK	462,00
W Flood 50°	4000K	On/Off	Low	1430lm/19W	1,3	PA6DWE-940AE-WK	PA6DSE-940AE-SK	462,00
W Flood 50°	4000K	On/Off	Medium	2140lm/31W	1,3	PA6DWE-940AM-WK	PA6DSE-940AM-SK	462,00

Surcharges

Surface Finish	CHF	Control Gear	CHF	Optic Ring	CHF	Cover	CHF	Additional Options	CHF
W: Snow White	✓	E: On/Off	✓	W: Snow White	✓	K: Clear Cover	✓	Optic Removal Tool	34,00
S: Radiant Silver	✓	L: DALI	+86,00	V: Ivory White	✓	P: Prismatic Lens	+21,00		
B: Jet Black	✓	H: Touch-Dim	+86,00	S: Radiant Silver	✓	H: Honeycomb Louvre	+21,00		
H: Anodic Champagne	+10%			B: Jet Black	✓				
V: Ivory White	✓	Colour Temperature	CHF	H: Anodic Champagne	✓				
R: Special RAL/NCS Colours	ⓘ	27: 2700K	+5%	K: Satin Copper	✓				
		30: 3000K	✓	G: Satin Gold	✓				
		40: 4000K	✓						

✓ standard / no extra charge ⓘ on request ✗ not available

Basic Superflat Y7/X7 | Surface

catalogue page 338

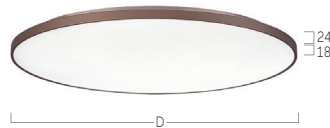

Microprismatic | Direct-Indirect

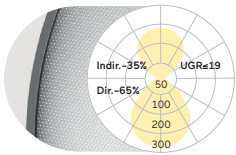

D mm	Colour Temperature	Control	Power	Lumen/Watt	Weight kg	Code Snow White	Code Radiant Silver	CHF
300	4000K	On/Off	Medium	1260lm/11W	2,0	BX7AWE-840M-D300	BX7ASE-840M-D300	818,00
300	4000K	On/Off	High	2150lm/18W	2,0	BX7AWE-840H-D300	BX7ASE-840H-D300	818,00
400	4000K	On/Off	Medium	2330lm/18W	3,5	BX7AWE-840M-D400	BX7ASE-840M-D400	1075,00
400	4000K	On/Off	High	4050lm/31W	3,5	BX7AWE-840H-D400	BX7ASE-840H-D400	1075,00
500	4000K	On/Off	Medium	3000lm/23W	5,1	BX7AWE-840M-D500	BX7ASE-840M-D500	1294,00
500	4000K	On/Off	High	5240lm/40W	5,1	BX7AWE-840H-D500	BX7ASE-840H-D500	1294,00
600	4000K	On/Off	Medium	5380lm/40W	6,9	BX7AWE-840M-D600	BX7ASE-840M-D600	1642,00
600	4000K	On/Off	High	8270lm/63W	6,9	BX7AWE-840H-D600	BX7ASE-840H-D600	1642,00
800	4000K	On/Off	Medium	7860lm/60W	11,9	BX7AWE-840M-D800	BX7ASE-840M-D800	2818,00
800	4000K	On/Off	High	10750lm/81W	11,9	BX7AWE-840H-D800	BX7ASE-840H-D800	2818,00

Microprismatic | Direct

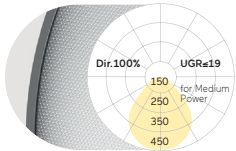

D mm	Colour Temperature	Control	Power	Lumen/Watt	Weight kg	Code Snow White	Code Radiant Silver	CHF
300	4000K	On/Off	Medium	690lm/7W	1,9	BY7AWE-840M-D300	BY7ASE-840M-D300	678,00
300	4000K	On/Off	High	1190lm/11W	1,9	BY7AWE-840H-D300	BY7ASE-840H-D300	678,00
400	4000K	On/Off	Medium	1470lm/12W	3,3	BY7AWE-840M-D400	BY7ASE-840M-D400	917,00
400	4000K	On/Off	High	2560lm/21W	3,3	BY7AWE-840H-D400	BY7ASE-840H-D400	917,00
500	4000K	On/Off	Medium	2030lm/16W	4,9	BY7AWE-840M-D500	BY7ASE-840M-D500	1119,00
500	4000K	On/Off	High	3570lm/28W	4,9	BY7AWE-840H-D500	BY7ASE-840H-D500	1119,00
600	4000K	On/Off	Medium	3390lm/25W	6,8	BY7AWE-840M-D600	BY7ASE-840M-D600	1449,00
600	4000K	On/Off	High	5520lm/42W	6,8	BY7AWE-840H-D600	BY7ASE-840H-D600	1449,00
800	4000K	On/Off	Medium	5160lm/40W	11,4	BY7AWE-840M-D800	BY7ASE-840M-D800	2608,00
800	4000K	On/Off	High	6980lm/54W	11,4	BY7AWE-840H-D800	BY7ASE-840H-D800	2608,00

... Basic Superflat Y7/X7 | Surface

Opal Diffuser | Direct-Indirect

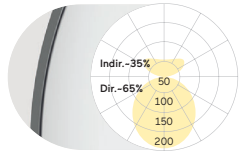

D mm	Colour Temperature	Control	Power	Lumen/Watt	Weight kg	Code Snow White	Code Radiant Silver	CHF
300	4000K	On/Off	Medium	1270lm/11W	2,0	BX7OWE-840M-D300	BX7OSE-840M-D300	781,00
300	4000K	On/Off	High	2160lm/18W	2,0	BX7OWE-840H-D300	BX7OSE-840H-D300	781,00
400	4000K	On/Off	Medium	2350lm/18W	3,5	BX7OWE-840M-D400	BX7OSE-840M-D400	1019,00
400	4000K	On/Off	High	4070lm/31W	3,5	BX7OWE-840H-D400	BX7OSE-840H-D400	1019,00
500	4000K	On/Off	Medium	3040lm/23W	5,1	BX7OWE-840M-D500	BX7OSE-840M-D500	1239,00
500	4000K	On/Off	High	5300lm/40W	5,1	BX7OWE-840H-D500	BX7OSE-840H-D500	1239,00
600	4000K	On/Off	Medium	5450lm/40W	6,9	BX7OWE-840M-D600	BX7OSE-840M-D600	1568,00
600	4000K	On/Off	High	8370lm/63W	6,9	BX7OWE-840H-D600	BX7OSE-840H-D600	1568,00
800	4000K	On/Off	Medium	7980lm/60W	11,9	BX7OWE-840M-D800	BX7OSE-840M-D800	2744,00
800	4000K	On/Off	High	10920lm/81W	11,9	BX7OWE-840H-D800	BX7OSE-840H-D800	2744,00

Opal Diffuser | Direct

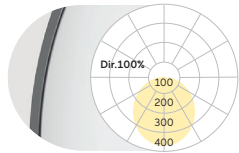

D mm	Colour Temperature	Control	Power	Lumen/Watt	Weight kg	Code Snow White	Code Radiant Silver	CHF
300	4000K	On/Off	Medium	700lm/7W	1,9	BY7OWE-840M-D300	BY7OSE-840M-D300	641,00
300	4000K	On/Off	High	1200lm/11W	1,9	BY7OWE-840H-D300	BY7OSE-840H-D300	641,00
400	4000K	On/Off	Medium	1490lm/12W	3,3	BY7OWE-840M-D400	BY7OSE-840M-D400	861,00
400	4000K	On/Off	High	2580lm/21W	3,3	BY7OWE-840H-D400	BY7OSE-840H-D400	861,00
500	4000K	On/Off	Medium	2070lm/16W	4,9	BY7OWE-840M-D500	BY7OSE-840M-D500	1064,00
500	4000K	On/Off	High	3630lm/28W	4,9	BY7OWE-840H-D500	BY7OSE-840H-D500	1064,00
600	4000K	On/Off	Medium	3460lm/25W	6,8	BY7OWE-840M-D600	BY7OSE-840M-D600	1376,00
600	4000K	On/Off	High	5620lm/42W	6,8	BY7OWE-840H-D600	BY7OSE-840H-D600	1376,00
800	4000K	On/Off	Medium	5280lm/40W	11,4	BY7OWE-840M-D800	BY7OSE-840M-D800	2534,00
800	4000K	On/Off	High	7150lm/54W	11,4	BY7OWE-840H-D800	BY7OSE-840H-D800	2534,00

Surcharges

Surface Finish	CHF	Control Gear	CHF	CHF	Colour Rendering	CHF	Colour Temperature	CHF	Additional Options	CHF
W: Snow White	✓	E: On/Off	✓	✓	8: CRI>80	✓	22: 2200K	+5%	Radar Sensor	+209,00
V: Ivory White	✓	L: DALI	+86,00	+172,00	9: CRI>90	+5%	27: 2700K	+5%	Multisensor [D400-D800]	+457,00
S: Radiant Silver	✓	H: Touch-Dim	+86,00	+172,00	F: Full Spectrum	+15%	30: 3000K	✓	Emergency Module [DALI, Autotest, incl. 3H Battery] [D400-D800]	+366,00
U: Urban Graphite	✓	C: Casambi*	+261,00	+261,00			35: 3500K	+5%		
B: Jet Black	✓	6: DALI DT6 for TW	+172,00	+343,00			40: 4000K	✓		
H: Anodic Champagne	+10%	8: DALI DT8 for TW	+172,00	+343,00			65: 6500K	+5%		
K: Satin Copper	+15%						TW: Tunable White 2700-6500K* [D400-D800]	+30%		
R: Special RAL/NCS Colours	🚫	*Only in combination with DALI. Please add to dimming price.					*Only in combination with DT6, DT8 or Casambi control. Please add additional control price.			

✓ standard / no extra charge 🚫 on request 🚫 not available

Basic Neo Surface | A5

catalogue page 342

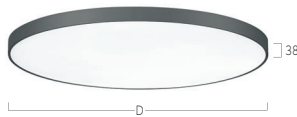

Microprismatic | Direct

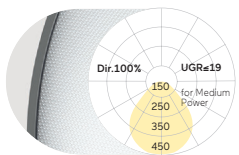

D mm	Colour Temperature	Control	Power	Lumen/Watt	Weight kg	Code Snow White	Code Radiant Silver	CHF
300	4000K	On/Off	Medium	690lm/7W	2,6	BA5AWE-840M-D300	BA5ASE-840M-D300	641,00
300	4000K	On/Off	High	1190lm/11W	2,6	BA5AWE-840H-D300	BA5ASE-840H-D300	641,00
400	4000K	On/Off	Medium	1470lm/12W	4,3	BA5AWE-840M-D400	BA5ASE-840M-D400	856,00
400	4000K	On/Off	High	2560lm/21W	4,3	BA5AWE-840H-D400	BA5ASE-840H-D400	856,00
500	4000K	On/Off	Medium	2030lm/16W	6,4	BA5AWE-840M-D500	BA5ASE-840M-D500	1052,00
500	4000K	On/Off	High	3570lm/28W	6,4	BA5AWE-840H-D500	BA5ASE-840H-D500	1052,00
600	4000K	On/Off	Medium	3390lm/25W	8,8	BA5AWE-840M-D600	BA5ASE-840M-D600	1372,00
600	4000K	On/Off	High	5520lm/42W	8,8	BA5AWE-840H-D600	BA5ASE-840H-D600	1372,00
800	4000K	On/Off	Medium	5160lm/40W	14,9	BA5AWE-840M-D800	BA5ASE-840M-D800	2498,00
800	4000K	On/Off	High	6980lm/54W	14,9	BA5AWE-840H-D800	BA5ASE-840H-D800	2498,00

Opal Diffuser | Direct

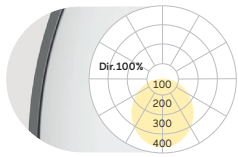

D mm	Colour Temperature	Control	Power	Lumen/Watt	Weight kg	Code Snow White	Code Radiant Silver	CHF
300	4000K	On/Off	Medium	700lm/7W	2,6	BA5OWE-840M-D300	BA5OSE-840M-D300	606,00
300	4000K	On/Off	High	1200lm/11W	2,6	BA5OWE-840H-D300	BA5OSE-840H-D300	606,00
400	4000K	On/Off	Medium	1490lm/12W	4,3	BA5OWE-840M-D400	BA5OSE-840M-D400	802,00
400	4000K	On/Off	High	2580lm/21W	4,3	BA5OWE-840H-D400	BA5OSE-840H-D400	802,00
500	4000K	On/Off	Medium	2070lm/16W	6,4	BA5OWE-840M-D500	BA5OSE-840M-D500	998,00
500	4000K	On/Off	High	3630lm/28W	6,4	BA5OWE-840H-D500	BA5OSE-840H-D500	998,00
600	4000K	On/Off	Medium	3460lm/25W	8,8	BA5OWE-840M-D600	BA5OSE-840M-D600	1224,00
600	4000K	On/Off	High	5620lm/42W	8,8	BA5OWE-840H-D600	BA5OSE-840H-D600	1224,00
800	4000K	On/Off	Medium	5280lm/40W	14,9	BA5OWE-840M-D800	BA5OSE-840M-D800	2396,00
800	4000K	On/Off	High	7150lm/54W	14,9	BA5OWE-840H-D800	BA5OSE-840H-D800	2396,00

Surcharges

Surface Finish	CHF	Control Gear	CHF	CHF	Colour Rendering	CHF	Colour Temperature	CHF	Additional Options	CHF
W: Snow White	✓	E: On/Off			8: CRI>80	✓	22: 2200K	+5%	Radar Sensor	+209,00
V: Ivory White	✓	L: DALI	+86,00	+172,00	9: CRI>90	+5%	27: 2700K	+5%	Multisensor [D400-D800]	+261,00
S: Radiant Silver	✓	H: Touch-Dim	+86,00	+172,00	F: Full Spectrum	+15%	30: 3000K	✓	Emergency Module [DALI, Autotest, incl. 3H Battery] [D400-D800]	+366,00
U: Urban Graphite	✓	C: Casambi*	+261,00	+261,00			35: 3500K	+5%		
B: Jet Black	✓	6: DALI DT6 for TW	+172,00	+343,00			40: 4000K	✓		
H: Anodic Champagne	+10%	8: DALI DT8 for TW	+172,00	+343,00			65: 6500K	+5%		
K: Satin Copper	+15%						TW: Tunable White 2700-6500K* [D400-D800]	+30%		
R: Special RAL/NCS Colours	🚫	*Only in combination with DALI. Please add to dimming price.								

✓ standard / no extra charge
🚫 on request
🚫 not available

*Only in combination with DT6, DT8 or Casambi control. Please add additional control price.

Basic Neo X5 | Surface

catalogue page 344



Microprismatic | Direct-Indirect

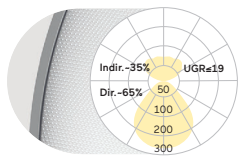

D mm	Colour Temperature	Control	Power	Lumen/Watt	Weight kg	Code Snow White	Code Radiant Silver	CHF
300	4000K	On/Off	Medium	1210lm/11W	2,2	BX5AWE-840M-D300	BX5ASE-840M-D300	781,00
300	4000K	On/Off	High	2070lm/18W	2,2	BX5AWE-840H-D300	BX5ASE-840H-D300	781,00
400	4000K	On/Off	Medium	2260lm/18W	3,7	BX5AWE-840M-D400	BX5ASE-840M-D400	1014,00
400	4000K	On/Off	High	3920lm/31W	3,7	BX5AWE-840H-D400	BX5ASE-840H-D400	1014,00
500	4000K	On/Off	Medium	2920lm/23W	5,4	BX5AWE-840M-D500	BX5ASE-840M-D500	1227,00
500	4000K	On/Off	High	5100lm/40W	5,4	BX5AWE-840H-D500	BX5ASE-840H-D500	1227,00
600	4000K	On/Off	Medium	5210lm/40W	7,2	BX5AWE-840M-D600	BX5ASE-840M-D600	1565,00
600	4000K	On/Off	High	8040lm/63W	7,2	BX5AWE-840H-D600	BX5ASE-840H-D600	1565,00
800	4000K	On/Off	Medium	7630lm/60W	11,8	BX5AWE-840M-D800	BX5ASE-840M-D800	2708,00
800	4000K	On/Off	High	10430lm/81W	11,8	BX5AWE-840H-D800	BX5ASE-840H-D800	2708,00

Opal Diffuser | Direct-Indirect

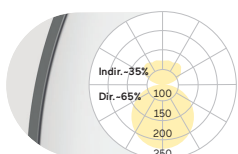

D mm	Colour Temperature	Control	Power	Lumen/Watt	Weight kg	Code Snow White	Code Radiant Silver	CHF
300	4000K	On/Off	Medium	1220lm/11W	2,0	BX5OWE-840M-D300	BX5OSE-840M-D300	746,00
300	4000K	On/Off	High	2080lm/18W	2,0	BX5OWE-840H-D300	BX5OSE-840H-D300	746,00
400	4000K	On/Off	Medium	2280lm/18W	3,4	BX5OWE-840M-D400	BX5OSE-840M-D400	959,00
400	4000K	On/Off	High	3940lm/31W	3,4	BX5OWE-840H-D400	BX5OSE-840H-D400	959,00
500	4000K	On/Off	Medium	2960lm/23W	5,0	BX5OWE-840M-D500	BX5OSE-840M-D500	1173,00
500	4000K	On/Off	High	5160lm/40W	5,0	BX5OWE-840H-D500	BX5OSE-840H-D500	1173,00
600	4000K	On/Off	Medium	5280lm/40W	6,7	BX5OWE-840M-D600	BX5OSE-840M-D600	1416,00
600	4000K	On/Off	High	8140lm/63W	6,7	BX5OWE-840H-D600	BX5OSE-840H-D600	1416,00
800	4000K	On/Off	Medium	7750lm/60W	11,1	BX5OWE-840M-D800	BX5OSE-840M-D800	2606,00
800	4000K	On/Off	High	10600lm/81W	11,1	BX5OWE-840H-D800	BX5OSE-840H-D800	2606,00

Surcharges										
Surface Finish	CHF	Control Gear	CHF	CHF	Colour Rendering	CHF	Colour Temperature	CHF	Additional Options	CHF
			D300-D600	D800						
W: Snow White	✓	E: On/Off	✓	✓	8: CRI>80	✓	22: 2200K	+5%	Radar Sensor	+209,00
V: Ivory White	✓	L: DALI	+86,00	+172,00	9: CRI>90	+5%	27: 2700K	+5%	Multisensor [D400-D800]	+261,00
S: Radiant Silver	✓	H: Touch-Dim	+86,00	+172,00	F: Full Spectrum	+15%	30: 3000K	✓	Emergency Module [DALI, Autotest, incl. 3H Battery] [D400-D800]	+366,00
U: Urban Graphite	✓	C: Casambi* [D400-D800]	+261,00	+261,00			35: 3500K	+5%		
B: Jet Black	✓	6: DALI DT6 for TW	+172,00	+343,00			40: 4000K	✓		
H: Anodic Champagne	+10%	8: DALI DT8 for TW	+172,00	+343,00			65: 6500K	+5%		
K: Satin Copper	+15%						TW: Tunable White 2700-6500K* [D400-D800]	+30%		
R: Special RAL/NCS Colours	🔗	*Only in combination with DALI. Please add to dimming price.								

✓ standard / no extra charge
🔗 on request
✗ not available

Basic Déco Surface | A3/A4

catalogue page 346



A3 Microprismatic | Direct

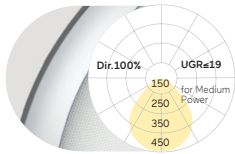

D mm	Colour Temperature	Control	Power	Lumen/Watt	Weight kg	Code Snow White	Code Radiant Silver	CHF
300	4000K	On/Off	Medium	830lm/8W	2,9	BA3AWE-840M-D300-W	BA3ASE-840M-D300-S	681,00
300	4000K	On/Off	High	1430lm/13W	2,9	BA3AWE-840H-D300-W	BA3ASE-840H-D300-S	681,00
400	4000K	On/Off	Medium	1500lm/14W	4,7	BA3AWE-840M-D400-W	BA3ASE-840M-D400-S	884,00
400	4000K	On/Off	High	2410lm/21W	4,7	BA3AWE-840H-D400-W	BA3ASE-840H-D400-S	884,00
500	4000K	On/Off	Medium	2370lm/21W	6,8	BA3AWE-840M-D500-W	BA3ASE-840M-D500-S	1094,00
500	4000K	On/Off	High	3980lm/35W	6,8	BA3AWE-840H-D500-W	BA3ASE-840H-D500-S	1094,00
600	4000K	On/Off	Medium	3560lm/28W	9,5	BA3AWE-840M-D600-W	BA3ASE-840M-D600-S	1400,00
600	4000K	On/Off	High	5230lm/42W	9,5	BA3AWE-840H-D600-W	BA3ASE-840H-D600-S	1400,00
800	4000K	On/Off	Medium	5360lm/44W	15,8	BA3AWE-840M-D800-W	BA3ASE-840M-D800-S	2589,00
800	4000K	On/Off	High	6490lm/55W	15,8	BA3AWE-840H-D800-W	BA3ASE-840H-D800-S	2589,00

A3 Opal Diffuser | Direct

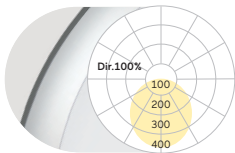

D mm	Colour Temperature	Control	Power	Lumen/Watt	Weight kg	Code Snow White	Code Radiant Silver	CHF
300	4000K	On/Off	Medium	810lm/8W	2,9	BA3OWE-840M-D300-W	BA3OSE-840M-D300-S	646,00
300	4000K	On/Off	High	1400lm/13W	2,9	BA3OWE-840H-D300-W	BA3OSE-840H-D300-S	646,00
400	4000K	On/Off	Medium	1500lm/14W	4,7	BA3OWE-840M-D400-W	BA3OSE-840M-D400-S	832,00
400	4000K	On/Off	High	2410lm/21W	4,7	BA3OWE-840H-D400-W	BA3OSE-840H-D400-S	832,00
500	4000K	On/Off	Medium	2390lm/21W	6,8	BA3OWE-840M-D500-W	BA3OSE-840M-D500-S	1024,00
500	4000K	On/Off	High	4040lm/35W	6,8	BA3OWE-840H-D500-W	BA3OSE-840H-D500-S	1024,00
600	4000K	On/Off	Medium	3650lm/28W	9,5	BA3OWE-840M-D600-W	BA3OSE-840M-D600-S	1252,00
600	4000K	On/Off	High	5330lm/42W	9,5	BA3OWE-840H-D600-W	BA3OSE-840H-D600-S	1252,00
800	4000K	On/Off	Medium	5510lm/44W	15,8	BA3OWE-840M-D800-W	BA3OSE-840M-D800-S	2449,00
800	4000K	On/Off	High	6660lm/55W	15,8	BA3OWE-840H-D800-W	BA3OSE-840H-D800-S	2449,00

A4 Microprismatic | Direct

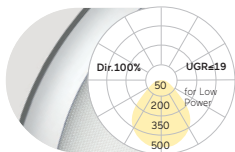

D mm	Colour Temperature	Control	Power	Lumen/Watt	Weight kg	Code Snow White	Code Radiant Silver	CHF
300	4000K	On/Off	Low	880lm/8W	3,5	BA4AWE-840E-D300-W	BA4ASE-840E-D300-S	699,00
300	4000K	On/Off	Medium	1730lm/14W	3,5	BA4AWE-840M-D300-W	BA4ASE-840M-D300-S	699,00
400	4000K	On/Off	Low	1740lm/13W	4,5	BA4AWE-840E-D400-W	BA4ASE-840E-D400-S	919,00
400	4000K	On/Off	Medium	3580lm/29W	4,5	BA4AWE-840M-D400-W	BA4ASE-840M-D400-S	919,00
500	4000K	On/Off	Low	2480lm/18W	6,5	BA4AWE-840E-D500-W	BA4ASE-840E-D500-S	1147,00
500	4000K	On/Off	Medium	4860lm/35W	6,5	BA4AWE-840M-D500-W	BA4ASE-840M-D500-S	1147,00
600	4000K	On/Off	Low	3860lm/28W	10,0	BA4AWE-840E-D600-W	BA4ASE-840E-D600-S	1470,00
600	4000K	On/Off	Medium	7250lm/52W	10,0	BA4AWE-840M-D600-W	BA4ASE-840M-D600-S	1470,00
900	4000K	On/Off	Low	6800lm/59W	15,0	BA4AWE-840E-D900-W	BA4ASE-840E-D900-S	2676,00
900	4000K	On/Off	Medium	11490lm/106W	15,0	BA4AWE-840M-D900-W	BA4ASE-840M-D900-S	2676,00
1200	4000K	On/Off	Low	11890lm/107W	24,0	BA4AWE-840E-D1200-W	BA4ASE-840E-D1200-S	3674,00
1200	4000K	On/Off	Medium	20110lm/195W	24,0	BA4AWE-840M-D1200-W	BA4ASE-840M-D1200-S	3674,00

A4 Opal Diffuser | Direct

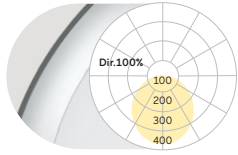

D mm	Colour Temperature	Control	Power	Lumen/Watt	Weight kg	Code Snow White	Code Radiant Silver	CHF
300	4000K	On/Off	Low	910lm/8W	3,5	BA4OWE-840E-D300-W	BA4OSE-840E-D300-S	664,00
300	4000K	On/Off	Medium	1780lm/14W	3,5	BA4OWE-840M-D300-W	BA4OSE-840M-D300-S	664,00
400	4000K	On/Off	Low	1790lm/13W	4,5	BA4OWE-840E-D400-W	BA4OSE-840E-D400-S	867,00
400	4000K	On/Off	Medium	3690lm/29W	4,5	BA4OWE-840M-D400-W	BA4OSE-840M-D400-S	867,00
500	4000K	On/Off	Low	2550lm/18W	6,5	BA4OWE-840E-D500-W	BA4OSE-840E-D500-S	1077,00
500	4000K	On/Off	Medium	5010lm/35W	6,5	BA4OWE-840M-D500-W	BA4OSE-840M-D500-S	1077,00
600	4000K	On/Off	Low	3980lm/28W	10,0	BA4OWE-840E-D600-W	BA4OSE-840E-D600-S	1322,00
600	4000K	On/Off	Medium	7470lm/52W	10,0	BA4OWE-840M-D600-W	BA4OSE-840M-D600-S	1322,00
900	4000K	On/Off	Low	7000lm/59W	15,0	BA4OWE-840E-D900-W	BA4OSE-840E-D900-S	2536,00
900	4000K	On/Off	Medium	11830lm/106W	15,0	BA4OWE-840M-D900-W	BA4OSE-840M-D900-S	2536,00
1200	4000K	On/Off	Low	12250lm/107W	24,0	BA4OWE-840E-D1200-W	BA4OSE-840E-D1200-S	3492,00
1200	4000K	On/Off	Medium	20700lm/195W	24,0	BA4OWE-840M-D1200-W	BA4OSE-840M-D1200-S	3492,00

Surcharges

Surface / Reflector Finish

Uni-Colour

Code	Finish	CHF
W...W:	Snow White / Snow White	✓
V...V:	Ivory White / Ivory White	✓
S...S:	Radiant Silver / Radiant Silver	✓
U...U:	Urban Graphite / Urban Graphite	✓
B...B:	Jet Black / Jet Black	✓
H...H:	Anodic Champ. / Anodic Champ.	+5%
K...K:	Satin Copper / Satin Copper	+15%

Surface / Reflector Finish

Dual Colours

Code	Finish	CHF
W...G:	Snow White / Satin Gold	+15%
W...K:	Snow White / Satin Copper	+15%
W...B:	Snow White / Jet Black	+15%
H...B:	Anodic Champagne / Jet Black	+15%
B...G:	Jet Black / Satin Gold	+15%
B...W:	Jet Black / Snow White	+15%

Control Gear

Code	D300-D600	D900-D1200	CHF
E: On/Off	✓	✓	
L: DALI	+86,00	+172,00	
H: Touch-Dim	+86,00	+172,00	
C: Casambi*	+261,00	+261,00	
6: DALI DT6 for TW	+172,00	+336,00	
8: DALI DT8 for TW	+172,00	+336,00	

*Only in combination with DALI. Please add to dimming price.

Colour Rendering

Code	CHF
8: CRI>80	✓
9: CRI>90	+5%
F: Full Spectrum	+15%

Colour Temperature

Code	CHF
22: 2200K	+5%
27: 2700K	+5%
30: 3000K	✓
35: 3500K	+5%
40: 4000K	✓
65: 6500K	+5%
TW: Tunable White 2700-6500K* [D400-D1200]	+30%

*Only in combination with DT6, DT8 or Casambi control. Please add additional control price.

Additional Options

Option	CHF
Radar Sensor	+209,00
Multisensor [D400-D1200]	+261,00
Emergency Module [DALI, Autotest, incl. 3H Battery] [D400-D1200]	+366,00

✓ standard / no extra charge 🟡 on request ✗ not available

Basic Déco X3 | Surface

catalogue page 348



Microprismatic | Direct-Indirect

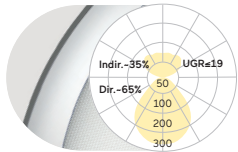

D mm	Colour Temperature	Control	Power	Lumen/Watt	Weight kg	Code Snow White	Code Radiant Silver	CHF
300	4000K	On/Off	Medium	1480lm/13W	2,3	BX3AWE-840M-D300-W	BX3ASE-840M-D300-S	821,00
300	4000K	On/Off	High	2530lm/23W	2,3	BX3AWE-840H-D300-W	BX3ASE-840H-D300-S	821,00
400	4000K	On/Off	Medium	2370lm/20W	4,0	BX3AWE-840M-D400-W	BX3ASE-840M-D400-S	1042,00
400	4000K	On/Off	High	3750lm/31W	4,0	BX3AWE-840H-D400-W	BX3ASE-840H-D400-S	1042,00
500	4000K	On/Off	Medium	3500lm/29W	5,6	BX3AWE-840M-D500-W	BX3ASE-840M-D500-S	1269,00
500	4000K	On/Off	High	5810lm/48W	5,6	BX3AWE-840H-D500-W	BX3ASE-840H-D500-S	1269,00
600	4000K	On/Off	Medium	5380lm/43W	7,5	BX3AWE-840M-D600-W	BX3ASE-840M-D600-S	1593,00
600	4000K	On/Off	High	7750lm/63W	7,5	BX3AWE-840H-D600-W	BX3ASE-840H-D600-S	1593,00
800	4000K	On/Off	Medium	7830lm/63W	12,2	BX3AWE-840M-D800-W	BX3ASE-840M-D800-S	2799,00
800	4000K	On/Off	High	9940lm/82W	12,2	BX3AWE-840H-D800-W	BX3ASE-840H-D800-S	2799,00

Opal Diffuser | Direct-Indirect

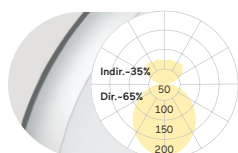

D mm	Colour Temperature	Control	Power	Lumen/Watt	Weight kg	Code Snow White	Code Radiant Silver	CHF
300	4000K	On/Off	Medium	1460lm/13W	2,3	BX3OWE-840M-D300-W	BX3OSE-840M-D300-S	786,00
300	4000K	On/Off	High	2500lm/23W	2,3	BX3OWE-840H-D300-W	BX3OSE-840H-D300-S	786,00
400	4000K	On/Off	Medium	2370lm/20W	4,0	BX3OWE-840M-D400-W	BX3OSE-840M-D400-S	989,00
400	4000K	On/Off	High	3750lm/31W	4,0	BX3OWE-840H-D400-W	BX3OSE-840H-D400-S	989,00
500	4000K	On/Off	Medium	3520lm/29W	5,6	BX3OWE-840M-D500-W	BX3OSE-840M-D500-S	1199,00
500	4000K	On/Off	High	5870lm/48W	5,6	BX3OWE-840H-D500-W	BX3OSE-840H-D500-S	1199,00
600	4000K	On/Off	Medium	5470lm/43W	7,5	BX3OWE-840M-D600-W	BX3OSE-840M-D600-S	1444,00
600	4000K	On/Off	High	7850lm/63W	7,5	BX3OWE-840H-D600-W	BX3OSE-840H-D600-S	1444,00
800	4000K	On/Off	Medium	7980lm/63W	12,2	BX3OWE-840M-D800-W	BX3OSE-840M-D800-S	2659,00
800	4000K	On/Off	High	10110lm/82W	12,2	BX3OWE-840H-D800-W	BX3OSE-840H-D800-S	2659,00

Surcharges			
Surface / Reflector Finish		CHF	
Uni-Colours			
W...W: Snow White / Snow White	✓		
V...V: Ivory White / Ivory White	✓		
S...S: Radiant Silver / Radiant Silver	✓		
U...U: Urban Graphite / Urban Graphite	✓		
B...B: Jet Black / Jet Black	✓		
H...H: Anodic Champ. / Anodic Champ.	+5%		
K...K: Satin Copper / Satin Copper	+15%		
Surface / Reflector Finish		CHF	
Dual Colours			
W...G: Snow White / Satin Gold	+15%		
W...K: Snow White / Satin Copper	+15%		
W...B: Snow White / Jet Black	+15%		
H...B: Anodic Champagne / Jet Black	+15%		
B...G: Jet Black / Satin Gold	+15%		
B...W: Jet Black / Snow White	+15%		
Control Gear		CHF	CHF
D300-D600			
D800			
E: On/Off	✓		
L: DALI	+86,00	+172,00	
H: Touch-Dim	+86,00	+172,00	
C: Casambi*	+261,00	+261,00	
[D400-D800]			
6: DALI DT6 for TW	+172,00	+343,00	
8: DALI DT8 for TW	+172,00	+343,00	
*Only in combination with DALI. Please add to dimming price.			
Colour Rendering		CHF	
8: CRI>80	✓		
9: CRI>90	+5%		
F: Full Spectrum	+15%		
Colour Temperature		CHF	
22: 2200K	+5%		
27: 2700K	+5%		
30: 3000K	✓		
35: 3500K	+5%		
40: 4000K	✓		
65: 6500K	+5%		
TW: Tunable White 2700-6500K*	+30%		
[D400-D800]			
*Only in combination with DT6, DT8 or Casambi control. Please add additional control price.			
Additional Options		CHF	
Radar Sensor	+209,00		
Multisensor [D400-D800]	+261,00		
Emergency Module [DALI, Autotest, incl. 3H Battery]	+366,00		
[D400-D800]			

✓ standard / no extra charge
🕒 on request
✗ not available

Basic Déco Z3 | Surface

catalogue page 350

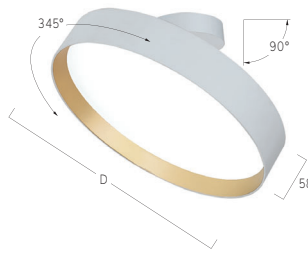

Microprismatic | Direct

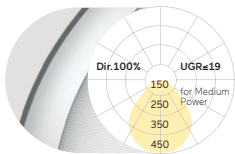

D mm	Colour Temperature	Control	Power	Lumen/Watt	Weight kg	Code Snow White	Code Radiant Silver	CHF
300	4000K	On/Off	Medium	830lm/8W	3,2	BZ3AWE-840M-D300-W	BZ3ASE-840M-D300-S	926,00
300	4000K	On/Off	High	1430lm/13W	3,2	BZ3AWE-840H-D300-W	BZ3ASE-840H-D300-S	926,00

Opal Diffuser | Direct

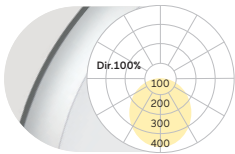

D mm	Colour Temperature	Control	Power	Lumen/Watt	Weight kg	Code Snow White	Code Radiant Silver	CHF
300	4000K	On/Off	Medium	810lm/8W	3,2	BZ3OWE-840M-D300-W	BZ3OSE-840M-D300-S	909,00
300	4000K	On/Off	High	1400lm/13W	3,2	BZ3OWE-840H-D300-W	BZ3OSE-840H-D300-S	909,00

Surcharges			
Surface / Reflector Finish		CHF	
Uni-Colours			
W...W: Snow White / Snow White	✓		
V...V: Ivory White / Ivory White	✓		
S...S: Radiant Silver / Radiant Silver	✓		
U...U: Urban Graphite / Urban Graphite	✓		
B...B: Jet Black / Jet Black	✓		
H...H: Anodic Champ. / Anodic Champ.	+5%		
K...K: Satin Copper / Satin Copper	+15%		
Surface / Reflector Finish		CHF	
Dual Colours			
W...G: Snow White / Satin Gold	+15%		
W...K: Snow White / Satin Copper	+15%		
W...B: Snow White / Jet Black	+15%		
H...B: Anodic Champagne / Jet Black	+15%		
B...G: Jet Black / Satin Gold	+15%		
B...W: Jet Black / Snow White	+15%		
Control Gear		CHF	CHF
D300-D600			
D800			
E: On/Off	✓		
L: DALI	+86,00	+172,00	
H: Touch-Dim	+86,00	+172,00	
C: Casambi	+261,00	+261,00	
*Only in combination with DALI. Please add to dimming price.			
Colour Rendering		CHF	
8: CRI>80	✓		
9: CRI>90	+5%		
F: Full Spectrum	+15%		
Colour Temperature		CHF	
22: 2200K	+5%		
27: 2700K	+5%		
30: 3000K	✓		
35: 3500K	+5%		
40: 4000K	✓		
65: 6500K	+5%		

✓ standard / no extra charge
🕒 on request
✗ not available

Basic Max A1 | Surface

catalogue page 352



Microprismatic | Direct

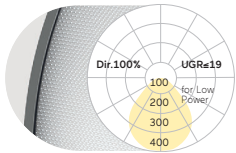

D mm	Colour Temperature	Control	Power	Lumen/Watt	Weight kg	Code Snow White	Code Radiant Silver	CHF
200	4000K	On/Off	Low	450lm/5W	1,1	BA1AWE-840E-D200	BA1ASE-840E-D200	394,00
200	4000K	On/Off	Medium	1110lm/10W	1,1	BA1AWE-840M-D200	BA1ASE-840M-D200	394,00
300	4000K	On/Off	Low	880lm/8W	2,2	BA1AWE-840E-D300	BA1ASE-840E-D300	550,00
300	4000K	On/Off	Medium	1730lm/14W	2,2	BA1AWE-840M-D300	BA1ASE-840M-D300	550,00
400	4000K	On/Off	Low	1740lm/13W	3,5	BA1AWE-840E-D400	BA1ASE-840E-D400	783,00
400	4000K	On/Off	Medium	3580lm/29W	3,5	BA1AWE-840M-D400	BA1ASE-840M-D400	783,00
500	4000K	On/Off	Low	2480lm/18W	5,7	BA1AWE-840E-D500	BA1ASE-840E-D500	965,00
500	4000K	On/Off	Medium	4860lm/35W	5,7	BA1AWE-840M-D500	BA1ASE-840M-D500	965,00
600	4000K	On/Off	Low	3860lm/28W	8,9	BA1AWE-840E-D600	BA1ASE-840E-D600	1269,00
600	4000K	On/Off	Medium	7250lm/52W	8,9	BA1AWE-840M-D600	BA1ASE-840M-D600	1269,00
900	4000K	On/Off	Low	6800lm/59W	12,6	BA1AWE-840E-D900	BA1ASE-840E-D900	2328,00
900	4000K	On/Off	Medium	11490lm/106W	12,6	BA1AWE-840M-D900	BA1ASE-840M-D900	2328,00
1200	4000K	On/Off	Low	11890lm/107W	21,9	BA1AWE-840E-D1200	BA1ASE-840E-D1200	3758,00
1200	4000K	On/Off	Medium	20110lm/195W	21,9	BA1AWE-840M-D1200	BA1ASE-840M-D1200	3758,00

Opal Diffuser | Direct

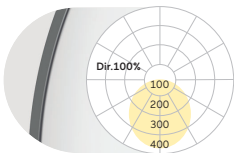

D mm	Colour Temperature	Control	Power	Lumen/Watt	Weight kg	Code Snow White	Code Radiant Silver	CHF
200	4000K	On/Off	Low	470lm/5W	1,1	BA1OWE-840E-D200	BA1OSE-840E-D200	347,00
200	4000K	On/Off	Medium	1160lm/10W	1,1	BA1OWE-840M-D200	BA1OSE-840M-D200	347,00
300	4000K	On/Off	Low	910lm/8W	2,2	BA1OWE-840E-D300	BA1OSE-840E-D300	476,00
300	4000K	On/Off	Medium	1780lm/14W	2,2	BA1OWE-840M-D300	BA1OSE-840M-D300	476,00
400	4000K	On/Off	Low	1790lm/13W	3,5	BA1OWE-840E-D400	BA1OSE-840E-D400	686,00
400	4000K	On/Off	Medium	3690lm/29W	3,5	BA1OWE-840M-D400	BA1OSE-840M-D400	686,00
500	4000K	On/Off	Low	2550lm/18W	5,7	BA1OWE-840E-D500	BA1OSE-840E-D500	832,00
500	4000K	On/Off	Medium	5010lm/35W	5,7	BA1OWE-840M-D500	BA1OSE-840M-D500	832,00
600	4000K	On/Off	Low	3980lm/28W	8,9	BA1OWE-840E-D600	BA1OSE-840E-D600	1122,00
600	4000K	On/Off	Medium	7470lm/52W	8,9	BA1OWE-840M-D600	BA1OSE-840M-D600	1122,00
900	4000K	On/Off	Low	7000lm/59W	12,6	BA1OWE-840E-D900	BA1OSE-840E-D900	2151,00
900	4000K	On/Off	Medium	11830lm/106W	12,6	BA1OWE-840M-D900	BA1OSE-840M-D900	2151,00
1200	4000K	On/Off	Low	12250lm/107W	21,9	BA1OWE-840E-D1200	BA1OSE-840E-D1200	3563,00
1200	4000K	On/Off	Medium	20700lm/195W	21,9	BA1OWE-840M-D1200	BA1OSE-840M-D1200	3563,00

Surcharges

Surface Finish	CHF	Control Gear	CHF	Colour Rendering	CHF	Colour Temperature	CHF	Additional Options	CHF
W: Snow White	✓	E: On/Off	✓	8: CRI>80	✓	22: 2200K	+5%	Radar Sensor	+209,00
V: Ivory White	✓	L: DALI	+86,00	9: CRI>90	+5%	27: 2700K	+5%	Emergency Module [DALI, Autotest, incl. 3H Battery]	+366,00
S: Radiant Silver	✓	H: Touch-Dim	+86,00	F: Full Spectrum	+15%	30: 3000K	✓	[D400-D1200]	
U: Urban Graphite	✓	C: Casambi* [D300-D1200]	+261,00			35: 3500K	+5%		
B: Jet Black	✓	6: DALI DT6 for TW	+172,00			40: 4000K	✓		
H: Anodic Champagne	+10%	8: DALI DT8 for TW	+172,00			65: 6500K	+5%		
K: Satin Copper	+15%		+343,00			TW: Tunable White 2700-6500K* [D400-D1200]	+30%		
R: Special RAL/NCS Colours	⚡	*Only in combination with DALI. Please add to dimming price.							

✓ standard / no extra charge ⚡ on request ✗ not available

*Only in combination with DT6, DT8 or Casambi control. Please add additional control price.

Basic Max Y1/X1 | Surface

catalogue page 354



Microprismatic | Direct-Indirect

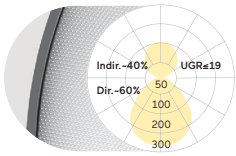

D mm	Colour Temperature	Control	Power	Lumen/Watt	Weight kg	Code Snow White	Code Radiant Silver	CHF
300	4000K	On/Off	Low	1440lm/12W	2,2	BX1AWE-840E-D300	BX1ASE-840E-D300	681,00
300	4000K	On/Off	Medium	2810lm/21W	2,2	BX1AWE-840M-D300	BX1ASE-840M-D300	681,00
400	4000K	On/Off	Low	2800lm/19W	3,6	BX1AWE-840E-D400	BX1ASE-840E-D400	874,00
400	4000K	On/Off	Medium	5740lm/40W	3,6	BX1AWE-840M-D400	BX1ASE-840M-D400	874,00
500	4000K	On/Off	Low	3970lm/29W	5,4	BX1AWE-840E-D500	BX1ASE-840E-D500	1152,00
500	4000K	On/Off	Medium	7760lm/53W	5,4	BX1AWE-840M-D500	BX1ASE-840M-D500	1152,00
600	4000K	On/Off	Low	8370lm/55W	7,8	BX1AWE-840E-D600	BX1ASE-840E-D600	1369,00
600	4000K	On/Off	Medium	12900lm/87W	7,8	BX1AWE-840M-D600	BX1ASE-840M-D600	1369,00
900	4000K	On/Off	Low	11330lm/88W	14,8	BX1AWE-840E-D900	BX1ASE-840E-D900	2468,00
900	4000K	On/Off	Medium	17110lm/144W	14,8	BX1AWE-840M-D900	BX1ASE-840M-D900	2468,00
1200	4000K	On/Off	Low	18140lm/143W	25,2	BX1AWE-840E-D1200	BX1ASE-840E-D1200	4118,00
1200	4000K	On/Off	Medium	28870lm/251W	25,2	BX1AWE-840M-D1200	BX1ASE-840M-D1200	4118,00

Microprismatic | Direct

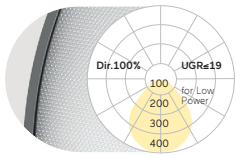

D mm	Colour Temperature	Control	Power	Lumen/Watt	Weight kg	Code Snow White	Code Radiant Silver	CHF
300	4000K	On/Off	Low	880lm/8W	2,0	BY1AWE-840E-D300	BY1ASE-840E-D300	636,00
300	4000K	On/Off	Medium	1730lm/14W	2,0	BY1AWE-840M-D300	BY1ASE-840M-D300	636,00
400	4000K	On/Off	Low	1740lm/13W	3,4	BY1AWE-840E-D400	BY1ASE-840E-D400	868,00
400	4000K	On/Off	Medium	3580lm/29W	3,4	BY1AWE-840M-D400	BY1ASE-840M-D400	868,00
500	4000K	On/Off	Low	2480lm/18W	5,2	BY1AWE-840E-D500	BY1ASE-840E-D500	1050,00
500	4000K	On/Off	Medium	4860lm/35W	5,2	BY1AWE-840M-D500	BY1ASE-840M-D500	1050,00
600	4000K	On/Off	Low	3860lm/28W	7,4	BY1AWE-840E-D600	BY1ASE-840E-D600	1355,00
600	4000K	On/Off	Medium	7250lm/52W	7,4	BY1AWE-840M-D600	BY1ASE-840M-D600	1355,00
900	4000K	On/Off	Low	6800lm/59W	14,0	BY1AWE-840E-D900	BY1ASE-840E-D900	2414,00
900	4000K	On/Off	Medium	11490lm/106W	14,0	BY1AWE-840M-D900	BY1ASE-840M-D900	2414,00
1200	4000K	On/Off	Low	11890lm/107W	20,0	BY1AWE-840E-D1200	BY1ASE-840E-D1200	3843,00
1200	4000K	On/Off	Medium	20110lm/195W	20,0	BY1AWE-840M-D1200	BY1ASE-840M-D1200	3843,00

Opal Diffuser | Direct-Indirect

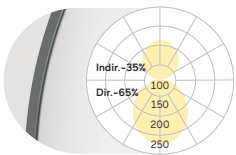

D mm	Colour Temperature	Control	Power	Lumen/Watt	Weight kg	Code Snow White	Code Radiant Silver	CHF
300	4000K	On/Off	Low	1470lm/12W	2,2	BX1OWE-840E-D300	BX1OSE-840E-D300	648,00
300	4000K	On/Off	Medium	2860lm/21W	2,2	BX1OWE-840M-D300	BX1OSE-840M-D300	648,00
400	4000K	On/Off	Low	2850lm/19W	3,6	BX1OWE-840E-D400	BX1OSE-840E-D400	809,00
400	4000K	On/Off	Medium	5850lm/40W	3,6	BX1OWE-840M-D400	BX1OSE-840M-D400	809,00
500	4000K	On/Off	Low	4040lm/29W	5,4	BX1OWE-840E-D500	BX1OSE-840E-D500	1045,00
500	4000K	On/Off	Medium	7910lm/53W	5,4	BX1OWE-840M-D500	BX1OSE-840M-D500	1045,00
600	4000K	On/Off	Low	8490lm/55W	7,8	BX1OWE-840E-D600	BX1OSE-840E-D600	1285,00
600	4000K	On/Off	Medium	13120lm/87W	7,8	BX1OWE-840M-D600	BX1OSE-840M-D600	1285,00
900	4000K	On/Off	Low	11530lm/88W	14,8	BX1OWE-840E-D900	BX1OSE-840E-D900	2331,00
900	4000K	On/Off	Medium	17450lm/144W	14,8	BX1OWE-840M-D900	BX1OSE-840M-D900	2331,00
1200	4000K	On/Off	Low	18500lm/143W	25,2	BX1OWE-840E-D1200	BX1OSE-840E-D1200	3931,00
1200	4000K	On/Off	Medium	29460lm/251W	25,2	BX1OWE-840M-D1200	BX1OSE-840M-D1200	3931,00

Opal Diffuser | Direct

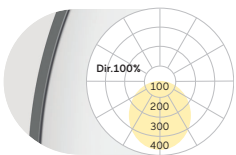

D mm	Colour Temperature	Control	Power	Lumen/Watt	Weight kg	Code Snow White	Code Radiant Silver	CHF
300	4000K	On/Off	Low	910lm/8W	2,0	BY1OWE-840E-D300	BY1OSE-840E-D300	562,00
300	4000K	On/Off	Medium	1780lm/14W	2,0	BY1OWE-840M-D300	BY1OSE-840M-D300	562,00
400	4000K	On/Off	Low	1790lm/13W	3,4	BY1OWE-840E-D400	BY1OSE-840E-D400	772,00
400	4000K	On/Off	Medium	3690lm/29W	3,4	BY1OWE-840M-D400	BY1OSE-840M-D400	772,00
500	4000K	On/Off	Low	2550lm/18W	5,2	BY1OWE-840E-D500	BY1OSE-840E-D500	917,00
500	4000K	On/Off	Medium	5010lm/35W	5,2	BY1OWE-840M-D500	BY1OSE-840M-D500	917,00
600	4000K	On/Off	Low	3980lm/28W	7,4	BY1OWE-840E-D600	BY1OSE-840E-D600	1208,00
600	4000K	On/Off	Medium	7470lm/52W	7,4	BY1OWE-840M-D600	BY1OSE-840M-D600	1208,00
900	4000K	On/Off	Low	7000lm/59W	14,0	BY1OWE-840E-D900	BY1OSE-840E-D900	2237,00
900	4000K	On/Off	Medium	11830lm/106W	14,0	BY1OWE-840M-D900	BY1OSE-840M-D900	2237,00
1200	4000K	On/Off	Low	12250lm/107W	20,0	BY1OWE-840E-D1200	BY1OSE-840E-D1200	3649,00
1200	4000K	On/Off	Medium	20700lm/195W	20,0	BY1OWE-840M-D1200	BY1OSE-840M-D1200	3649,00

Surcharges

Surface Finish	CHF	Control Gear	CHF	CHF	Colour Temperature	CHF	Colour Rendering	CHF
W: Snow White	✓	E: On/Off	D300-D600	D900-D1200	22: 2200K	+5%	8: CRI>80	✓
V: Ivory White	✓	L: DALI	+86,00	+172,00	27: 2700K	+5%	9: CRI>90	+5%
S: Radiant Silver	✓	H: Touch-Dim	+86,00	+172,00	30: 3000K	✓	F: Full Spectrum	+15%
U: Urban Graphite	✓	C: Casambi*	+261,00	+261,00	35: 3500K	+5%		
B: Jet Black	✓	6: DALI DT6 for TW	+172,00	+343,00	40: 4000K	✓	Additional Options	CHF
H: Anodic Champagne	+10%	8: DALI DT8 for TW	+172,00	+343,00	65: 6500K	+5%	Radar Sensor	+209,00
K: Satin Copper	+15%				TW: Tunable White 2700-6500K* [D400-D1200]	+30%	Emergency Module [DALI, Autotest, incl. 3H Battery] [D400-D2000]	+366,00
R: Special RAL/NCS Colours	🔗							

*Only in combination with DALI. Please add to dimming price.

*Only in combination with DT6, DT8 or Casambi control. Please add additional control price.

✓ standard / no extra charge 🔗 on request ✗ not available

Basic Visio Y9/X9 | Surface

catalogue page 356



Microprismatic | Direct-Indirect

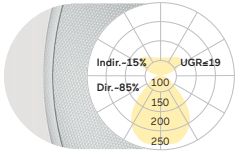

D mm	Colour Temperature	Control	Power	Lumen/Watt	Weight kg	Code Snow White	Code Urban Graphite	CHF
300	4000K	On/Off	Medium	760lm/6W	3,8	BX9AWE-840M-D300	BX9AUE-840M-D300	856,00
300	4000K	On/Off	High	1200lm/10W	3,8	BX9AWE-840H-D300	BX9AUE-840H-D300	856,00
400	4000K	On/Off	Medium	1770lm/14W	5,0	BX9AWE-840M-D400	BX9AUE-840M-D400	1066,00
400	4000K	On/Off	High	3090lm/23W	5,0	BX9AWE-840H-D400	BX9AUE-840H-D400	1066,00
500	4000K	On/Off	Medium	2840lm/21W	6,2	BX9AWE-840M-D500	BX9AUE-840M-D500	1364,00
500	4000K	On/Off	High	5230lm/38W	6,2	BX9AWE-840H-D500	BX9AUE-840H-D500	1364,00
610	4000K	On/Off	Medium	3830lm/28W	7,5	BX9AWE-840M-D610	BX9AUE-840M-D610	1871,00
610	4000K	On/Off	High	7100lm/52W	7,5	BX9AWE-840H-D610	BX9AUE-840H-D610	1871,00

Microprismatic | Direct

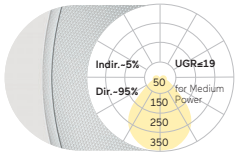

D mm	Colour Temperature	Control	Power	Lumen/Watt	Weight kg	Code Snow White	Code Urban Graphite	CHF
300	4000K	On/Off	Medium	630lm/5W	3,5	BY9AWE-840M-D300	BY9AUE-840M-D300	769,00
300	4000K	On/Off	High	1000lm/9W	3,5	BY9AWE-840H-D300	BY9AUE-840H-D300	769,00
400	4000K	On/Off	Medium	1630lm/13W	4,7	BY9AWE-840M-D400	BY9AUE-840M-D400	961,00
400	4000K	On/Off	High	2840lm/22W	4,7	BY9AWE-840H-D400	BY9AUE-840H-D400	961,00
500	4000K	On/Off	Medium	2470lm/19W	6,0	BY9AWE-840M-D500	BY9AUE-840M-D500	1206,00
500	4000K	On/Off	High	4560lm/34W	6,0	BY9AWE-840H-D500	BY9AUE-840H-D500	1206,00
610	4000K	On/Off	Medium	3340lm/25W	7,1	BY9AWE-840M-D610	BY9AUE-840M-D610	1644,00
610	4000K	On/Off	High	6200lm/46W	7,1	BY9AWE-840H-D610	BY9AUE-840H-D610	1644,00

Opal Diffuser | Direct-Indirect

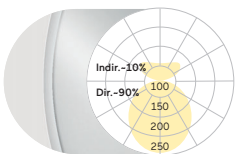

D mm	Colour Temperature	Control	Power	Lumen/Watt	Weight kg	Code Snow White	Code Urban Graphite	CHF
300	4000K	On/Off	Medium	800lm/6W	3,8	BX9OWE-840M-D300	BX9OUE-840M-D300	769,00
300	4000K	On/Off	High	1260lm/10W	3,8	BX9OWE-840H-D300	BX9OUE-840H-D300	769,00
400	4000K	On/Off	Medium	1870lm/14W	5,0	BX9OWE-840M-D400	BX9OUE-840M-D400	961,00
400	4000K	On/Off	High	3270lm/23W	5,0	BX9OWE-840H-D400	BX9OUE-840H-D400	961,00
500	4000K	On/Off	Medium	2990lm/21W	6,2	BX9OWE-840M-D500	BX9OUE-840M-D500	1224,00
500	4000K	On/Off	High	5500lm/38W	6,2	BX9OWE-840H-D500	BX9OUE-840H-D500	1224,00
610	4000K	On/Off	Medium	4040lm/28W	7,5	BX9OWE-840M-D610	BX9OUE-840M-D610	1609,00
610	4000K	On/Off	High	7470lm/52W	7,5	BX9OWE-840H-D610	BX9OUE-840H-D610	1609,00

Opal Diffuser | Direct

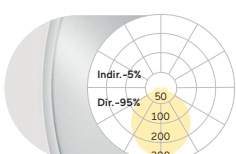

D mm	Colour Temperature	Control	Power	Lumen/Watt	Weight kg	Code Snow White	Code Urban Graphite	CHF
300	4000K	On/Off	Medium	670lm/5W	3,5	BY9OWE-840M-D300	BY9OUE-840M-D300	681,00
300	4000K	On/Off	High	1060lm/9W	3,5	BY9OWE-840H-D300	BY9OUE-840H-D300	681,00
400	4000K	On/Off	Medium	1730lm/13W	4,7	BY9OWE-840M-D400	BY9OUE-840M-D400	856,00
400	4000K	On/Off	High	3020lm/22W	4,7	BY9OWE-840H-D400	BY9OUE-840H-D400	856,00
500	4000K	On/Off	Medium	2620lm/19W	6,0	BY9OWE-840M-D500	BY9OUE-840M-D500	1066,00
500	4000K	On/Off	High	4830lm/34W	6,0	BY9OWE-840H-D500	BY9OUE-840H-D500	1066,00
610	4000K	On/Off	Medium	3550lm/25W	7,1	BY9OWE-840M-D610	BY9OUE-840M-D610	1381,00
610	4000K	On/Off	High	6570lm/46W	7,1	BY9OWE-840H-D610	BY9OUE-840H-D610	1381,00

Surface Finish		CHF	Control Gear		CHF	Colour Rendering		CHF	Colour Temperature		CHF
W: Snow White	✓		E: On/Off	✓		8: CRI>80	✓		22: 2200K	+5%	
U: Urban Graphite	✓		L: DALI	+86,00		9: CRI>90	+5%		27: 2700K	+5%	
R: Special RAL/NCS Colours	ⓘ		H: Touch-Dim	+86,00		F: Full Spectrum	+15%		30: 3000K	✓	
			C: Casambi	+261,00					35: 3500K	+5%	
			6: DALI DT6 for TW	+172,00					40: 4000K	✓	
			8: DALI DT8 for TW	+172,00					65: 6500K	+5%	
									TW: Tunable White 2700-6500K* [D400-D610]	+30%	

*Only in combination with DT6, DT8 or Casambi control. Please add additional control price.

✓ standard / no extra charge ⓘ on request ✗ not available

Beam Me Up (Flat) Y3/X3 | Surface

catalogue page 358



Microprismatic | Direct-Indirect

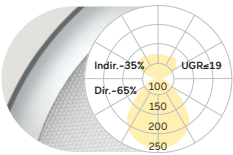

D mm	Colour TeMxerature	Control	Power	Lumen/Watt	Weight kg	Code Snow White	Code Satin Silver	CHF
450	4000K	On/Off	Medium	2240lm/18W	5,5	MX3AWE-840M-D450-W	MX3AAE-840M-D450-A	1645,00
450	4000K	On/Off	High	3870lm/31W	5,5	MX3AWE-840H-D450-W	MX3AAE-840H-D450-A	1645,00
650	4000K	On/Off	Medium	5020lm/40W	7,5	MX3AWE-840M-D650-W	MX3AAE-840M-D650-A	2538,00
650	4000K	On/Off	High	7720lm/63W	7,5	MX3AWE-840H-D650-W	MX3AAE-840H-D650-A	2538,00
850	4000K	On/Off	Medium	7490lm/60W	11,4	MX3AWE-840M-D850-W	MX3AAE-840M-D850-A	3798,00
850	4000K	On/Off	High	10240lm/81W	11,4	MX3AWE-840H-D850-W	MX3AAE-840H-D850-A	3798,00

Microprismatic | Direct

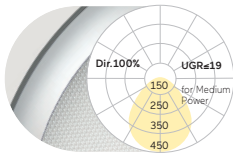

D mm	Colour Temperature	Control	Power	Lumen/Watt	Weight kg	Code Snow White	Code Satin Silver	CHF
450	4000K	On/Off	Medium	1450lm/12W	5,5	MY3AWE-840M-D450-W	MY3AAE-840M-D450-A	1488,00
450	4000K	On/Off	High	2510lm/21W	5,5	MY3AWE-840H-D450-W	MY3AAE-840H-D450-A	1488,00
650	4000K	On/Off	Medium	3200lm/25W	7,0	MY3AWE-840M-D650-W	MY3AAE-840M-D650-A	2345,00
650	4000K	On/Off	High	5200lm/42W	7,0	MY3AWE-840H-D650-W	MY3AAE-840H-D650-A	2345,00
850	4000K	On/Off	Medium	5020lm/40W	11,4	MY3AWE-840M-D850-W	MY3AAE-840M-D850-A	3588,00
850	4000K	On/Off	High	6790lm/54W	11,4	MY3AWE-840H-D850-W	MY3AAE-840H-D850-A	3588,00

Opal Diffuser | Direct-Indirect

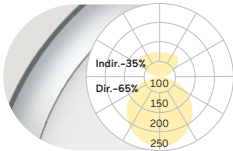

D mm	Colour TeMxerature	Control	Power	Lumen/Watt	Weight kg	Code Snow White	Code Satin Silver	CHF
450	4000K	On/Off	Medium	2260lm/18W	5,5	MX3OWE-840M-D450-W	MX3OAE-840M-D450-A	1593,00
450	4000K	On/Off	High	3910lm/31W	5,5	MX3OWE-840H-D450-W	MX3OAE-840H-D450-A	1593,00
650	4000K	On/Off	Medium	5120lm/40W	7,5	MX3OWE-840M-D650-W	MX3OAE-840M-D650-A	2468,00
650	4000K	On/Off	High	7890lm/63W	7,5	MX3OWE-840H-D650-W	MX3OAE-840H-D650-A	2468,00
850	4000K	On/Off	Medium	7650lm/60W	11,4	MX3OWE-840M-D850-W	MX3OAE-840M-D850-A	3710,00
850	4000K	On/Off	High	10460lm/81W	11,4	MX3OWE-840H-D850-W	MX3OAE-840H-D850-A	3710,00

Opal Diffuser | Direct

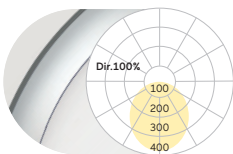

D mm	Colour Temperature	Control	Power	Lumen/Watt	Weight kg	Code Snow White	Code Satin Silver	CHF
450	4000K	On/Off	Medium	1470lm/12W	5,5	MY3OWE-840M-D450-W	MY3OAE-840M-D450-A	1435,00
450	4000K	On/Off	High	2550lm/21W	5,5	MY3OWE-840H-D450-W	MY3OAE-840H-D450-A	1435,00
650	4000K	On/Off	Medium	3300lm/25W	7,0	MY3OWE-840M-D650-W	MY3OAE-840M-D650-A	2275,00
650	4000K	On/Off	High	5370lm/42W	7,0	MY3OWE-840H-D650-W	MY3OAE-840H-D650-A	2275,00
850	4000K	On/Off	Medium	5180lm/40W	11,4	MY3OWE-840M-D850-W	MY3OAE-840M-D850-A	3500,00
850	4000K	On/Off	High	7010lm/54W	11,4	MY3OWE-840H-D850-W	MY3OAE-840H-D850-A	3500,00

Surcharges

Surface / Reflector Finish	CHF
Uni-Colours	
W...W: Snow White / Snow White	✓
A...A: Satin Silver / Satin Silver	+15%
U...U: Urban Graphite / Urban Graphite	✓
B...B: Jet Black / Jet Black	✓
H...H: Anodic Champ./ Anodic Champ.	+15%
K...K: Satin Copper / Satin Copper	+15%
Dual Colours	
W...G: Snow White / Satin Gold	+15%
W...K: Snow White / Satin Copper	+15%
W...B: Snow White / Jet Black	+15%
H...B: Anodic Champagne / Jet Black	+15%
B...G: Jet Black / Satin Gold	+15%
B...W: Jet Black / Snow White	+15%

Control Gear	CHF	CHF
	D450-D650	D850
E: On/Off	✓	✓
L: DALI	+86,00	+172,00
H: Touch-Dim	+86,00	+172,00
C: Casambi*	+261,00	+261,00
6: DALI DT6 for TW	+172,00	+343,00
8: DALI DT8 for TW	+172,00	+343,00

*Only in combination with DALI. Please add to dimming price.

Colour Rendering	CHF
8: CRI>80	✓
9: CRI>90	+5%
F: Full Spectrum	+15%

Colour Temperature	CHF
22: 2200K	+5%
27: 2700K	+5%
30: 3000K	✓
35: 3500K	+5%
40: 4000K	✓
65: 6500K	+5%
TW: Tunable White 2700-6500K* [D650-D850]	+30%

*Only in combination with DT6, DT8 or Casambi control. Please add additional control price.

Additional Options	CHF
Radar Sensor	+209,00
Emergency Module [DALI, Autotest, incl. 3H Battery]	+366,00

✓ standard / no extra charge ⚡ on request ✗ not available

Beam Me Up (Max) Y1/X1 | Surface

catalogue page 362



Microprismatic | Direct-Indirect

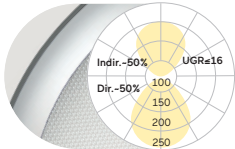

D mm	Colour TeMperature	Control	Power	Lumen/Watt	Weight kg	Code Snow White	Code Satin Silver	CHF
400	4000K	On/Off	Medium	2160lm/20W	5,5	MX1AWE-840M-D400-W	MX1AAE-840M-D400-A	1661,00
400	4000K	On/Off	High	3160lm/32W	5,5	MX1AWE-840H-D400-W	MX1AAE-840H-D400-A	1661,00
700	4000K	On/Off	Medium	5790lm/50W	8,5	MX1AWE-840M-D700-W	MX1AAE-840M-D700-A	2447,00
700	4000K	On/Off	High	8490lm/80W	8,5	MX1AWE-840H-D700-W	MX1AAE-840H-D700-A	2447,00
1200	4000K	On/Off	Medium	19470lm/177W	22,5	MX1AWE-840M-D1200-W	MX1AAE-840M-D1200-A	5592,00
1200	4000K	On/Off	High	26780lm/247W	22,5	MX1AWE-840H-D1200-W	MX1AAE-840H-D1200-A	5592,00

Microprismatic | Direct

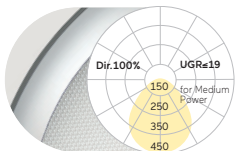

D mm	Colour Temperature	Control	Power	Lumen/Watt	Weight kg	Code Snow White	Code Satin Silver	CHF
400	4000K	On/Off	Medium	1090lm/14W	5,5	MY1AWE-840M-D400-W	MY1AAE-840M-D400-A	1574,00
400	4000K	On/Off	High	1600lm/22W	5,5	MY1AWE-840H-D400-W	MY1AAE-840H-D400-A	1574,00
700	4000K	On/Off	Medium	2920lm/35W	8,5	MY1AWE-840M-D700-W	MY1AAE-840M-D700-A	2272,00
700	4000K	On/Off	High	4290lm/52W	8,5	MY1AWE-840H-D700-W	MY1AAE-840H-D700-A	2272,00
1200	4000K	On/Off	Medium	8580lm/104W	22,5	MY1AWE-840M-D1200-W	MY1AAE-840M-D1200-A	5233,00
1200	4000K	On/Off	High	11220lm/139W	22,5	MY1AWE-840H-D1200-W	MY1AAE-840H-D1200-A	5233,00

Opal Diffuser | Direct-Indirect

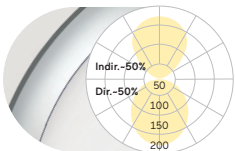

D mm	Colour Temperature	Control	Power	Lumen/Watt	Weight kg	Code Snow White	Code Satin Silver	CHF
400	4000K	On/Off	Medium	2210lm/20W	5,5	MX1OWE-840M-D400-W	MX1OAE-840M-D400-A	1574,00
400	4000K	On/Off	High	3240lm/32W	5,5	MX1OWE-840H-D400-W	MX1OAE-840H-D400-A	1574,00
700	4000K	On/Off	Medium	5930lm/50W	8,5	MX1OWE-840M-D700-W	MX1OAE-840M-D700-A	2258,00
700	4000K	On/Off	High	8690lm/80W	8,5	MX1OWE-840H-D700-W	MX1OAE-840H-D700-A	2258,00
1200	4000K	On/Off	Medium	19870lm/177W	22,5	MX1OWE-840M-D1200-W	MX1OAE-840M-D1200-A	5233,00
1200	4000K	On/Off	High	27310lm/247W	22,5	MX1OWE-840H-D1200-W	MX1OAE-840H-D1200-A	5233,00

Opal Diffuser | Direct

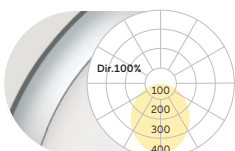

D mm	Colour Temperature	Control	Power	Lumen/Watt	Weight kg	Code Snow White	Code Satin Silver	CHF
400	4000K	On/Off	Medium	1140lm/14W	5,5	MY1OWE-840M-D400-W	MY1OAE-840M-D400-A	1486,00
400	4000K	On/Off	High	1680lm/22W	5,5	MY1OWE-840H-D400-W	MY1OAE-840H-D400-A	1486,00
700	4000K	On/Off	Medium	3060lm/35W	8,5	MY1OWE-840M-D700-W	MY1OAE-840M-D700-A	2083,00
700	4000K	On/Off	High	4490lm/52W	8,5	MY1OWE-840H-D700-W	MY1OAE-840H-D700-A	2083,00
1200	4000K	On/Off	Medium	8980lm/104W	22,5	MY1OWE-840M-D1200-W	MY1OAE-840M-D1200-A	4883,00
1200	4000K	On/Off	High	11750lm/139W	22,5	MY1OWE-840H-D1200-W	MY1OAE-840H-D1200-A	4883,00

Surface / Reflector Finish		CHF	Control Gear		CHF	CHF	Colour Temperature	CHF	Additional Options	CHF
Uni-Colours										
W...W: Snow White / Snow White	✓		E: On/Off	✓	D450-D700	D1200	22: 2200K	+5%	Radar Sensor	+209,00
A...A: Satin Silver / Satin Silver	✓		L: DALI	✓	+86,00	+172,00	27: 2700K	+5%	Emergency Module [DALI, Autotest, incl. 3H Battery]	+366,00
U...U: Urban Graphite / Urban Graphite	✓		H: Touch-Dim	✓	+86,00	+172,00	30: 3000K	✓		
B...B: Jet Black / Jet Black	✓		C: Casambi	✓	+261,00	+261,00	35: 3500K	+5%		
H...H: Anodic Champ./ Anodic Champ.	✓		6: DALI DT6 for TW	✓	+172,00	+343,00	40: 4000K	✓		
K...K: Satin Copper / Satin Copper	✓		8: DALI DT8 for TW	✓	+172,00	+343,00	65: 6500K	+5%		
Dual Colours										
W...G: Snow White / Satin Gold	+15%		Colour Rendering		CHF		TW: Tunable White 2700-6500K*		+30%	
W...K: Snow White / Satin Copper	+15%		8: CRI>80	✓			*Only in combination with DT6, DT8 or Casambi control. Please add additional control price.			
W...B: Snow White / Jet Black	+15%		9: CRI>90	+5%						
H...B: Anodic Champagne / Jet Black	+15%		F: Full Spectrum	+15%						
B...G: Jet Black / Satin Gold	+15%									
B...W: Jet Black / Snow White	+15%									

✓ standard / no extra charge
🟡 on request
✗ not available

Beam Me Up (Wallwasher) A4 | Surface

catalogue page 364



Microprismatic | Direct

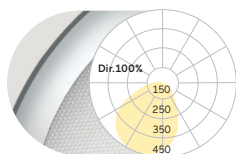

D mm	Colour Temperature	Control	Power	Lumen/Watt	Weight kg	Code Snow White	Code Satin Silver	CHF
700	4000K	On/Off	Medium	3060lm/35W	10,0	MA4AW E -840M-D700-W	MA4AA E -840M-D700-A	1966,00
700	4000K	On/Off	High	4490lm/52W	10,0	MA4AW E -840H-D700-W	MA4AA E -840H-D700-A	1966,00
1200	4000K	On/Off	Medium	8980lm/104W	20,0	MA4AW E -840M-D1200-W	MA4AA E -840M-D1200-A	4760,00
1200	4000K	On/Off	High	11750lm/139W	20,0	MA4AW E -840H-D1200-W	MA4AA E -840H-D1200-A	4760,00

Opal Diffuser | Direct

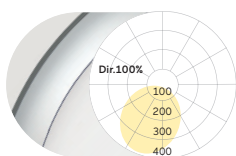

D mm	Colour Temperature	Control	Power	Lumen/Watt	Weight kg	Code Snow White	Code Satin Silver	CHF
700	4000K	On/Off	Medium	3160lm/35W	10,0	MA4O W E-840M-D700-W	MA4O A E-840M-D700-A	1785,00
700	4000K	On/Off	High	4650lm/52W	10,0	MA4O W E-840H-D700-W	MA4O A E-840H-D700-A	1785,00
1200	4000K	On/Off	Medium	9300lm/104W	20,0	MA4O W E-840M-D1200-W	MA4O A E-840M-D1200-A	4489,00
1200	4000K	On/Off	High	12160lm/139W	20,0	MA4O W E-840H-D1200-W	MA4O A E-840H-D1200-A	4489,00

Surface / Reflector Finish		CHF	Control Gear		CHF	CHF	Colour Temperature	CHF	Additional Options	CHF
Uni-Colours										
W...W: Snow White / Snow White	✓		E: On/Off	✓	D700	D1200	22: 2200K	+5%	Radar Sensor	+209,00
A...A: Satin Silver / Satin Silver	✓		L: DALI	✓	+86,00	+172,00	27: 2700K	+5%	Emergency Module [DALI, Autotest, incl. 3H Battery]	+366,00
U...U: Urban Graphite / Urban Graphite	✓		H: Touch-Dim	✓	+86,00	+172,00	30: 3000K	✓		
B...B: Jet Black / Jet Black	✓		C: Casambi*	✓	+261,00	+261,00	35: 3500K	+5%		
H...H: Anodic Champ./ Anodic Champ.	✓		6: DALI DT6 for TW	✓	+172,00	+343,00	40: 4000K	✓		
K...K: Satin Copper / Satin Copper	✓		8: DALI DT8 for TW	✓	+172,00	+343,00	65: 6500K	+5%		
Dual Colours										
W...G: Snow White / Satin Gold	+15%		*Only in combination with DALI. Please add to dimming price.				TW: Tunable White 2700-6500K*		+30%	
W...K: Snow White / Satin Copper	+15%		Colour Rendering		CHF		*Only in combination with DT6, DT8 or Casambi control. Please add additional control price.			
W...B: Snow White / Jet Black	+15%		8: CRI>80	✓						
H...B: Anodic Champagne / Jet Black	+15%		9: CRI>90	+5%						
B...G: Jet Black / Satin Gold	+15%		F: Full Spectrum	+15%						
B...W: Jet Black / Snow White	+15%									

✓ standard / no extra charge
🟡 on request
✗ not available

Ringo Star Compact A5 | Surface

catalogue page 366

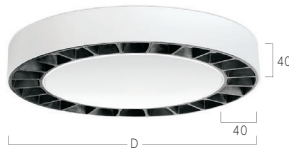

Lens Louvre | Direct

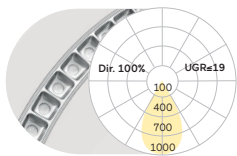

D mm	Colour Temperature	Control	Power	Lumen/Watt	Weight kg	Code Snow White/Jet Black	Code Jet Black/Jet Black	CHF
200	4000K	On/Off	Low	1570lm/13W	1,5	RA5LWE-840E-D200-B-BP	RA5LBE-840E-D200-B-BP	611,00
200	4000K	On/Off	High	2660lm/23W	1,5	RA5LWE-840H-D200-B-BP	RA5LBE-840H-D200-B-BP	611,00
270	4000K	On/Off	Low	1860lm/15W	2,0	RA5LWE-840E-D270-B-BP	RA5LBE-840E-D270-B-BP	786,00
270	4000K	On/Off	High	3110lm/26W	2,0	RA5LWE-840H-D270-B-BP	RA5LBE-840H-D270-B-BP	786,00
370	4000K	On/Off	Low	2480lm/20W	3,5	RA5LWE-840E-D370-B-BP	RA5LBE-840E-D370-B-BP	1014,00
370	4000K	On/Off	High	4140lm/34W	3,5	RA5LWE-840H-D370-B-BP	RA5LBE-840H-D370-B-BP	1014,00



EM Emergency Module



MM Multisensor



AS Air Supply



Camera

Surcharges

Surface Finish	CHF	Control Gear	CHF	Colour Temperature	CHF	Lens Louvre	CHF	Central Module	CHF
W: Snow White	✓	E: On/Off	✓	22: 2200K	+5%	W: Snow White	✓	BP: Blind Plate	✓
V: Ivory White	✓	L: DALI	+86,00	27: 2700K	+5%	A: Satin Silver	✓	EM: Emergency Module	+366,00
A: Satin Silver	+15%	H: Touch-Dim	+86,00	30: 3000K	✓	B: Jet Black	✓	MP: Midpoint Spotlight	+368,00
U: Urban Graphite	✓	Colour Rendering	CHF	35: 3500K	+5%	H: Anodic Champagne	✓	MM: Multisensor	+261,00
B: Jet Black	✓	8: CRI>80	✓	40: 4000K	✓	K: Satin Copper	✓	Additional Options	CHF
H: Anodic Champagne	+10%	9: CRI>90	+5%	65: 6500K	+5%	G: Satin Gold	✓	Casambi	ⓘ
K: Satin Copper	+15%	F: Full Spectrum	+15%					Camera	ⓘ
R: Special RAL/NCS Colours	ⓘ								

✓ standard / no extra charge ⓘ on request ✗ not available

Ringo Star AX | System 40mm Surface

catalogue page 368



Microprismatic | Direct

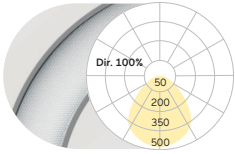

D mm	Colour Temperature	Control	Power	Lumen/Watt	Weight kg	Code Snow White	Code Radiant Silver	CHF
600	4000K	On/Off	Low	2000lm/25W	7,0	RA3AWE-840E-D600	RA3ASE-840E-D600	1955,00
600	4000K	On/Off	Medium	2920lm/37W	7,0	RA3AWE-840M-D600	RA3ASE-840M-D600	1955,00
600	4000K	On/Off	High	3960lm/53W	7,0	RA3AWE-840H-D600	RA3ASE-840H-D600	1955,00
900	4000K	On/Off	Low	3190lm/40W	9,0	RA3AWE-840E-D900	RA3ASE-840E-D900	2660,00
900	4000K	On/Off	Medium	4650lm/59W	9,0	RA3AWE-840M-D900	RA3ASE-840M-D900	2660,00
900	4000K	On/Off	High	6030lm/80W	9,0	RA3AWE-840H-D900	RA3ASE-840H-D900	2660,00
1200	4000K	On/Off	Low	4450lm/57W	11,5	RA3AWE-840E-D1200	RA3ASE-840E-D1200	3031,00
1200	4000K	On/Off	Medium	6080lm/81W	11,5	RA3AWE-840M-D1200	RA3ASE-840M-D1200	3031,00
1200	4000K	On/Off	High	8360lm/121W	11,5	RA3AWE-840H-D1200	RA3ASE-840H-D1200	3031,00
1500	4000K	On/Off	Low	5620lm/69W	14,0	RA3AWE-840E-D1500	RA3ASE-840E-D1500	4480,00
1500	4000K	On/Off	Medium	8220lm/106W	14,0	RA3AWE-840M-D1500	RA3ASE-840M-D1500	4480,00
1500	4000K	On/Off	High	10700lm/143W	14,0	RA3AWE-840H-D1500	RA3ASE-840H-D1500	4480,00
2000	4000K	On/Off	Low	7500lm/96W	20,0	RA3AWE-840E-D2000	RA3ASE-840E-D2000	6964,00
2000	4000K	On/Off	Medium	10730lm/142W	20,0	RA3AWE-840M-D2000	RA3ASE-840M-D2000	6964,00
2000	4000K	On/Off	High	14230lm/203W	20,0	RA3AWE-840H-D2000	RA3ASE-840H-D2000	6964,00
2500	4000K	On/Off	Low	9140lm/114W	25,0	RA3AWE-840E-D2500	RA3ASE-840E-D2500	7907,00
2500	4000K	On/Off	Medium	13360lm/173W	25,0	RA3AWE-840M-D2500	RA3ASE-840M-D2500	7907,00
2500	4000K	On/Off	High	17390lm/237W	25,0	RA3AWE-840H-D2500	RA3ASE-840H-D2500	7907,00
3000	4000K	On/Off	Low	11240lm/138W	31,0	RA3AWE-840E-D3000	RA3ASE-840E-D3000	9030,00
3000	4000K	On/Off	Medium	16450lm/211W	31,0	RA3AWE-840M-D3000	RA3ASE-840M-D3000	9030,00
3000	4000K	On/Off	High	21400lm/287W	31,0	RA3AWE-840H-D3000	RA3ASE-840H-D3000	9030,00
3500	4000K	On/Off	Low	13350lm/172W	36,0	RA3AWE-840E-D3500	RA3ASE-840E-D3500	10166,00
3500	4000K	On/Off	Medium	19530lm/259W	36,0	RA3AWE-840M-D3500	RA3ASE-840M-D3500	10166,00
3500	4000K	On/Off	High	25420lm/352W	36,0	RA3AWE-840H-D3500	RA3ASE-840H-D3500	10166,00
4000	4000K	On/Off	Low	15420lm/196W	41,0	RA3AWE-840E-D4000	RA3ASE-840E-D4000	11918,00
4000	4000K	On/Off	Medium	22520lm/297W	41,0	RA3AWE-840M-D4000	RA3ASE-840M-D4000	11918,00
4000	4000K	On/Off	High	29270lm/405W	41,0	RA3AWE-840H-D4000	RA3ASE-840H-D4000	11918,00
5000	4000K	On/Off	Low	18970lm/231W	48,0	RA3AWE-840E-D5000	RA3ASE-840E-D5000	14748,00
5000	4000K	On/Off	Medium	27760lm/356W	48,0	RA3AWE-840M-D5000	RA3ASE-840M-D5000	14748,00
5000	4000K	On/Off	High	36120lm/479W	48,0	RA3AWE-840H-D5000	RA3ASE-840H-D5000	14748,00
6000	4000K	On/Off	Low	22490lm/276W	56,0	RA3AWE-840E-D6000	RA3ASE-840E-D6000	18020,00
6000	4000K	On/Off	Medium	32900lm/423W	56,0	RA3AWE-840M-D6000	RA3ASE-840M-D6000	18020,00
6000	4000K	On/Off	High	42810lm/574W	56,0	RA3AWE-840H-D6000	RA3ASE-840H-D6000	18020,00
7000	4000K	On/Off	Low	25300lm/308W	72,0	RA3AWE-840E-D7000	RA3ASE-840E-D7000	21485,00
7000	4000K	On/Off	Medium	37000lm/474W	72,0	RA3AWE-840M-D7000	RA3ASE-840M-D7000	21485,00
7000	4000K	On/Off	High	48160lm/638W	72,0	RA3AWE-840H-D7000	RA3ASE-840H-D7000	21485,00
8000	4000K	On/Off	Low	29520lm/376W	80,0	RA3AWE-840E-D8000	RA3ASE-840E-D8000	25759,00
8000	4000K	On/Off	Medium	43180lm/568W	80,0	RA3AWE-840M-D8000	RA3ASE-840M-D8000	25759,00
8000	4000K	On/Off	High	56190lm/774W	80,0	RA3AWE-840H-D8000	RA3ASE-840H-D8000	25759,00

Opal Diffuser | Direct

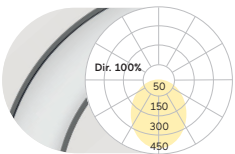

D mm	Colour Temperature	Control	Power	Lumen/Watt	Weight kg	Code Snow White	Code Radiant Silver	CHF
600	4000K	On/Off	Low	2170lm/25W	7,0	RA3OWE-840E-D600	RA3OSE-840E-D600	1862,00
600	4000K	On/Off	Medium	3170lm/37W	7,0	RA3OWE-840M-D600	RA3OSE-840M-D600	1862,00
600	4000K	On/Off	High	4300lm/53W	7,0	RA3OWE-840H-D600	RA3OSE-840H-D600	1862,00
900	4000K	On/Off	Low	3460lm/40W	9,0	RA3OWE-840E-D900	RA3OSE-840E-D900	2494,00
900	4000K	On/Off	Medium	5050lm/59W	9,0	RA3OWE-840M-D900	RA3OSE-840M-D900	2494,00
900	4000K	On/Off	High	6540lm/80W	9,0	RA3OWE-840H-D900	RA3OSE-840H-D900	2494,00
1200	4000K	On/Off	Low	4830lm/57W	11,5	RA3OWE-840E-D1200	RA3OSE-840E-D1200	2865,00
1200	4000K	On/Off	Medium	6600lm/81W	11,5	RA3OWE-840M-D1200	RA3OSE-840M-D1200	2865,00
1200	4000K	On/Off	High	9080lm/121W	11,5	RA3OWE-840H-D1200	RA3OSE-840H-D1200	2865,00
1500	4000K	On/Off	Low	6100lm/69W	14,0	RA3OWE-840E-D1500	RA3OSE-840E-D1500	3903,00
1500	4000K	On/Off	Medium	8920lm/106W	14,0	RA3OWE-840M-D1500	RA3OSE-840M-D1500	3903,00
1500	4000K	On/Off	High	11610lm/143W	14,0	RA3OWE-840H-D1500	RA3OSE-840H-D1500	3903,00
2000	4000K	On/Off	Low	8140lm/96W	20,0	RA3OWE-840E-D2000	RA3OSE-840E-D2000	6386,00
2000	4000K	On/Off	Medium	11650lm/142W	20,0	RA3OWE-840M-D2000	RA3OSE-840M-D2000	6386,00
2000	4000K	On/Off	High	15450lm/203W	20,0	RA3OWE-840H-D2000	RA3OSE-840H-D2000	6386,00
2500	4000K	On/Off	Low	9910lm/114W	25,0	RA3OWE-840E-D2500	RA3OSE-840E-D2500	7368,00
2500	4000K	On/Off	Medium	14500lm/173W	25,0	RA3OWE-840M-D2500	RA3OSE-840M-D2500	7368,00
2500	4000K	On/Off	High	18870lm/237W	25,0	RA3OWE-840H-D2500	RA3OSE-840H-D2500	7368,00
3000	4000K	On/Off	Low	12200lm/138W	31,0	RA3OWE-840E-D3000	RA3OSE-840E-D3000	8280,00
3000	4000K	On/Off	Medium	17850lm/211W	31,0	RA3OWE-840M-D3000	RA3OSE-840M-D3000	8280,00
3000	4000K	On/Off	High	23230lm/287W	31,0	RA3OWE-840H-D3000	RA3OSE-840H-D3000	8280,00
3500	4000K	On/Off	Low	14490lm/172W	36,0	RA3OWE-840E-D3500	RA3OSE-840E-D3500	9415,00
3500	4000K	On/Off	Medium	21200lm/259W	36,0	RA3OWE-840M-D3500	RA3OSE-840M-D3500	9415,00
3500	4000K	On/Off	High	27580lm/352W	36,0	RA3OWE-840H-D3500	RA3OSE-840H-D3500	9415,00
4000	4000K	On/Off	Low	16730lm/196W	41,0	RA3OWE-840E-D4000	RA3OSE-840E-D4000	10975,00
4000	4000K	On/Off	Medium	24440lm/297W	41,0	RA3OWE-840M-D4000	RA3OSE-840M-D4000	10975,00
4000	4000K	On/Off	High	31760lm/405W	41,0	RA3OWE-840H-D4000	RA3OSE-840H-D4000	10975,00
5000	4000K	On/Off	Low	20590lm/231W	48,0	RA3OWE-840E-D5000	RA3OSE-840E-D5000	14228,00
5000	4000K	On/Off	Medium	30120lm/356W	48,0	RA3OWE-840M-D5000	RA3OSE-840M-D5000	14228,00
5000	4000K	On/Off	High	39200lm/479W	48,0	RA3OWE-840H-D5000	RA3OSE-840H-D5000	14228,00
6000	4000K	On/Off	Low	24400lm/276W	56,0	RA3OWE-840E-D6000	RA3OSE-840E-D6000	16942,00
6000	4000K	On/Off	Medium	35700lm/423W	56,0	RA3OWE-840M-D6000	RA3OSE-840M-D6000	16942,00
6000	4000K	On/Off	High	46450lm/574W	56,0	RA3OWE-840H-D6000	RA3OSE-840H-D6000	16942,00
7000	4000K	On/Off	Low	27450lm/308W	72,0	RA3OWE-840E-D7000	RA3OSE-840E-D7000	19945,00
7000	4000K	On/Off	Medium	40160lm/474W	72,0	RA3OWE-840M-D7000	RA3OSE-840M-D7000	19945,00
7000	4000K	On/Off	High	52260lm/638W	72,0	RA3OWE-840H-D7000	RA3OSE-840H-D7000	19945,00
8000	4000K	On/Off	Low	32000lm/376W	80,0	RA3OWE-840E-D8000	RA3OSE-840E-D8000	23487,00
8000	4000K	On/Off	Medium	46850lm/568W	80,0	RA3OWE-840M-D8000	RA3OSE-840M-D8000	23487,00
8000	4000K	On/Off	High	60970lm/774W	80,0	RA3OWE-840H-D8000	RA3OSE-840H-D8000	23487,00

... Ringo Star A3 | System 60mm Surface

Surcharges

Surface Finish

W: Snow White	✓
V: Ivory White	✓
S: Radiant Silver	✓
U: Urban Graphite	✓
B: Jet Black	✓
H: Anodic Champagne	+10%
K: Satin Copper	+15%
R: Special RAL/NCS Colours	ⓘ

CHF

Control Gear

E: On/Off	✓
L: DALI	+86,00
H: Touch-Dim	+86,00
C: Casambi*	+261,00
6: DALI DT6 for TW	+172,00
8: DALI DT8 for TW	+172,00

*Only in combination with DALI. Please add to dimming price.

CHF

CHF

CHF

CHF

D600-D1200 D1500-D2500 D3000-D8000

Colour Rendering

8: CRI>80	✓
9: CRI>90	+5%
F: Full Spectrum	+15%

Colour Temperature

22: 2200K	+5%
27: 2700K	+5%
30: 3000K	✓
35: 3500K	+5%
40: 4000K	✓
65: 6500K	+5%

TW: Tunable White 2700-6500K* [D1500-D8000]

*Only in combination with DT6, DT8 or Casambi control. Please add additional control price.

CHF

Additional Options

Emergency Module [DALI, Autotest, incl. 3H Battery] [D1500-D8000]	+366,00
Midpin Spotlight XP	+433,00

CHF

✓ standard / no extra charge ⓘ on request ✗ not available

Ringo Star A1 | System 100mm Surface

catalogue page **372**



Microprismatic | Direct

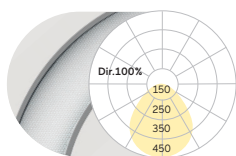

D mm	Colour Temperature	Control	Power	Lumen/Watt	Weight kg	Code Snow White	Code Radiant Silver	CHF
600	4000K	On/Off	Low	3810lm/34W	6,0	RA1AWE-840E-D600	RA1ASE-840E-D600	2151,00
600	4000K	On/Off	Medium	4790lm/45W	6,0	RA1AWE-840M-D600	RA1ASE-840M-D600	2151,00
900	4000K	On/Off	Low	6460lm/59W	9,0	RA1AWE-840E-D900	RA1ASE-840E-D900	2979,00
900	4000K	On/Off	Medium	7900lm/75W	9,0	RA1AWE-840M-D900	RA1ASE-840M-D900	2979,00
1200	4000K	On/Off	Low	8750lm/79W	12,6	RA1AWE-840E-D1200	RA1ASE-840E-D1200	4060,00
1200	4000K	On/Off	Medium	10260lm/95W	12,6	RA1AWE-840M-D1200	RA1ASE-840M-D1200	4060,00
1500	4000K	On/Off	Low	10980lm/98W	18,0	RA1AWE-840E-D1500	RA1ASE-840E-D1500	4692,00
1500	4000K	On/Off	Medium	13200lm/120W	18,0	RA1AWE-840M-D1500	RA1ASE-840M-D1500	4692,00
2000	4000K	On/Off	Low	14650lm/131W	22,0	RA1AWE-840E-D2000	RA1ASE-840E-D2000	7189,00
2000	4000K	On/Off	Medium	18330lm/168W	22,0	RA1AWE-840M-D2000	RA1ASE-840M-D2000	7189,00
2500	4000K	On/Off	Low	18900lm/166W	28,0	RA1AWE-840E-D2500	RA1ASE-840E-D2500	8969,00
2500	4000K	On/Off	Medium	23090lm/207W	28,0	RA1AWE-840M-D2500	RA1ASE-840M-D2500	8969,00
3000	4000K	On/Off	Low	23260lm/202W	34,0	RA1AWE-840E-D3000	RA1ASE-840E-D3000	10681,00
3000	4000K	On/Off	Medium	28420lm/252W	34,0	RA1AWE-840M-D3000	RA1ASE-840M-D3000	10681,00
3500	4000K	On/Off	Low	26170lm/227W	41,0	RA1AWE-840E-D3500	RA1ASE-840E-D3500	12072,00
3500	4000K	On/Off	Medium	31970lm/281W	41,0	RA1AWE-840M-D3500	RA1ASE-840M-D3500	12072,00
4000	4000K	On/Off	Low	30530lm/271W	47,0	RA1AWE-840E-D4000	RA1ASE-840E-D4000	13965,00
4000	4000K	On/Off	Medium	37290lm/338W	47,0	RA1AWE-840M-D4000	RA1ASE-840M-D4000	13965,00
5000	4000K	On/Off	Low	37800lm/332W	60,0	RA1AWE-840E-D5000	RA1ASE-840E-D5000	17378,00
5000	4000K	On/Off	Medium	46170lm/414W	60,0	RA1AWE-840M-D5000	RA1ASE-840M-D5000	17378,00
6000	4000K	On/Off	Low	46520lm/405W	71,0	RA1AWE-840E-D6000	RA1ASE-840E-D6000	20866,00
6000	4000K	On/Off	Medium	56830lm/504W	71,0	RA1AWE-840M-D6000	RA1ASE-840M-D6000	20866,00
7000	4000K	On/Off	Low	55240lm/496W	82,0	RA1AWE-840E-D7000	RA1ASE-840E-D7000	24205,00
7000	4000K	On/Off	Medium	67490lm/617W	82,0	RA1AWE-840M-D7000	RA1ASE-840M-D7000	24205,00
8000	4000K	On/Off	Low	61780lm/536W	94,0	RA1AWE-840E-D8000	RA1ASE-840E-D8000	27654,00
8000	4000K	On/Off	Medium	75480lm/667W	94,0	RA1AWE-840M-D8000	RA1ASE-840M-D8000	27654,00



Midpin Spotlight XP
1000lm/19W-3000lm/31W Ø90mm

Opal Diffuser | Direct

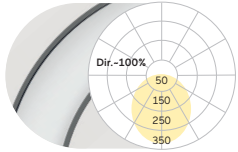

D mm	Colour Temperature	Control	Power	Lumen/Watt	Weight kg	Code Snow White	Code Radiant Silver	CHF
600	4000K	On/Off	Low	4090lm/34W	6,0	RA1OWE-840E-D600	RA1OSE-840E-D600	2060,00
600	4000K	On/Off	Medium	5150lm/45W	6,0	RA1OWE-840M-D600	RA1OSE-840M-D600	2060,00
900	4000K	On/Off	Low	6930lm/59W	9,0	RA1OWE-840E-D900	RA1OSE-840E-D900	2799,00
900	4000K	On/Off	Medium	8490lm/75W	9,0	RA1OWE-840M-D900	RA1OSE-840M-D900	2799,00
1200	4000K	On/Off	Low	9400lm/79W	12,6	RA1OWE-840E-D1200	RA1OSE-840E-D1200	3791,00
1200	4000K	On/Off	Medium	11030lm/95W	12,6	RA1OWE-840M-D1200	RA1OSE-840M-D1200	3791,00
1500	4000K	On/Off	Low	11800lm/98W	18,0	RA1OWE-840E-D1500	RA1OSE-840E-D1500	4307,00
1500	4000K	On/Off	Medium	14180lm/120W	18,0	RA1OWE-840M-D1500	RA1OSE-840M-D1500	4307,00
2000	4000K	On/Off	Low	15730lm/131W	22,0	RA1OWE-840E-D2000	RA1OSE-840E-D2000	6726,00
2000	4000K	On/Off	Medium	19690lm/168W	22,0	RA1OWE-840M-D2000	RA1OSE-840M-D2000	6726,00
2500	4000K	On/Off	Low	20300lm/166W	28,0	RA1OWE-840E-D2500	RA1OSE-840E-D2500	8413,00
2500	4000K	On/Off	Medium	24800lm/207W	28,0	RA1OWE-840M-D2500	RA1OSE-840M-D2500	8413,00
3000	4000K	On/Off	Low	24990lm/202W	34,0	RA1OWE-840E-D3000	RA1OSE-840E-D3000	10031,00
3000	4000K	On/Off	Medium	30520lm/252W	34,0	RA1OWE-840M-D3000	RA1OSE-840M-D3000	10031,00
3500	4000K	On/Off	Low	28110lm/227W	41,0	RA1OWE-840E-D3500	RA1OSE-840E-D3500	11330,00
3500	4000K	On/Off	Medium	34340lm/281W	41,0	RA1OWE-840M-D3500	RA1OSE-840M-D3500	11330,00
4000	4000K	On/Off	Low	32790lm/271W	47,0	RA1OWE-840E-D4000	RA1OSE-840E-D4000	13131,00
4000	4000K	On/Off	Medium	40060lm/338W	47,0	RA1OWE-840M-D4000	RA1OSE-840M-D4000	13131,00
5000	4000K	On/Off	Low	40600lm/332W	60,0	RA1OWE-840E-D5000	RA1OSE-840E-D5000	16450,00
5000	4000K	On/Off	Medium	49600lm/414W	60,0	RA1OWE-840M-D5000	RA1OSE-840M-D5000	16450,00
6000	4000K	On/Off	Low	49970lm/405W	71,0	RA1OWE-840E-D6000	RA1OSE-840E-D6000	19845,00
6000	4000K	On/Off	Medium	61050lm/504W	71,0	RA1OWE-840M-D6000	RA1OSE-840M-D6000	19845,00
7000	4000K	On/Off	Low	59340lm/496W	82,0	RA1OWE-840E-D7000	RA1OSE-840E-D7000	23092,00
7000	4000K	On/Off	Medium	72500lm/617W	82,0	RA1OWE-840M-D7000	RA1OSE-840M-D7000	23092,00
8000	4000K	On/Off	Low	66370lm/536W	94,0	RA1OWE-840E-D8000	RA1OSE-840E-D8000	26448,00
8000	4000K	On/Off	Medium	81080lm/667W	94,0	RA1OWE-840M-D8000	RA1OSE-840M-D8000	26448,00

Surcharges

Surface Finish

- W: Snow White
- V: Ivory White
- S: Radiant Silver
- U: Urban Graphite
- B: Jet Black
- H: Anodic Champagne
- K: Satin Copper
- R: Special RAL/NCS Colours

CHF

- ✓
- ✓
- ✓
- ✓
- ✓
- +10%
- +15%
- ⓘ

Control Gear

- E: On/Off
- L: DALI
- H: Touch-Dim
- C: Casambi*
- G: DALI DT6 for TW
- 8: DALI DT8 for TW [D900-D8000]

CHF

- ✓
- +86,00
- +86,00
- +261,00
- +172,00
- +172,00

CHF

- ✓
- ⓘ
- ⓘ
- ⓘ
- ⓘ
- ⓘ

Colour Temperature

- 22: 2200K
- 27: 2700K
- 30: 3000K
- 35: 3500K
- 40: 4000K
- 65: 6500K
- TW: Tunable White 2700-6500K*

CHF

- +5%
- +5%
- ✓
- +5%
- ✓
- +5%
- +30%

Colour Rendering

- 8: CRI>80
- 9: CRI>90
- F: Full Spectrum

CHF

- ✓
- +5%
- +15%

Additional Options

- Emergency Module [DALI, Autotest, incl. 3H Battery] [D1200-D8000]
- Midpin Spotlight XP

CHF

- +366,00
- +433,00

✓ standard / no extra charge ⓘ on request ✗ not available

*Only in combination with DT6, DT8 or Casambi control. Please add additional control price.

Liquid Line Compact A5 | Surface

catalogue page 374

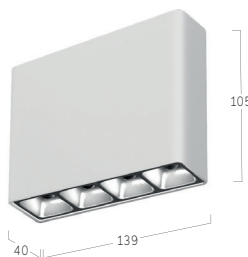

Lens Louvre | Direct

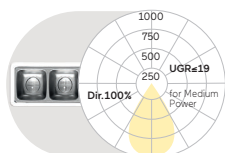

L mm	Colour Temperature	Control	Power	Lumen/Watt	Weight kg	Code Snow White/Jet Black	Code Jet Black/Jet Black	CHF
139	4000K	On/Off	Medium	620lm/7W	0,7	QA5LWE-840M-L139-B*	QA5LBE-840M-L139-B*	674,00
139	4000K	On/Off	High	820lm/9W	0,7	QA5LWE-840H-L139-B*	QA5LBE-840H-L139-B*	674,00

Opal Diffuser | Direct

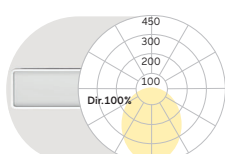

L mm	Colour Temperature	Control	Power	Lumen/Watt	Weight kg	Code Snow White	Code Jet Black	CHF
139	4000K	On/Off	Medium	530lm/7W	0,7	QA5OWE-840M-L139	QA5OBE-840M-L139	592,00
139	4000K	On/Off	High	720lm/9W	0,7	QA5OWE-840H-L139	QA5OBE-840H-L139	592,00

Surcharges									
Surface Finish	CHF	Control Gear	CHF	Colour Rendering	CHF	Colour Temperature	CHF	Lens Louvre*	CHF
W: Snow White	✓	E: On/Off	✓	8: CRI>80	✓	22: 2200K	+5%	W: Snow White	✓
V: Ivory White	✓	L: DALI	+172,00	9: CRI>90	+5%	27: 2700K	+5%	A: Satin Silver	✓
A: Satin Silver	+15%	H: Touch-Dim	+172,00	F: Full Spectrum	+15%	30: 3000K	✓	B: Jet Black	✓
S: Radiant Silver	✓					35: 3500K	+5%	H: Anodic Champagne	✓
U: Urban Graphite	✓					40: 4000K	✓	G: Satin Gold	✓
B: Jet Black	✓					65: 6500K	+5%	K: Satin Copper	✓
H: Anodic Champagne	+10%								
K: Satin Copper	+15%								
R: Special RAL/NCS Colours	🕒								

✓ standard / no extra charge
 🕒 on request
 ✗ not available

Liquid Line AX | System 40mm Surface

catalogue page 376

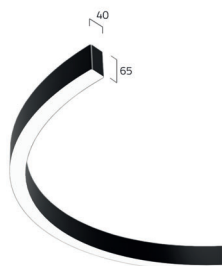

DE System aus linearen, vertikal und horizontal gebogenen Komponenten sowie Y- und X-Verbindungselementen. Auf Grundlage skizzierter Kundenvorgabe erstellt Lightnet technische Zeichnung der gewünschten Struktur zur Prüfung und Freigabe. Zeichnungen für mögliche Radien, X- und Y-Module siehe Katalog. Sonderradien bei Opal-Flex Diffuser möglich.

EN System consisting of linear elements, vertically and horizontally curved elements and Y- and X-connectors. Based on customer specification, Lightnet creates technical drawings of the desired structure for review and approval. For drawings of possible curves, X- and Y-modules, see catalog. Special curves possible for Opal-Flex diffuser.

FR Système d'éclairage sur-mesure des éléments/modules droits-linéaires, verticaux et horizontaux cintrés, tout comme des connections/jonctions en forme de Y et X. Sur la base des schémas et spécifications voulues par le client, Lightnet crée les dessins techniques de la structure sur-mesure souhaitée pour contrôle et validation avant mise en production. Pour les dessins des rayons possibles et des modules X et Y, voir le catalogue. Rayons spéciaux possibles pour les diffusifs Opal-Flex.



Lens Louvre | Direct

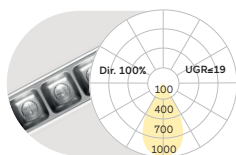

L mm	Colour Temperature	Control	Power	Lumen/Watt	Weight kg	Code Snow White/Jet Black	Code Jet Black/Jet Black	CHF
Liquid Line per meter (Lineare Teilstücke Straight Sections Sections droites)								
per meter	4000K	On/Off	Low	1640lm/12,6W	2,3	QAXLWE-840E-L****-B*	QAXLBE-840E-L****-B*	637,00
per meter	4000K	On/Off	Medium	2340lm/18,4W	2,3	QAXLWE-840M-L****-B*	QAXLBE-840M-L****-B*	637,00
per meter	4000K	On/Off	High	3020lm/24,3W	2,3	QAXLWE-840H-L****-B*	QAXLBE-840H-L****-B*	637,00
per meter	4000K	DALI	Low	1640lm/12,6W	2,3	QAXLWL-840E-L****-B*	QAXLBL-840E-L****-B*	690,00
per meter	4000K	DALI	Medium	2340lm/18,4W	2,3	QAXLWL-840M-L****-B*	QAXLBL-840M-L****-B*	690,00
per meter	4000K	DALI	High	3020lm/24,3W	2,3	QAXLWL-840H-L****-B*	QAXLBL-840H-L****-B*	690,00

Liquid Line per meter (Gebogene Teilstücke Curved and bent Sections Courbes Sections)								
per meter	4000K	On/Off	Low	1640lm/12,6W	2,3	QAXLWE-840E-L****-B*	QAXLBE-840E-L****-B*	1196,00
per meter	4000K	On/Off	Medium	2340lm/18,4W	2,3	QAXLWE-840M-L****-B*	QAXLBE-840M-L****-B*	1196,00
per meter	4000K	On/Off	High	3020lm/24,3W	2,3	QAXLWE-840H-L****-B*	QAXLBE-840H-L****-B*	1196,00
per meter	4000K	DALI	Low	1640lm/12,6W	2,3	QAXLWL-840E-L****-B*	QAXLBL-840E-L****-B*	1248,00
per meter	4000K	DALI	Medium	2340lm/18,4W	2,3	QAXLWL-840M-L****-B*	QAXLBL-840M-L****-B*	1248,00
per meter	4000K	DALI	High	3020lm/24,3W	2,3	QAXLWL-840H-L****-B*	QAXLBL-840H-L****-B*	1248,00

Opal Flex Diffuser | Direct

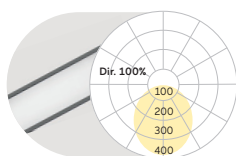

L mm	Colour Temperature	Control	Power	Lumen/Watt	Weight kg	Code Snow White/Jet Black	Code Jet Black/Jet Black	CHF
Liquid Line per meter (Lineare Teilstücke Straight Sections Sections droites)								
per meter	4000K	On/Off	Low	1110lm/11,1W	2,3	QAXCWE-840E-L****	QAXCBE-840E-L****	497,00
per meter	4000K	On/Off	Medium	1550lm/15,6W	2,3	QAXCWE-840M-L****	QAXCBE-840M-L****	497,00
per meter	4000K	On/Off	High	2150lm/21,8W	2,3	QAXCWE-840H-L****	QAXCBE-840H-L****	497,00
per meter	4000K	DALI	Low	1110lm/11,1W	2,3	QAXCWL-840E-L****	QAXCBL-840E-L****	567,00
per meter	4000K	DALI	Medium	1550lm/15,6W	2,3	QAXCWL-840M-L****	QAXCBL-840M-L****	567,00
per meter	4000K	DALI	High	2150lm/21,8W	2,3	QAXCWL-840H-L****	QAXCBL-840H-L****	567,00

Liquid Line per meter (Gebogene Teilstücke Curved and bent Sections Courbes Sections)								
per meter	4000K	On/Off	Low	1110lm/11,1W	2,3	QAXCWE-840E-L****	QAXCBE-840E-L****	847,00
per meter	4000K	On/Off	Medium	1550lm/15,6W	2,3	QAXCWE-840M-L****	QAXCBE-840M-L****	847,00
per meter	4000K	On/Off	High	2150lm/21,8W	2,3	QAXCWE-840H-L****	QAXCBE-840H-L****	847,00
per meter	4000K	DALI	Low	1110lm/11,1W	2,3	QAXCWL-840E-L****	QAXCBL-840E-L****	900,00
per meter	4000K	DALI	Medium	1550lm/15,6W	2,3	QAXCWL-840M-L****	QAXCBL-840M-L****	900,00
per meter	4000K	DALI	High	2150lm/21,8W	2,3	QAXCWL-840H-L****	QAXCBL-840H-L****	900,00

Liquid Line per meter (Wellenförmige Teilstücke Wave Sections Sections d'onde)								
per meter	4000K	On/Off	Low	1110lm/11,1W	2,3	QAXCWE-840E-L****	QAXCBE-840E-L****	2562,00
per meter	4000K	On/Off	Medium	1550lm/15,6W	2,3	QAXCWE-840M-L****	QAXCBE-840M-L****	2562,00
per meter	4000K	On/Off	High	2150lm/21,8W	2,3	QAXCWE-840H-L****	QAXCBE-840H-L****	2562,00
per meter	4000K	DALI	Low	1110lm/11,1W	2,3	QAXCWL-840E-L****	QAXCBL-840E-L****	2615,00
per meter	4000K	DALI	Medium	1550lm/15,6W	2,3	QAXCWL-840M-L****	QAXCBL-840M-L****	2615,00
per meter	4000K	DALI	High	2150lm/21,8W	2,3	QAXCWL-840H-L****	QAXCBL-840H-L****	2615,00

Zusätzlicher Preis per X-Junction Module | Additional Price per X-Junction Module | Prix supplémentaire par module X-Junction +412,00
Zusätzlicher Preis per Y-Junction Module | Additional Price per Y-Junction Module | Prix supplémentaire par module Y-Junction +359,00

**** Your length in mm
 Meterpreise für Lichtsysteme nach Maß ab Mindestlänge 2200mm | Prices per metre for customised lighting systems with a minimum length of 2200mm
 Prix au mètre pour systèmes d'éclairage sur mesure à partir d'une longueur minimale de 2200mm

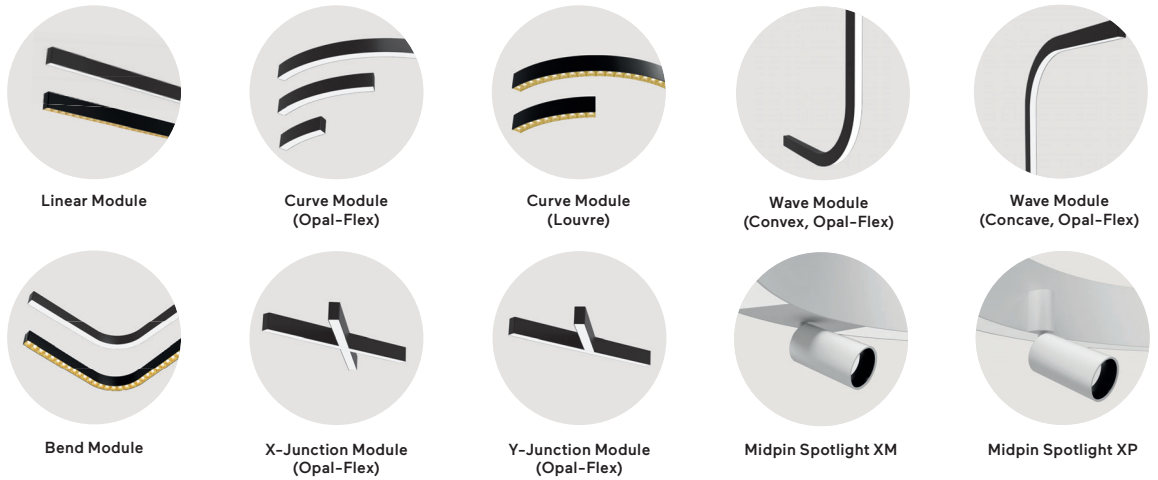

Surcharges

Surface Finish

Surface Finish	CHF
W: Snow White	✓
V: Ivory White	✓
A: Satin Silver	+15%
U: Urban Graphite	✓
B: Jet Black	✓
H: Anodic Champagne	+10%
K: Satin Copper	+15%
R: Special RAL/NCS Colours	ⓘ

Control Gear

Control Gear	CHF
E: On/Off	✓
L: DALI	✓
H: Touch-Dim	ⓘ
C: Casambi	ⓘ
Colour Rendering	CHF
8: CRI>80	✓
9: CRI>90	+5%
F: Full Spectrum	+15%

Colour Temperature

Colour Temperature	CHF
22: 2200K	+5%
27: 2700K	+5%
30: 3000K	✓
35: 3500K	+5%
40: 4000K	✓
65: 6500K	+5%

Reflector Colour

Reflector Colour	CHF
W: Snow White	✓
A: Satin Silver	✓
B: Jet Black	✓
H: Anodic Champagne	✓
K: Satin Copper	✓
G: Satin Gold	✓

Additional Options

Additional Options	CHF
Midpin Spotlight XM	+363,00
Midpin Spotlight XP	+433,00

✓ standard / no extra charge ⓘ on request ✗ not available

Liquid Line A3 | System 60mm Surface

catalogue page **382**



DE System aus linearen, vertikal und horizontal gebogenen Komponenten sowie Y- und X-Verbindungselementen. Auf Grundlage skizzierter Kundenvorgabe erstellt Lightnet technische Zeichnung der gewünschten Struktur zur Prüfung und Freigabe. Zeichnungen für mögliche Radien, X- und Y-Module siehe Katalog. Sonderradien möglich.

EN System consisting of linear elements, vertically and horizontally curved elements and Y- and X-connectors. Based on customer specification, Lightnet creates technical drawings of the desired structure for review and approval. For drawings of possible curves, X- and Y-modules, see catalog. Special curves possible for Opal-Flex diffuser.

FR Système d'éclairage sur-mesure des éléments/modules droits-linéaires, verticaux et horizontaux cintrés, tout comme des connections/jonctions en forme de Y et X. Sur la base des schémas et spécifications voulues par le client, Lightnet crée les dessins techniques de la structure sur-mesure souhaitée pour contrôle et validation avant mise en production. Pour les dessins des rayons possibles et des modules X et Y, voir le catalogue. Rayons spéciaux possibles pour les diffuseurs Opal-Flex.



Microprismatic | Direct

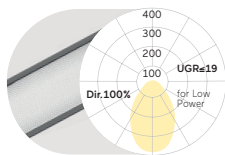

L mm	Colour Temperature	Control	Power	Lumen/Watt	Weight kg	Code Snow White	Code Jet Black	CHF
Liquid Line per meter (Lineare Teilstücke Straight Sections Sections droites)								
per meter	4000K	On/Off	Low	1200lm/14,6W	3,5	QA3AWE-840E-L****	QA3ABE-840E-L****	655,00
per meter	4000K	On/Off	Medium	1760lm/22,5W	3,5	QA3AWE-840M-L****	QA3ABE-840M-L****	655,00
per meter	4000K	On/Off	High	2290lm/30,3W	3,5	QA3AWE-840H-L****	QA3ABE-840H-L****	655,00
per meter	4000K	DALI	Low	1200lm/14,6W	3,5	QA3AWL-840E-L****	QA3ABL-840E-L****	707,00
per meter	4000K	DALI	Medium	1760lm/22,5W	3,5	QA3AWL-840M-L****	QA3ABL-840M-L****	707,00
per meter	4000K	DALI	High	2290lm/30,3W	3,5	QA3AWL-840H-L****	QA3ABL-840H-L****	707,00
Liquid Line per meter (Gebogene Teilstücke Curved and bent Sections Courbes Sections)								
per meter	4000K	On/Off	Low	1200lm/14,6W	3,5	QA3AWE-840E-L****	QA3ABE-840E-L****	1005,00
per meter	4000K	On/Off	Medium	1760lm/22,5W	3,5	QA3AWE-840M-L****	QA3ABE-840M-L****	1005,00
per meter	4000K	On/Off	High	2290lm/30,3W	3,5	QA3AWE-840H-L****	QA3ABE-840H-L****	1005,00
per meter	4000K	DALI	Low	1200lm/14,6W	3,5	QA3AWL-840E-L****	QA3ABL-840E-L****	1057,00
per meter	4000K	DALI	Medium	1760lm/22,5W	3,5	QA3AWL-840M-L****	QA3ABL-840M-L****	1057,00
per meter	4000K	DALI	High	2290lm/30,3W	3,5	QA3AWL-840H-L****	QA3ABL-840H-L****	1057,00
Liquid Line per meter (Wellenförmige Teilstücke Wave Sections Sections d'onde)								
per meter	4000K	On/Off	Low	1200lm/14,6W	3,5	QA3AWE-840E-L****	QA3ABE-840E-L****	2597,00
per meter	4000K	On/Off	Medium	1760lm/22,5W	3,5	QA3AWE-840M-L****	QA3ABE-840M-L****	2597,00
per meter	4000K	On/Off	High	2290lm/30,3W	3,5	QA3AWE-840H-L****	QA3ABE-840H-L****	2597,00
per meter	4000K	DALI	Low	1200lm/14,6W	3,5	QA3AWL-840E-L****	QA3ABL-840E-L****	2650,00
per meter	4000K	DALI	Medium	1760lm/22,5W	3,5	QA3AWL-840M-L****	QA3ABL-840M-L****	2650,00
per meter	4000K	DALI	High	2290lm/30,3W	3,5	QA3AWL-840H-L****	QA3ABL-840H-L****	2650,00

Zusätzlicher Preis per X-Junction Module | Additional Price per X-Junction Module | Prix supplémentaire par module X-Junction +412,00
Zusätzlicher Preis per Y-Junction Module | Additional Price per Y-Junction Module | Prix supplémentaire par module Y-Junction +359,00

Opal Diffuser | Direct

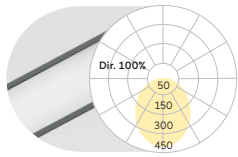

L mm	Colour Temperature	Control	Power	Lumen/Watt	Weight kg	Code Snow White	Code Jet Black	CHF
Liquid Line per meter (Lineare Teilstücke Straight Sections Sections droites)								
per meter	4000K	On/Off	Low	1300lm/14,6W	3,5	QA3OWE-840E-L****	QA3OBE-840E-L****	620,00
per meter	4000K	On/Off	Medium	1910lm/22,5W	3,5	QA3OWE-840M-L****	QA3OBE-840M-L****	620,00
per meter	4000K	On/Off	High	2480lm/30,3W	3,5	QA3OWE-840H-L****	QA3OBE-840H-L****	620,00
per meter	4000K	DALI	Low	1300lm/14,6W	3,5	QA3OWL-840E-L****	QA3OBL-840E-L****	672,00
per meter	4000K	DALI	Medium	1910lm/22,5W	3,5	QA3OWL-840M-L****	QA3OBL-840M-L****	672,00
per meter	4000K	DALI	High	2480lm/30,3W	3,5	QA3OWL-840H-L****	QA3OBL-840H-L****	672,00
Liquid Line per meter (Gebogene Teilstücke Curved and bent Sections Courbes Sections)								
per meter	4000K	On/Off	Low	1300lm/14,6W	3,5	QA3OWE-840E-L****	QA3OBE-840E-L****	970,00
per meter	4000K	On/Off	Medium	1910lm/22,5W	3,5	QA3OWE-840M-L****	QA3OBE-840M-L****	970,00
per meter	4000K	On/Off	High	2480lm/30,3W	3,5	QA3OWE-840H-L****	QA3OBE-840H-L****	970,00
per meter	4000K	DALI	Low	1300lm/14,6W	3,5	QA3OWL-840E-L****	QA3OBL-840E-L****	1022,00
per meter	4000K	DALI	Medium	1910lm/22,5W	3,5	QA3OWL-840M-L****	QA3OBL-840M-L****	1022,00
per meter	4000K	DALI	High	2480lm/30,3W	3,5	QA3OWL-840H-L****	QA3OBL-840H-L****	1022,00
Liquid Line per meter (Wellenförmige Teilstücke Wave Sections Sections d'onde)								
per meter	4000K	On/Off	Low	1300lm/14,6W	3,5	QA3OWE-840E-L****	QA3OBE-840E-L****	2562,00
per meter	4000K	On/Off	Medium	1910lm/22,5W	3,5	QA3OWE-840M-L****	QA3OBE-840M-L****	2562,00
per meter	4000K	On/Off	High	2480lm/30,3W	3,5	QA3OWE-840H-L****	QA3OBE-840H-L****	2562,00
per meter	4000K	DALI	Low	1300lm/14,6W	3,5	QA3OWL-840E-L****	QA3OBL-840E-L****	2615,00
per meter	4000K	DALI	Medium	1910lm/22,5W	3,5	QA3OWL-840M-L****	QA3OBL-840M-L****	2615,00
per meter	4000K	DALI	High	2480lm/30,3W	3,5	QA3OWL-840H-L****	QA3OBL-840H-L****	2615,00

Zusätzlicher Preis per X-Junction Module | Additional Price per X-Junction Module | Prix supplémentaire par module X-Junction +412,00
 Zusätzlicher Preis per Y-Junction Module | Additional Price per Y-Junction Module | Prix supplémentaire par module Y-Junction +359,00

**** Your length in mm
 Meterpreise für Lichtsysteme nach Maß ab Mindestlänge 2200mm | Prices per metre for customised lighting systems with a minimum length of 2200mm
 Prix au mètre pour systèmes d'éclairage sur mesure à partir d'une longueur minimale de 2200mm



Linear Module



Corner Module



Curve Module



Curve Module



Wave Module (convex)



Wave Module (concave)



Bend Module



Bend Module

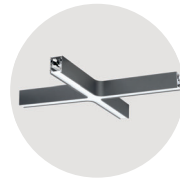

X-Junction Module

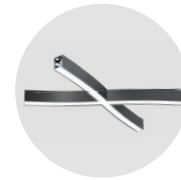

X-Junction Module

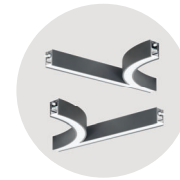

Y-Junction Module

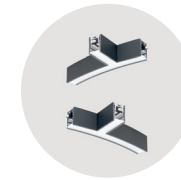

Y-Junction Module



Y-Junction Module



Y-Junction Module

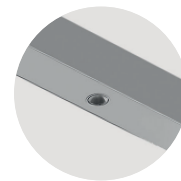

Midpin Downlight XD

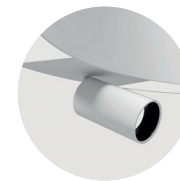

Midpin Spotlight XM



Midpin Spotlight XP



W Snow White

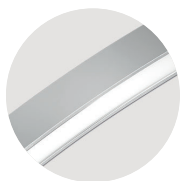

S Radiant Silver

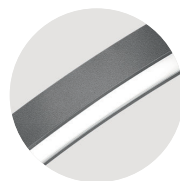

U Urban Graphite

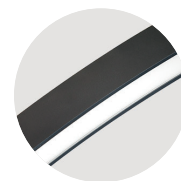

B Jet Black

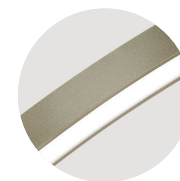

H Anodic Champagne

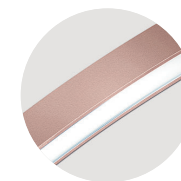

K Satin Copper

Surcharges

Surface Finish	CHF	Control Gear	CHF	Colour Rendering	CHF	Colour Temperature	CHF	Additional Options	CHF
W: Snow White	✓	E: On/Off	✓	8: CRI>80	✓	22: 2200K	+5%	Midpin Downlight XD	+363,00
V: Ivory White	✓	L: DALI	+86,00	9: CRI>90	+5%	27: 2700K	+5%	Midpin Spotlight XM	+363,00
A: Satin Silver	+15%	H: Touch-Dim	+86,00	F: Full Spectrum	+15%	30: 3000K	✓	Midpin Spotlight XP	+433,00
U: Urban Graphite	✓	C: Casambi*	+261,00			35: 3500K	+5%		
B: Jet Black	✓					40: 4000K	✓		
H: Anodic Champagne	+10%	*Only in combination with DALI. Please add to dimming price.				65: 6500K	+5%		
K: Satin Copper	+15%								
R: Special RAL/NCS Colours	ⓘ								

✓ standard / no extra charge ⓘ on request ✗ not available

Caleo Inverse AX | System 40mm Surface

catalogue page 386

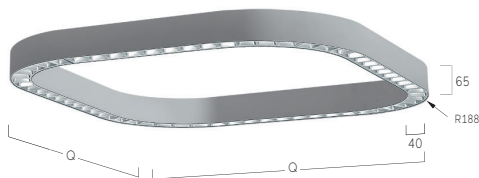

Lens Louvre | Direct

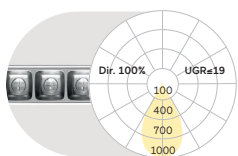

Q mm	Colour Temperature	Control	Power	Lumen/Watt	Weight kg	Code Snow White/Jet Black	Code Jet Black/Jet Black	CHF
640	4000K	On/Off	Low	3480lm/27W	6,0	AAXLWE-840E-Q640-B*	AAXLBE-840E-Q640-B*	2277,00
640	4000K	On/Off	High	6380lm/54W	6,0	AAXLWE-840H-Q640-B*	AAXLBE-840H-Q640-B*	2277,00
900	4000K	On/Off	Low	5220lm/39W	8,5	AAXLWE-840E-Q900-B*	AAXLBE-840E-Q900-B*	2627,00
900	4000K	On/Off	High	9580lm/78W	8,5	AAXLWE-840H-Q900-B*	AAXLBE-840H-Q900-B*	2627,00
1170	4000K	On/Off	Low	6960lm/51W	11,0	AAXLWE-840E-Q1170-B*	AAXLBE-840E-Q1170-B*	3100,00
1170	4000K	On/Off	High	12770lm/104W	11,0	AAXLWE-840H-Q1170-B*	AAXLBE-840H-Q1170-B*	3100,00

Opal Flex Diffuser | Direct

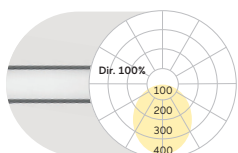

Q mm	Colour Temperature	Control	Power	Lumen/Watt	Weight kg	Code Snow White	Code Jet Black	CHF
640	4000K	On/Off	Medium	3190lm/34W	6,0	AAXCWE-840M-Q640	AAXCBE-840M-Q640	2015,00
640	4000K	On/Off	High	4460lm/50W	6,0	AAXCWE-840H-Q640	AAXCBE-840H-Q640	2015,00
900	4000K	On/Off	Medium	4710lm/49W	8,5	AAXCWE-840M-Q900	AAXCBE-840M-Q900	2277,00
900	4000K	On/Off	High	6630lm/72W	8,5	AAXCWE-840H-Q900	AAXCBE-840H-Q900	2277,00
1170	4000K	On/Off	Medium	6280lm/64W	11,0	AAXCWE-840M-Q1170	AAXCBE-840M-Q1170	2627,00
1170	4000K	On/Off	High	8840lm/95W	11,0	AAXCWE-840H-Q1170	AAXCBE-840H-Q1170	2627,00

Surcharges

Surface Finish

Finish	CHF
W: Snow White	✓
V: Ivory White	✓
A: Satin Silver	+15%
S: Radiant Silver	✓
U: Urban Graphite	✓
B: Jet Black	✓
H: Anodic Champagne	+10%
K: Satin Copper	+15%
R: Special RAL/NCS Colours	ⓘ

Control Gear

Control	CHF
E: On/Off	✓
H: Touch-Dim	+86,00
L: DALI	+86,00
C: Casambi*	+261,00

*Only in combination with DALI. Please add to dimming price.

Colour Rendering

CR	CHF
8: CRI>80	✓
9: CRI>90	+5%
F: Full Spectrum	+15%

Colour Temperature

Temp	CHF
22: 2200K	+5%
27: 2700K	+5%
30: 3000K	✓
35: 3500K	+5%
40: 4000K	✓
65: 6500K	+5%

Lens Louvre*

Finish	CHF
W: Snow White	✓
A: Satin Silver	✓
B: Jet Black	✓
H: Anodic Champagne	✓
G: Satin Gold	✓
K: Satin Copper	✓

Additional Options

Option	CHF
Midpin Spotlight XP	+433,00
Acoustic Absorber	ⓘ



Midpin Spotlight XP
770lm/10W/Ø40mm

✓ standard / no extra charge ⓘ on request ✗ not available

Caleo Neo Y4/X4 | Surface

catalogue page 388

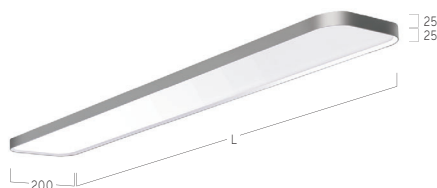

Microprismatic | Direct-Indirect

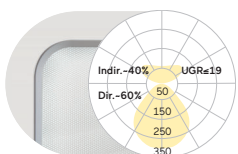

L mm	Colour Temperature	Control	Power	Lumen/Watt	Weight kg	Code Snow White	Code Radiant Silver	CHF
900	4000K	On/Off	Medium	3760lm/31W	4,8	AX4AWE-840M-L900-W	AX4ASE-840M-L900-S	832,00
900	4000K	On/Off	High	5070lm/40W	4,8	AX4AWE-840H-L900-W	AX4ASE-840H-L900-S	832,00
1200	4000K	On/Off	Medium	5010lm/39W	6,4	AX4AWE-840M-L1200-W	AX4ASE-840M-L1200-S	868,00
1200	4000K	On/Off	High	6810lm/52W	6,4	AX4AWE-840H-L1200-W	AX4ASE-840H-L1200-S	868,00
1500	4000K	On/Off	Medium	6480lm/49W	8,0	AX4AWE-840M-L1500-W	AX4ASE-840M-L1500-S	1061,00
1500	4000K	On/Off	High	8450lm/65W	8,0	AX4AWE-840H-L1500-W	AX4ASE-840H-L1500-S	1061,00

... Caleo Neo Y4/X4 | Surface

Microprismatic | Direct

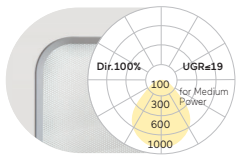

L mm	Colour Temperature	Control	Power	Lumen/Watt	Weight kg	Code Snow White	Code Radiant Silver	CHF
900	4000K	On/Off	Medium	2280lm/19W	4,5	AY4AWE-840M-L900-W	AY4ASE-840M-L900-S	748,00
900	4000K	On/Off	High	3150lm/27W	4,5	AY4AWE-840H-L900-W	AY4ASE-840H-L900-S	748,00
1200	4000K	On/Off	Medium	3040lm/24W	6,1	AY4AWE-840M-L1200-W	AY4ASE-840M-L1200-S	786,00
1200	4000K	On/Off	High	4260lm/34W	6,1	AY4AWE-840H-L1200-W	AY4ASE-840H-L1200-S	786,00
1500	4000K	On/Off	Medium	4020lm/32W	7,7	AY4AWE-840M-L1500-W	AY4ASE-840M-L1500-S	933,00
1500	4000K	On/Off	High	5260lm/42W	7,7	AY4AWE-840H-L1500-W	AY4ASE-840H-L1500-S	933,00

Opal Diffuser | Direct-Indirect

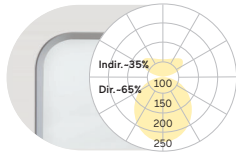

L mm	Colour Temperature	Control	Power	Lumen/Watt	Weight kg	Code Snow White	Code Radiant Silver	CHF
900	4000K	On/Off	Medium	3860lm/31W	4,8	AX4OWE-840M-L900-W	AX4OSE-840M-L900-S	814,00
900	4000K	On/Off	High	5210lm/40W	4,8	AX4OWE-840H-L900-W	AX4OSE-840H-L900-S	814,00
1200	4000K	On/Off	Medium	5140lm/39W	6,4	AX4OWE-840M-L1200-W	AX4OSE-840M-L1200-S	851,00
1200	4000K	On/Off	High	6930lm/52W	6,4	AX4OWE-840H-L1200-W	AX4OSE-840H-L1200-S	851,00
1500	4000K	On/Off	Medium	6610lm/49W	8,0	AX4OWE-840M-L1500-W	AX4OSE-840M-L1500-S	1022,00
1500	4000K	On/Off	High	8660lm/65W	8,0	AX4OWE-840H-L1500-W	AX4OSE-840H-L1500-S	1022,00

Opal Diffuser | Direct

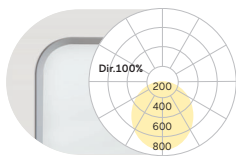

L mm	Colour Temperature	Control	Power	Lumen/Watt	Weight kg	Code Snow White	Code Radiant Silver	CHF
900	4000K	On/Off	Medium	2380lm/19W	4,5	AY4OWE-840M-L900-W	AY4OSE-840M-L900-S	730,00
900	4000K	On/Off	High	3290lm/27W	4,5	AY4OWE-840H-L900-W	AY4OSE-840H-L900-S	730,00
1200	4000K	On/Off	Medium	3170lm/24W	6,1	AY4OWE-840M-L1200-W	AY4OSE-840M-L1200-S	767,00
1200	4000K	On/Off	High	4380lm/34W	6,1	AY4OWE-840H-L1200-W	AY4OSE-840H-L1200-S	767,00
1500	4000K	On/Off	Medium	4150lm/32W	7,7	AY4OWE-840M-L1500-W	AY4OSE-840M-L1500-S	896,00
1500	4000K	On/Off	High	5470lm/42W	7,7	AY4OWE-840H-L1500-W	AY4OSE-840H-L1500-S	896,00

Surcharges

Surface / Reflector Finish

Uni-Colours

W...W: Snow White / Snow White	✓	CHF
V...V: Ivory White / Ivory White	✓	
S...S: Radiant Silver / Radiant Silver	✓	
U...U: Urban Graphite / Urban Graphite	✓	
B...B: Jet Black / Jet Black	✓	
H...H: Anodic Champ. / Anodic Champ.	+5%	
K...K: Satin Copper / Satin Copper	+15%	

Surface / Reflector Finish

Dual Colours

W...G: Snow White / Satin Gold	+15%
W...K: Snow White / Satin Copper	+15%
W...B: Snow White / Jet Black	+15%
H...B: Anodic Champ./ Jet Black	+15%
B...G: Jet Black / Satin Gold	+15%
B...W: Jet Black / Snow White	+15%

Control Gear

E: On/Off	✓	CHF
H: Touch-Dim	+86,00	
L: DALI	+86,00	
C: Casambi*	+261,00	

*Only in combination with DALI. Please add to dimming price.

Colour Rendering

8: CRI>80	✓	CHF
9: CRI>90	+5%	
F: Full Spectrum	+15%	

Colour Temperature

22: 2200K	+5%
27: 2700K	+5%
30: 3000K	✓
35: 3500K	+5%
40: 4000K	✓
65: 6500K	+5%

✓ standard / no extra charge ⚡ on request ✖ not available

Caleo Neo Y6/X6 | Surface

catalogue page 390

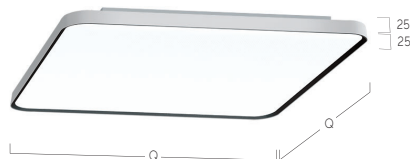

Microprismatic | Direct-Indirect

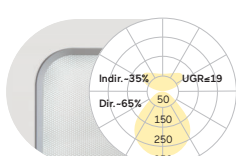

Q mm	Colour Temperature	Control	Power	Lumen/Watt	Weight kg	Code Snow White	Code Radiant Silver	CHF
300	4000K	On/Off	Medium	1990lm/17W	2,2	AX6AWE-840M-Q300-W	AX6ASE-840M-Q300-S	856,00
300	4000K	On/Off	High	2700lm/22W	2,2	AX6AWE-840H-Q300-W	AX6ASE-840H-Q300-S	856,00
400	4000K	On/Off	Medium	2930lm/23W	3,9	AX6AWE-840M-Q400-W	AX6ASE-840M-Q400-S	994,00
400	4000K	On/Off	High	3890lm/31W	3,9	AX6AWE-840H-Q400-W	AX6ASE-840H-Q400-S	994,00
500	4000K	On/Off	Medium	5140lm/39W	6,1	AX6AWE-840M-Q500-W	AX6ASE-840M-Q500-S	1122,00
500	4000K	On/Off	High	6720lm/52W	6,1	AX6AWE-840H-Q500-W	AX6ASE-840H-Q500-S	1122,00
600	4000K	On/Off	Medium	6790lm/54W	7,1	AX6AWE-840M-Q600-W	AX6ASE-840M-Q600-S	1278,00
600	4000K	On/Off	High	9230lm/73W	7,1	AX6AWE-840H-Q600-W	AX6ASE-840H-Q600-S	1278,00

Microprismatic | Direct

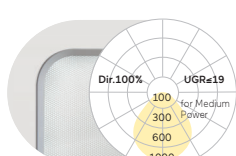

Q mm	Colour Temperature	Control	Power	Lumen/Watt	Weight kg	Code Snow White	Code Radiant Silver	CHF
300	4000K	On/Off	Medium	1230lm/11W	2,1	AY6AWE-840M-Q300-W	AY6ASE-840M-Q300-S	739,00
300	4000K	On/Off	High	1670lm/15W	2,1	AY6AWE-840H-Q300-W	AY6ASE-840H-Q300-S	739,00
400	4000K	On/Off	Medium	2060lm/18W	3,8	AY6AWE-840M-Q400-W	AY6ASE-840M-Q400-S	839,00
400	4000K	On/Off	High	2720lm/23W	3,8	AY6AWE-840H-Q400-W	AY6ASE-840H-Q400-S	839,00
500	4000K	On/Off	Medium	3180lm/26W	5,9	AY6AWE-840M-Q500-W	AY6ASE-840M-Q500-S	1003,00
500	4000K	On/Off	High	4180lm/35W	5,9	AY6AWE-840H-Q500-W	AY6ASE-840H-Q500-S	1003,00
600	4000K	On/Off	Medium	4800lm/39W	7,0	AY6AWE-840M-Q600-W	AY6ASE-840M-Q600-S	1122,00
600	4000K	On/Off	High	6480lm/53W	7,0	AY6AWE-840H-Q600-W	AY6ASE-840H-Q600-S	1122,00

Opal Diffuser | Direct-Indirect

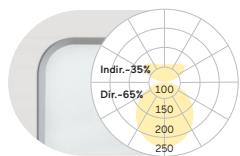

Q mm	Colour Temperature	Control	Power	Lumen/Watt	Weight kg	Code Snow White	Code Radiant Silver	CHF
300	4000K	On/Off	Medium	2000lm/17W	2,2	AX6OWE-840M-Q300-W	AX6OSE-840M-Q300-S	839,00
300	4000K	On/Off	High	2720lm/22W	2,2	AX6OWE-840H-Q300-W	AX6OSE-840H-Q300-S	839,00
400	4000K	On/Off	Medium	2950lm/23W	3,9	AX6OWE-840M-Q400-W	AX6OSE-840M-Q400-S	954,00
400	4000K	On/Off	High	3910lm/31W	3,9	AX6OWE-840H-Q400-W	AX6OSE-840H-Q400-S	954,00
500	4000K	On/Off	Medium	5170lm/39W	6,1	AX6OWE-840M-Q500-W	AX6OSE-840M-Q500-S	1080,00
500	4000K	On/Off	High	6760lm/52W	6,1	AX6OWE-840H-Q500-W	AX6OSE-840H-Q500-S	1080,00
600	4000K	On/Off	Medium	6830lm/54W	7,1	AX6OWE-840M-Q600-W	AX6OSE-840M-Q600-S	1220,00
600	4000K	On/Off	High	9290lm/73W	7,1	AX6OWE-840H-Q600-W	AX6OSE-840H-Q600-S	1220,00

Opal Diffuser | Direct

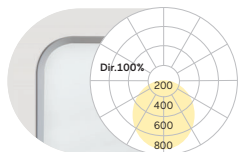

Q mm	Colour Temperature	Control	Power	Lumen/Watt	Weight kg	Code Snow White	Code Radiant Silver	CHF
300	4000K	On/Off	Medium	1240lm/11W	2,1	AY6OWE-840M-Q300-W	AY6OSE-840M-Q300-S	721,00
300	4000K	On/Off	High	1690lm/15W	2,1	AY6OWE-840H-Q300-W	AY6OSE-840H-Q300-S	721,00
400	4000K	On/Off	Medium	2080lm/18W	3,8	AY6OWE-840M-Q400-W	AY6OSE-840M-Q400-S	798,00
400	4000K	On/Off	High	2740lm/23W	3,8	AY6OWE-840H-Q400-W	AY6OSE-840H-Q400-S	798,00
500	4000K	On/Off	Medium	3210lm/26W	5,9	AY6OWE-840M-Q500-W	AY6OSE-840M-Q500-S	965,00
500	4000K	On/Off	High	4220lm/35W	5,9	AY6OWE-840H-Q500-W	AY6OSE-840H-Q500-S	965,00
600	4000K	On/Off	Medium	4840lm/39W	7,0	AY6OWE-840M-Q600-W	AY6OSE-840M-Q600-S	1063,00
600	4000K	On/Off	High	6540lm/53W	7,0	AY6OWE-840H-Q600-W	AY6OSE-840H-Q600-S	1063,00

Surcharges

Surface / Reflector Finish

Uni-Colours

Surface / Reflector Finish	CHF
W...W: Snow White / Snow White	✓
V...V: Ivory White / Ivory White	✓
S...S: Radiant Silver / Radiant Silver	✓
U...U: Urban Graphite / Urban Graphite	✓
B...B: Jet Black / Jet Black	✓
H...H: Anodic Champ. / Anodic Champ.	+5%
K...K: Satin Copper / Satin Copper	+15%

Surface / Reflector Finish

Dual Colours

Surface / Reflector Finish	CHF
W...G: Snow White / Satin Gold	+15%
W...K: Snow White / Satin Copper	+15%
W...B: Snow White / Jet Black	+15%
H...B: Anodic Champ. / Jet Black	+15%
B...G: Jet Black / Satin Gold	+15%
B...W: Jet Black / Snow White	+15%

Control Gear

Control Gear	CHF
E: On/Off	✓
H: Touch-Dim	+86,00
L: DALI	+86,00
C: Casambi*	+261,00

*Only in combination with DALI. Please add to dimming price.

Colour Rendering

Colour Rendering	CHF
8: CRI>80	✓
9: CRI>90	+5%
F: Full Spectrum	+15%

Colour Temperature

Colour Temperature	CHF
22: 2200K	+5%
27: 2700K	+5%
30: 3000K	✓
35: 3500K	+5%
40: 4000K	✓
65: 6500K	+5%

✓ standard / no extra charge ⚠ on request ✗ not available

Cubic Evolution Y4/X4 | 200mm Surface

catalogue page 392

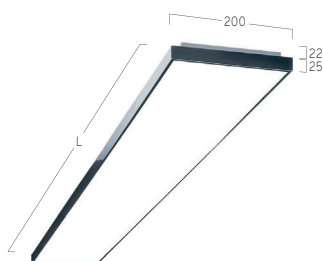

Microprismatic | Direct-Indirect

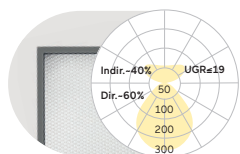

L mm	Colour Temperature	Control	Power	Lumen/Watt	Weight kg	Code Snow White	Code Silver Anodised	CHF
900	4000K	On/Off	Medium	3790lm/30W	5,0	CX4AWE-840M-L900	CX4AEE-840M-L900	753,00
900	4000K	On/Off	High	5000lm/40W	5,0	CX4AWE-840H-L900	CX4AEE-840H-L900	753,00
1200	4000K	On/Off	Medium	5020lm/39W	6,3	CX4AWE-840M-L1200	CX4AEE-840M-L1200	788,00
1200	4000K	On/Off	High	6560lm/52W	6,3	CX4AWE-840H-L1200	CX4AEE-840H-L1200	788,00
1500	4000K	On/Off	Medium	6160lm/48W	7,7	CX4AWE-840M-L1500	CX4AEE-840M-L1500	963,00
1500	4000K	On/Off	High	8270lm/65W	7,7	CX4AWE-840H-L1500	CX4AEE-840H-L1500	963,00

Microprismatic | Direct

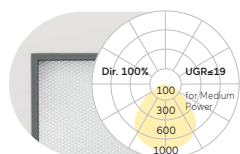

L mm	Colour Temperature	Control	Power	Lumen/Watt	Weight kg	Code Snow White	Code Silver Anodised	CHF
900	4000K	On/Off	Medium	2280lm/21W	5,2	CY4AWE-840M-L900	CY4AEE-840M-L900	700,00
900	4000K	On/Off	High	2930lm/26W	5,2	CY4AWE-840H-L900	CY4AEE-840H-L900	700,00
1200	4000K	On/Off	Medium	3050lm/27W	6,0	CY4AWE-840M-L1200	CY4AEE-840M-L1200	735,00
1200	4000K	On/Off	High	3900lm/34W	6,0	CY4AWE-840H-L1200	CY4AEE-840H-L1200	735,00
1500	4000K	On/Off	Medium	3700lm/32W	7,6	CY4AWE-840M-L1500	CY4AEE-840M-L1500	875,00
1500	4000K	On/Off	High	4880lm/43W	7,6	CY4AWE-840H-L1500	CY4AEE-840H-L1500	875,00

... Cubic Evolution Y4/X4 | 200mm Surface

Opal Diffuser | Direct-Indirect

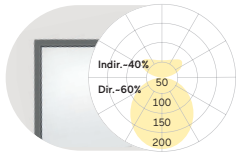

L mm	Colour Temperature	Control	Power	Lumen/Watt	Weight kg	Code Snow White	Code Silver Anodised	CHF
900	4000K	On/Off	Medium	3750lm/30W	5,0	CX4OWE-840M-L900	CX4OEE-840M-L900	735,00
900	4000K	On/Off	High	4950lm/40W	5,0	CX4OWE-840H-L900	CX4OEE-840H-L900	735,00
1200	4000K	On/Off	Medium	4930lm/39W	6,3	CX4OWE-840M-L1200	CX4OEE-840M-L1200	770,00
1200	4000K	On/Off	High	6510lm/52W	6,3	CX4OWE-840H-L1200	CX4OEE-840H-L1200	770,00
1500	4000K	On/Off	Medium	6090lm/48W	7,7	CX4OWE-840M-L1500	CX4OEE-840M-L1500	928,00
1500	4000K	On/Off	High	8160lm/65W	7,7	CX4OWE-840H-L1500	CX4OEE-840H-L1500	928,00

Opal Diffuser | Direct

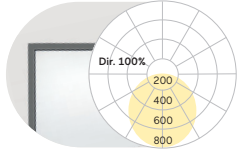

L mm	Colour Temperature	Control	Power	Lumen/Watt	Weight kg	Code Snow White	Code Silver Anodised	CHF
900	4000K	On/Off	Medium	2170lm/21W	5,2	CY4OWE-840M-L900	CY4OEE-840M-L900	683,00
900	4000K	On/Off	High	2730lm/26W	5,2	CY4OWE-840H-L900	CY4OEE-840H-L900	683,00
1200	4000K	On/Off	Medium	2890lm/27W	6,0	CY4OWE-840M-L1200	CY4OEE-840M-L1200	718,00
1200	4000K	On/Off	High	3650lm/34W	6,0	CY4OWE-840H-L1200	CY4OEE-840H-L1200	718,00
1500	4000K	On/Off	Medium	3460lm/32W	7,6	CY4OWE-840M-L1500	CY4OEE-840M-L1500	840,00
1500	4000K	On/Off	High	4560lm/43W	7,6	CY4OWE-840H-L1500	CY4OEE-840H-L1500	840,00

Surcharges

Surface Finish	CHF	Control Gear	CHF	Colour Rendering	CHF	Colour Temperature	CHF	Additional Options	CHF
W: Snow White	✓	E: On/Off	✓	8: CRI>80	✓	22: 2200K	+5%	Emergency Module [DALI, Autotest, incl. 3H Battery] [L1200-L1500]	+366,00
E: Silver Anodised	✓	L: DALI	+86,00	9: CRI>90	+5%	27: 2700K	+5%	Multisensor	+261,00
U: Urban Graphite	✓	H: Touch-Dim	+86,00	F: Full Spectrum	+15%	30: 3000K	✓		
B: Jet Black	✓	C: Casambi	+261,00			35: 3500K	+5%		
H: Anodic Champagne	+10%	6: DALI DT6 for TW	+172,00			40: 4000K	✓		
R: Special RAL/NCS Colours	ⓘ	8: DALI DT8 for TW	+172,00			65: 6500K	+5%		
		Only in combination with DALI. Please add to dimming price.				TW: Tunable White 2700-6500K	+30%		
						*Only in combination with DT6, DT8 or Casambi control. Please add additional control price.			

✓ standard / no extra charge
ⓘ on request
✗ not available

Cubic Evolution Y5/X5 | 200mm Surface

catalogue page **286**

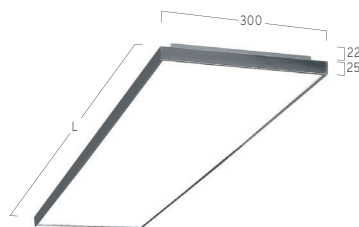

Microprismatic | Direct-Indirect

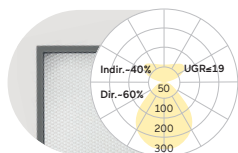

L mm	Colour Temperature	Control	Power	Lumen/Watt	Weight kg	Code Snow White	Code Silver Anodised	CHF
900	4000K	On/Off	Medium	5220lm/39W	5,8	CX5AWE-840M-L900	CX5AEE-840M-L900	916,00
900	4000K	On/Off	High	7430lm/55W	5,8	CX5AWE-840H-L900	CX5AEE-840H-L900	916,00
1200	4000K	On/Off	Medium	6990lm/51W	8,0	CX5AWE-840M-L1200	CX5AEE-840M-L1200	1026,00
1200	4000K	On/Off	High	9910lm/74W	8,0	CX5AWE-840H-L1200	CX5AEE-840H-L1200	1026,00
1500	4000K	On/Off	Medium	8590lm/62W	10,2	CX5AWE-840M-L1500	CX5AEE-840M-L1500	1267,00
1500	4000K	On/Off	High	12350lm/91W	10,2	CX5AWE-840H-L1500	CX5AEE-840H-L1500	1267,00

Microprismatic | Direct

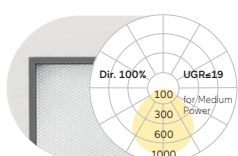

L mm	Colour Temperature	Control	Power	Lumen/Watt	Weight kg	Code Snow White	Code Silver Anodised	CHF
900	4000K	On/Off	Medium	3220lm/25W	5,8	CY5AWE-840M-L900	CY5AEE-840M-L900	840,00
900	4000K	On/Off	High	4600lm/35W	5,8	CY5AWE-840H-L900	CY5AEE-840H-L900	840,00
1200	4000K	On/Off	Medium	4290lm/33W	7,9	CY5AWE-840M-L1200	CY5AEE-840M-L1200	896,00
1200	4000K	On/Off	High	6140lm/48W	7,9	CY5AWE-840H-L1200	CY5AEE-840H-L1200	896,00
1500	4000K	On/Off	Medium	5370lm/40W	10,2	CY5AWE-840M-L1500	CY5AEE-840M-L1500	1101,00
1500	4000K	On/Off	High	7670lm/59W	10,2	CY5AWE-840H-L1500	CY5AEE-840H-L1500	1101,00

Opal Diffuser | Direct-Indirect

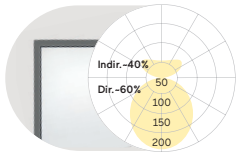

L mm	Colour Temperature	Control	Power	Lumen/Watt	Weight kg	Code Snow White	Code Silver Anodised	CHF
900	4000K	On/Off	Medium	5030lm/39W	5,8	CX50WE-840M-L900	CX50EE-840M-L900	879,00
900	4000K	On/Off	High	7140lm/55W	5,8	CX50WE-840H-L900	CX50EE-840H-L900	879,00
1200	4000K	On/Off	Medium	6740lm/51W	8,0	CX50WE-840M-L1200	CX50EE-840M-L1200	972,00
1200	4000K	On/Off	High	9510lm/74W	8,0	CX50WE-840H-L1200	CX50EE-840H-L1200	972,00
1500	4000K	On/Off	Medium	8270lm/62W	10,2	CX50WE-840M-L1500	CX50EE-840M-L1500	1211,00
1500	4000K	On/Off	High	11850lm/91W	10,2	CX50WE-840H-L1500	CX50EE-840H-L1500	1211,00

Opal Diffuser | Direct

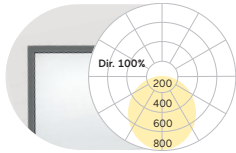

L mm	Colour Temperature	Control	Power	Lumen/Watt	Weight kg	Code Snow White	Code Silver Anodised	CHF
900	4000K	On/Off	Medium	3030lm/25W	5,8	CY50WE-840M-L900	CY50EE-840M-L900	804,00
900	4000K	On/Off	High	4310lm/35W	5,8	CY50WE-840H-L900	CY50EE-840H-L900	804,00
1200	4000K	On/Off	Medium	4040lm/33W	7,9	CY50WE-840M-L1200	CY50EE-840M-L1200	840,00
1200	4000K	On/Off	High	5740lm/48W	7,9	CY50WE-840H-L1200	CY50EE-840H-L1200	840,00
1500	4000K	On/Off	Medium	5050lm/40W	10,2	CY50WE-840M-L1500	CY50EE-840M-L1500	1045,00
1500	4000K	On/Off	High	7170lm/59W	10,2	CY50WE-840H-L1500	CY50EE-840H-L1500	1045,00

Surcharges

Surface Finish	CHF	Control Gear	CHF	Colour Rendering	CHF	Colour Temperature	CHF	Additional Options	CHF
W: Snow White	✓	E: On/Off	✓	8: CRI>80	✓	22: 2200K	+5%	Emergency Module [DALI, Autotest, incl. 3H Battery] [L1200-L1500]	+366,00
E: Silver Anodised	✓	L: DALI	+86,00	9: CRI>90	+5%	27: 2700K	+5%	Multisensor	+261,00
U: Urban Graphite	✓	H: Touch-Dim	+86,00	F: Full Spectrum	+15%	30: 3000K	✓		
B: Jet Black	✓	C: Casambi	+261,00			35: 3500K	+5%		
H: Anodic Champagne	+10%	6: DALI DT6 for TW	+172,00			40: 4000K	✓		
R: Special RAL/NCS Colours	🕒	8: DALI DT8 for TW	+172,00			65: 6500K	+5%		
						TW: Tunable White 2700-6500K*	+30%		

*Only in combination with DALI. Please add to dimming price.

*Only in combination with DT6, DT8 or Casambi control. Please add additional control price.

✓ standard / no extra charge 🕒 on request ✗ not available

Cubic Evolution Y6/X6 | Square Surface

catalogue page 288



Microprismatic | Direct-Indirect

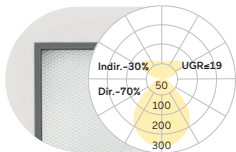

Q mm	Colour Temperature	Control	Power	Lumen/Watt	Weight kg	Code Snow White	Code Silver Anodised	CHF
300	4000K	On/Off	Medium	1970lm/16W	2,7	CX6AWE-840M-Q300	CX6AEE-840M-Q300	807,00
300	4000K	On/Off	High	2850lm/24W	2,7	CX6AWE-840H-Q300	CX6AEE-840H-Q300	807,00
400	4000K	On/Off	Medium	2920lm/23W	4,4	CX6AWE-840M-Q400	CX6AEE-840M-Q400	937,00
400	4000K	On/Off	High	4170lm/32W	4,4	CX6AWE-840H-Q400	CX6AEE-840H-Q400	937,00
500	4000K	On/Off	Medium	4580lm/33W	6,7	CX6AWE-840M-Q500	CX6AEE-840M-Q500	1057,00
500	4000K	On/Off	High	5900lm/44W	6,7	CX6AWE-840H-Q500	CX6AEE-840H-Q500	1057,00
600	4000K	On/Off	Medium	7240lm/55W	7,6	CX6AWE-840M-Q600	CX6AEE-840M-Q600	1204,00
600	4000K	On/Off	High	9850lm/76W	7,6	CX6AWE-840H-Q600	CX6AEE-840H-Q600	1204,00
800	4000K	On/Off	Medium	10590lm/76W	9,0	CX6AWE-840M-Q800	CX6AEE-840M-Q800	2246,00
800	4000K	On/Off	High	14950lm/109W	9,0	CX6AWE-840H-Q800	CX6AEE-840H-Q800	2246,00

Microprismatic | Direct

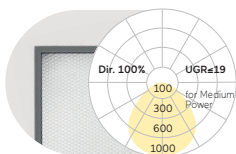

Q mm	Colour Temperature	Control	Power	Lumen/Watt	Weight kg	Code Snow White	Code Silver Anodised	CHF
300	4000K	On/Off	Medium	1210lm/11W	2,6	CY6AWE-840M-Q300	CY6AEE-840M-Q300	697,00
300	4000K	On/Off	High	1740lm/16W	2,6	CY6AWE-840H-Q300	CY6AEE-840H-Q300	697,00
400	4000K	On/Off	Medium	1960lm/16W	4,3	CY6AWE-840M-Q400	CY6AEE-840M-Q400	790,00
400	4000K	On/Off	High	2860lm/24W	4,3	CY6AWE-840H-Q400	CY6AEE-840H-Q400	790,00
500	4000K	On/Off	Medium	3330lm/26W	6,5	CY6AWE-840M-Q500	CY6AEE-840M-Q500	945,00
500	4000K	On/Off	High	4290lm/34W	6,5	CY6AWE-840H-Q500	CY6AEE-840H-Q500	945,00
600	4000K	On/Off	Medium	5250lm/40W	7,5	CY6AWE-840M-Q600	CY6AEE-840M-Q600	1057,00
600	4000K	On/Off	High	7100lm/55W	7,5	CY6AWE-840H-Q600	CY6AEE-840H-Q600	1057,00
800	4000K	On/Off	Medium	7590lm/55W	9,0	CY6AWE-840M-Q800	CY6AEE-840M-Q800	2058,00
800	4000K	On/Off	High	10630lm/78W	9,0	CY6AWE-840H-Q800	CY6AEE-840H-Q800	2058,00

... Cubic Evolution Y6/X6 | Square Surface

Opal Diffuser | Direct-Indirect

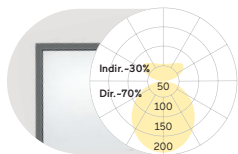

Q mm	Colour Temperature	Control	Power	Lumen/Watt	Weight kg	Code Snow White	Code Silver Anodised	CHF
300	4000K	On/Off	Medium	1930lm/16W	2,7	CX6OWE-840M-Q300	CX6OEE-840M-Q300	790,00
300	4000K	On/Off	High	2760lm/24W	2,7	CX6OWE-840H-Q300	CX6OEE-840H-Q300	790,00
400	4000K	On/Off	Medium	2870lm/23W	4,4	CX6OWE-840M-Q400	CX6OEE-840M-Q400	900,00
400	4000K	On/Off	High	4120lm/32W	4,4	CX6OWE-840H-Q400	CX6OEE-840H-Q400	900,00
500	4000K	On/Off	Medium	4550lm/33W	6,7	CX6OWE-840M-Q500	CX6OEE-840M-Q500	1019,00
500	4000K	On/Off	High	5880lm/44W	6,7	CX6OWE-840H-Q500	CX6OEE-840H-Q500	1019,00
600	4000K	On/Off	Medium	7170lm/55W	7,6	CX6OWE-840M-Q600	CX6OEE-840M-Q600	1150,00
600	4000K	On/Off	High	9750lm/76W	7,6	CX6OWE-840H-Q600	CX6OEE-840H-Q600	1150,00
800	4000K	On/Off	Medium	10370lm/76W	9,0	CX6OWE-840M-Q800	CX6OEE-840M-Q800	2190,00
800	4000K	On/Off	High	14440lm/109W	9,0	CX6OWE-840H-Q800	CX6OEE-840H-Q800	2190,00

Opal Diffuser | Direct

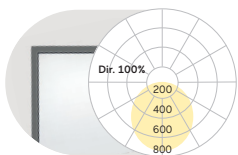

Q mm	Colour Temperature	Control	Power	Lumen/Watt	Weight kg	Code Snow White	Code Silver Anodised	CHF
300	4000K	On/Off	Medium	1170lm/11W	2,6	CY6OWE-840M-Q300	CY6OEE-840M-Q300	679,00
300	4000K	On/Off	High	1650lm/16W	2,6	CY6OWE-840H-Q300	CY6OEE-840H-Q300	679,00
400	4000K	On/Off	Medium	1910lm/16W	4,3	CY6OWE-840M-Q400	CY6OEE-840M-Q400	753,00
400	4000K	On/Off	High	2810lm/24W	4,3	CY6OWE-840H-Q400	CY6OEE-840H-Q400	753,00
500	4000K	On/Off	Medium	3300lm/26W	6,5	CY6OWE-840M-Q500	CY6OEE-840M-Q500	909,00
500	4000K	On/Off	High	4270lm/34W	6,5	CY6OWE-840H-Q500	CY6OEE-840H-Q500	909,00
600	4000K	On/Off	Medium	5180lm/40W	7,5	CY6OWE-840M-Q600	CY6OEE-840M-Q600	1001,00
600	4000K	On/Off	High	7000lm/55W	7,5	CY6OWE-840H-Q600	CY6OEE-840H-Q600	1001,00
800	4000K	On/Off	Medium	7370lm/55W	9,0	CY6OWE-840M-Q800	CY6OEE-840M-Q800	2002,00
800	4000K	On/Off	High	10120lm/78W	9,0	CY6OWE-840H-Q800	CY6OEE-840H-Q800	2002,00

Surcharges

Surface Finish	CHF	Control Gear	CHF	CHF	Colour Rendering	CHF	Colour Temperature	CHF	Additional Options	CHF
W: Snow White	✓	E: On/Off	✓	Q300-Q600	8: CRI>80	✓	22: 2200K	+5%	Emergency Module [DALI, Autotest, incl. 3H Battery] [Q400-Q800]	+366,00
E: Silver Anodised	✓	L: DALI	+86,00	Q800	9: CRI>90	+5%	27: 2700K	+5%	Multisensor	+261,00
U: Urban Graphite	✓	H: Touch-Dim	+86,00		F: Full Spectrum	+15%	30: 3000K	✓		
B: Jet Black	✓	C: Casambi*	+261,00				35: 3500K	+5%		
H: Anodic Champagne	+10%	6: DALI DT6 for TW	+172,00				40: 4000K	✓		
R: Special RAL/NCS Colours	⚡	8: DALI DT8 for TW	+172,00				65: 6500K	+5%		
							TW: Tunable White 2700-6500K* [Q400-Q800]	+30%		

✓ standard / no extra charge ⚡ on request ✗ not available

*Only in combination with DALI. Please add to dimming price.

*Only in combination with DT6,DT8 or Casambi control. Please add additional control price.

Cubic Neo A9 | Surface

catalogue page **398**

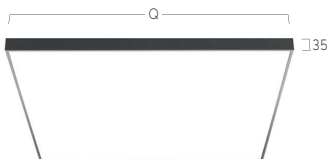
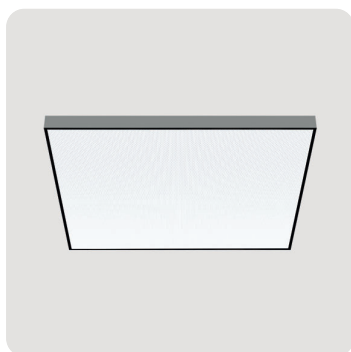

Microprismatic | Direct

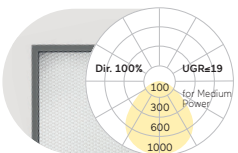

Q mm	Colour Temperature	Control	Power	Lumen/Watt	Weight kg	Code Snow White	Code Silver Anodised	CHF
300	4000K	On/Off	Medium	1210lm/11W	2,6	CA9AWE-840M-Q300	CA9AEE-840M-Q300	613,00
300	4000K	On/Off	High	1740lm/16W	2,6	CA9AWE-840H-Q300	CA9AEE-840H-Q300	613,00
400	4000K	On/Off	Medium	1960lm/16W	4,2	CA9AWE-840M-Q400	CA9AEE-840M-Q400	755,00
400	4000K	On/Off	High	2860lm/24W	4,2	CA9AWE-840H-Q400	CA9AEE-840H-Q400	755,00
500	4000K	On/Off	Medium	3330lm/26W	6,2	CA9AWE-840M-Q500	CA9AEE-840M-Q500	891,00
500	4000K	On/Off	High	4290lm/34W	6,2	CA9AWE-840H-Q500	CA9AEE-840H-Q500	891,00
600	4000K	On/Off	Medium	5250lm/40W	7,6	CA9AWE-840M-Q600	CA9AEE-840M-Q600	994,00
600	4000K	On/Off	High	7100lm/55W	7,6	CA9AWE-840H-Q600	CA9AEE-840H-Q600	994,00
800	4000K	On/Off	Medium	7590lm/55W	9,0	CA9AWE-840M-Q800	CA9AEE-840M-Q800	2211,00
800	4000K	On/Off	High	10630lm/78W	9,0	CA9AWE-840H-Q800	CA9AEE-840H-Q800	2211,00

Opal Diffuser | Direct

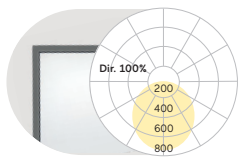

Q mm	Colour Temperature	Control	Power	Lumen/Watt	Weight kg	Code Snow White	Code Silver Anodised	CHF
300	4000K	On/Off	Medium	1170lm/11W	2,6	CA9OWE-840M-Q300	CA9OEE-840M-Q300	573,00
300	4000K	On/Off	High	1650lm/16W	2,6	CA9OWE-840H-Q300	CA9OEE-840H-Q300	573,00
400	4000K	On/Off	Medium	1910lm/16W	4,2	CA9OWE-840M-Q400	CA9OEE-840M-Q400	713,00
400	4000K	On/Off	High	2810lm/24W	4,2	CA9OWE-840H-Q400	CA9OEE-840H-Q400	713,00
500	4000K	On/Off	Medium	3300lm/26W	6,2	CA9OWE-840M-Q500	CA9OEE-840M-Q500	830,00
500	4000K	On/Off	High	4270lm/34W	6,2	CA9OWE-840H-Q500	CA9OEE-840H-Q500	830,00
600	4000K	On/Off	Medium	5180lm/40W	7,6	CA9OWE-840M-Q600	CA9OEE-840M-Q600	910,00
600	4000K	On/Off	High	7000lm/55W	7,6	CA9OWE-840H-Q600	CA9OEE-840H-Q600	910,00
800	4000K	On/Off	Medium	7370lm/55W	9,0	CA9OWE-840M-Q800	CA9OEE-840M-Q800	2148,00
800	4000K	On/Off	High	10120lm/78W	9,0	CA9OWE-840H-Q800	CA9OEE-840H-Q800	2148,00

Surcharges

Surface Finish	CHF	Control Gear	CHF	Colour Rendering	CHF	Colour Temperature	CHF	Additional Options	CHF
W: Snow White	✓	E: On/Off	✓	8: CRI>80	✓	22: 2200K	+5%	Emergency Module [DALI, Autotest, incl. 3H Battery]	+366,00
E: Silver Anodised	✓	L: DALI	+86,00	9: CRI>90	+5%	27: 2700K	+5%	[Q400-Q800]	
U: Urban Graphite	✓	H: Touch-Dim	+86,00	F: Full Spectrum	+15%	30: 3000K	✓	Multisensor	+261,00
B: Jet Black	✓	C: Casambi*	+261,00			35: 3500K	+5%		
H: Anodic Champagne	+10%	6: DALI DT6 for TW	+172,00			40: 4000K	✓		
R: Special RAL/NCS Colours	ⓘ	8: DALI DT8 for TW	+172,00			65: 6500K	+5%		
						TW: Tunable White 2700-6500K*	+30%		
						[Q400-Q800]			

*Only in combination with DALI. Please add to dimming price.

*Only in combination with DT6,DT8 or Casambi control. Please add additional control price.

✓ standard / no extra charge ⓘ on request ✗ not available

Cubic Max A2/X2 | Surface

catalogue page 400

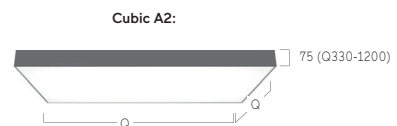
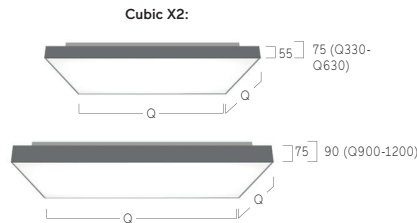

Cubic X2: Microprismatic | Direct-Indirect

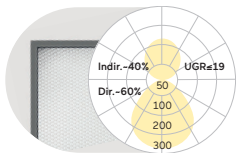

Q mm	Colour Temperature	Control	Power	Lumen/Watt	Weight kg	Code Snow White	Code Silver Anodised	CHF
330	4000K	On/Off	Medium	2470lm/18W	3,2	CX2AWE-840M-Q330	CX2AEE-840M-Q330	734,00
330	4000K	On/Off	High	3640lm/27W	3,2	CX2AWE-840H-Q330	CX2AEE-840H-Q330	734,00
430	4000K	On/Off	Medium	4360lm/30W	5,1	CX2AWE-840M-Q430	CX2AEE-840M-Q430	881,00
430	4000K	On/Off	High	6300lm/44W	5,1	CX2AWE-840H-Q430	CX2AEE-840H-Q430	881,00
530	4000K	On/Off	Medium	6000lm/42W	7,6	CX2AWE-840M-Q530	CX2AEE-840M-Q530	973,00
530	4000K	On/Off	High	11170lm/78W	7,6	CX2AWE-840H-Q530	CX2AEE-840H-Q530	973,00
630	4000K	On/Off	Medium	9610lm/68W	10,4	CX2AWE-840M-Q630	CX2AEE-840M-Q630	1096,00
630	4000K	On/Off	High	14270lm/103W	10,4	CX2AWE-840H-Q630	CX2AEE-840H-Q630	1096,00
900	4000K	On/Off	Medium	11660lm/89W	18,0	CX2AWE-840M-Q900	CX2AEE-840M-Q900	2246,00
900	4000K	On/Off	High	18570lm/161W	18,0	CX2AWE-840H-Q900	CX2AEE-840H-Q900	2246,00
1200	4000K	On/Off	Medium	19310lm/152W	32,0	CX2AWE-840M-Q1200	CX2AEE-840M-Q1200	3520,00
1200	4000K	On/Off	High	30990lm/273W	32,0	CX2AWE-840H-Q1200	CX2AEE-840H-Q1200	3520,00

Cubic X2: Opal Diffuser | Direct-Indirect

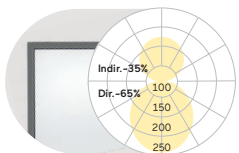

Q mm	Colour Temperature	Control	Power	Lumen/Watt	Weight kg	Code Snow White	Code Silver Anodised	CHF
330	4000K	On/Off	Medium	2510lm/18W	3,2	CX2OWE-840M-Q330	CX2OEE-840M-Q330	697,00
330	4000K	On/Off	High	3700lm/27W	3,2	CX2OWE-840H-Q330	CX2OEE-840H-Q330	697,00
430	4000K	On/Off	Medium	4430lm/30W	5,1	CX2OWE-840M-Q430	CX2OEE-840M-Q430	844,00
430	4000K	On/Off	High	6400lm/44W	5,1	CX2OWE-840H-Q430	CX2OEE-840H-Q430	844,00
530	4000K	On/Off	Medium	6110lm/42W	7,6	CX2OWE-840M-Q530	CX2OEE-840M-Q530	917,00
530	4000K	On/Off	High	11370lm/78W	7,6	CX2OWE-840H-Q530	CX2OEE-840H-Q530	917,00
630	4000K	On/Off	Medium	9770lm/68W	10,4	CX2OWE-840M-Q630	CX2OEE-840M-Q630	1022,00
630	4000K	On/Off	High	14530lm/103W	10,4	CX2OWE-840H-Q630	CX2OEE-840H-Q630	1022,00
900	4000K	On/Off	Medium	11900lm/89W	18,0	CX2OWE-840M-Q900	CX2OEE-840M-Q900	2190,00
900	4000K	On/Off	High	18970lm/161W	18,0	CX2OWE-840H-Q900	CX2OEE-840H-Q900	2190,00
1200	4000K	On/Off	Medium	19730lm/152W	32,0	CX2OWE-840M-Q1200	CX2OEE-840M-Q1200	3427,00
1200	4000K	On/Off	High	31700lm/273W	32,0	CX2OWE-840H-Q1200	CX2OEE-840H-Q1200	3427,00

... Cubic Max A2/X2 | Surface

Cubic A2: Microprismatic | Direct

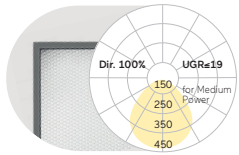

Q mm	Colour Temperature	Control	Power	Lumen/Watt	Weight kg	Code Snow White	Code Silver Anodised	CHF
330	4000K	On/Off	Medium	1360lm/12W	3,7	CA2AWE-840M-Q330	CA2AEE-840M-Q330	557,00
330	4000K	On/Off	High	2010lm/18W	3,7	CA2AWE-840H-Q330	CA2AEE-840H-Q330	557,00
430	4000K	On/Off	Medium	2370lm/19W	5,9	CA2AWE-840M-Q430	CA2AEE-840M-Q430	685,00
430	4000K	On/Off	High	3450lm/27W	5,9	CA2AWE-840H-Q430	CA2AEE-840H-Q430	685,00
530	4000K	On/Off	Medium	3630lm/27W	8,3	CA2AWE-840M-Q530	CA2AEE-840M-Q530	795,00
530	4000K	On/Off	High	6790lm/50W	8,3	CA2AWE-840H-Q530	CA2AEE-840H-Q530	795,00
630	4000K	On/Off	Medium	5200lm/40W	12,4	CA2AWE-840M-Q630	CA2AEE-840M-Q630	888,00
630	4000K	On/Off	High	8500lm/65W	12,4	CA2AWE-840H-Q630	CA2AEE-840H-Q630	888,00
900	4000K	On/Off	Medium	7910lm/67W	16,0	CA2AWE-840M-Q900	CA2AEE-840M-Q900	1973,00
900	4000K	On/Off	High	13240lm/129W	16,0	CA2AWE-840H-Q900	CA2AEE-840H-Q900	1973,00
1200	4000K	On/Off	Medium	14100lm/122W	26,7	CA2AWE-840M-Q1200	CA2AEE-840M-Q1200	3191,00
1200	4000K	On/Off	High	23550lm/228W	26,7	CA2AWE-840H-Q1200	CA2AEE-840H-Q1200	3191,00

Cubic A2: Opal Diffuser | Direct

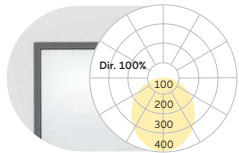

Q mm	Colour Temperature	Control	Power	Lumen/Watt	Weight kg	Code Snow White	Code Silver Anodised	CHF
330	4000K	On/Off	Medium	1400lm/12W	3,7	CA2OWE-840M-Q330	CA2OEE-840M-Q330	520,00
330	4000K	On/Off	High	2070lm/18W	3,7	CA2OWE-840H-Q330	CA2OEE-840H-Q330	520,00
430	4000K	On/Off	Medium	2440lm/19W	5,9	CA2OWE-840M-Q430	CA2OEE-840M-Q430	648,00
430	4000K	On/Off	High	3550lm/27W	5,9	CA2OWE-840H-Q430	CA2OEE-840H-Q430	648,00
530	4000K	On/Off	Medium	3740lm/27W	8,3	CA2OWE-840M-Q530	CA2OEE-840M-Q530	741,00
530	4000K	On/Off	High	6990lm/50W	8,3	CA2OWE-840H-Q530	CA2OEE-840H-Q530	741,00
630	4000K	On/Off	Medium	5360lm/40W	12,4	CA2OWE-840M-Q630	CA2OEE-840M-Q630	812,00
630	4000K	On/Off	High	8760lm/65W	12,4	CA2OWE-840H-Q630	CA2OEE-840H-Q630	812,00
900	4000K	On/Off	Medium	8150lm/67W	16,0	CA2OWE-840M-Q900	CA2OEE-840M-Q900	1917,00
900	4000K	On/Off	High	13640lm/129W	16,0	CA2OWE-840H-Q900	CA2OEE-840H-Q900	1917,00
1200	4000K	On/Off	Medium	14520lm/122W	26,7	CA2OWE-840M-Q1200	CA2OEE-840M-Q1200	3096,00
1200	4000K	On/Off	High	24260lm/228W	26,7	CA2OWE-840H-Q1200	CA2OEE-840H-Q1200	3096,00

Surcharges

Surface Finish	CHF	Control Gear	CHF	CHF	Colour Rendering	CHF	Colour Temperature	CHF	Additional Options	CHF
W: Snow White	✓	E: On/Off	✓	Q330-Q630	8: CRI>80	✓	22: 2200K	+5%	Emergency Module [DALI, Autotest, incl. 3H Battery]	+366,00
E: Silver Anodised	✓	L: DALI	+86,00	Q900-Q1200	9: CRI>90	+5%	27: 2700K	+5%	Radar Sensor	+209,00
U: Urban Graphite	✓	H: Touch-Dim	+86,00		F: Full Spectrum	+15%	30: 3000K	✓		
B: Jet Black	✓	C: Casambi*	+261,00				35: 3500K	+5%		
H: Anodic Champagne	+10%	6: DALI DT6 for TW	+172,00				40: 4000K	✓		
K: Satin Copper	+15%	8: DALI DT8 for TW	+172,00				65: 6500K	+5%		
R: Special RAL/NCS Colours	🔴		+343,00				TW: Tunable White 2700-6500K* [Q430-Q1200]	+30%		

*Only in combination with DALI. Please add to dimming price.

*Only in combination with DT6,DT8 or Casambi control. Please add additional control price.

✓ standard / no extra charge 🔴 on request ✗ not available

Cubic Ambient A7 | Surface

catalogue page 402

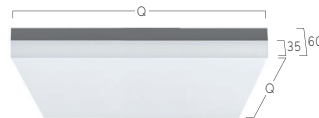
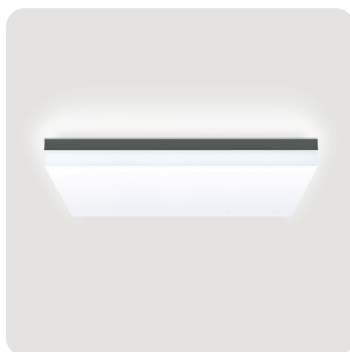

Ambient Diffuser | Direct

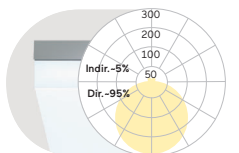

Q mm	Colour Temperature	Control	Power	Lumen/Watt	Weight kg	Code Snow White	Code Radiant Silver	CHF
300	4000K	On/Off	Medium	1480lm/12W	3,0	CA7FWE-840M-Q300	CA7FSE-840M-Q300	594,00
300	4000K	On/Off	High	2150lm/15W	3,0	CA7FWE-840H-Q300	CA7FSE-840H-Q300	594,00
400	4000K	On/Off	Medium	2950lm/21W	5,0	CA7FWE-840M-Q400	CA7FSE-840M-Q400	667,00
400	4000K	On/Off	High	3880lm/27W	5,0	CA7FWE-840H-Q400	CA7FSE-840H-Q400	667,00
500	4000K	On/Off	Medium	4410lm/30W	7,0	CA7FWE-840M-Q500	CA7FSE-840M-Q500	814,00
500	4000K	On/Off	High	6520lm/43W	7,0	CA7FWE-840H-Q500	CA7FSE-840H-Q500	814,00
600	4000K	On/Off	Medium	5650lm/38W	9,5	CA7FWE-840M-Q600	CA7FSE-840M-Q600	924,00
600	4000K	On/Off	High	8540lm/58W	9,5	CA7FWE-840H-Q600	CA7FSE-840H-Q600	924,00

Surcharges

Surface Finish	CHF	Control Gear	CHF	Colour Rendering	CHF	Colour Temperature	CHF	Additional Options	CHF
W: Snow White	✓	E: On/Off	✓	8: CRI>80	✓	22: 2200K	+5%	Emergency Module [DALI, Autotest, incl. 3H Battery] [Q400-Q800]	+366,00
S: Radiant Silver	✓	L: DALI	+86,00	9: CRI>90	+5%	27: 2700K	+5%		
U: Urban Graphite	✓	H: Touch-Dim	+86,00	F: Full Spectrum	+15%	30: 3000K	✓		
B: Jet Black	✓	C: Casambi*	+261,00			35: 3500K	+5%		
H: Anodic Champagne	+10%					40: 4000K	✓		
R: Special RAL/NCS Colours	🔴					65: 6500K	+5%		

*Only in combination with DALI. Please add to dimming price.

🟢 standard / no extra charge 🟡 on request 🔴 not available

Cubic Déco A3 | Surface

catalogue page **404**

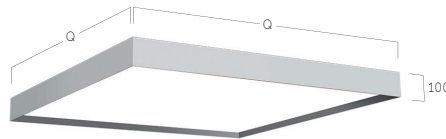

Microprismatic | Direct

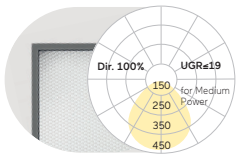

Q mm	Colour Temperature	Control	Power	Lumen/Watt	Weight kg	Code Snow White	Code Radiant Silver	CHF
330	4000K	On/Off	Medium	1360lm/12W	4,7	CA3AWE-840M-Q330-W	CA3ASE-840M-Q330-S	622,00
330	4000K	On/Off	High	2010lm/18W	4,7	CA3AWE-840H-Q330-W	CA3ASE-840H-Q330-S	622,00
430	4000K	On/Off	Medium	2370lm/19W	7,2	CA3AWE-840M-Q430-W	CA3ASE-840M-Q430-S	730,00
430	4000K	On/Off	High	3450lm/27W	7,2	CA3AWE-840H-Q430-W	CA3ASE-840H-Q430-S	730,00
530	4000K	On/Off	Medium	3630lm/27W	10,0	CA3AWE-840M-Q530-W	CA3ASE-840M-Q530-S	895,00
530	4000K	On/Off	High	6790lm/50W	10,0	CA3AWE-840H-Q530-W	CA3ASE-840H-Q530-S	895,00
630	4000K	On/Off	Medium	5200lm/40W	14,4	CA3AWE-840M-Q630-W	CA3ASE-840M-Q630-S	1040,00
630	4000K	On/Off	High	8500lm/65W	14,4	CA3AWE-840H-Q630-W	CA3ASE-840H-Q630-S	1040,00
900	4000K	On/Off	Medium	7910lm/67W	17,0	CA3AWE-840M-Q900-W	CA3ASE-840M-Q900-S	2198,00
900	4000K	On/Off	High	13240lm/129W	17,0	CA3AWE-840H-Q900-W	CA3ASE-840H-Q900-S	2198,00
1200	4000K	On/Off	Medium	14100lm/122W	22,1	CA3AWE-840M-Q1200-W	CA3ASE-840M-Q1200-S	3341,00
1200	4000K	On/Off	High	23550lm/228W	22,1	CA3AWE-840H-Q1200-W	CA3ASE-840H-Q1200-S	3341,00

Opal Diffuser | Direct

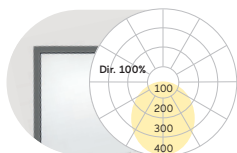

Q mm	Colour Temperature	Control	Power	Lumen/Watt	Weight kg	Code Snow White	Code Radiant Silver	CHF
330	4000K	On/Off	Medium	1400lm/12W	4,7	CA3OWE-840M-Q330-W	CA3OSE-840M-Q330-S	529,00
330	4000K	On/Off	High	2070lm/18W	4,7	CA3OWE-840H-Q330-W	CA3OSE-840H-Q330-S	529,00
430	4000K	On/Off	Medium	2440lm/19W	7,2	CA3OWE-840M-Q430-W	CA3OSE-840M-Q430-S	639,00
430	4000K	On/Off	High	3550lm/27W	7,2	CA3OWE-840H-Q430-W	CA3OSE-840H-Q430-S	639,00
530	4000K	On/Off	Medium	3740lm/27W	10,0	CA3OWE-840M-Q530-W	CA3OSE-840M-Q530-S	840,00
530	4000K	On/Off	High	6990lm/50W	10,0	CA3OWE-840H-Q530-W	CA3OSE-840H-Q530-S	840,00
630	4000K	On/Off	Medium	5360lm/40W	14,4	CA3OWE-840M-Q630-W	CA3OSE-840M-Q630-S	984,00
630	4000K	On/Off	High	8760lm/65W	14,4	CA3OWE-840H-Q630-W	CA3OSE-840H-Q630-S	984,00
900	4000K	On/Off	Medium	8150lm/67W	17,0	CA3OWE-840M-Q900-W	CA3OSE-840M-Q900-S	2106,00
900	4000K	On/Off	High	13640lm/129W	17,0	CA3OWE-840H-Q900-W	CA3OSE-840H-Q900-S	2106,00
1200	4000K	On/Off	Medium	14520lm/122W	22,1	CA3OWE-840M-Q1200-W	CA3OSE-840M-Q1200-S	3210,00
1200	4000K	On/Off	High	24260lm/228W	22,1	CA3OWE-840H-Q1200-W	CA3OSE-840H-Q1200-S	3210,00

Surcharges

Surface / Reflector Finish	CHF	Control Gear	CHF	CHF	Colour Temperature	CHF	Additional Options	CHF
Uni-Colours			Q300-Q600	Q900-Q1200				
W...W: Snow White / Snow White	✓	E: On/Off	✓	✓	22: 2200K	+5%	Radar Sensor	+209,00
V...V: Ivory White / Ivory White	✓	L: DALI	+86,00	+172,00	27: 2700K	+5%	Emergency Module [DALI, Autotest, incl. 3H Battery] [Q430-Q1200]	+366,00
S...S: Radiant Silver / Radiant Silver	✓	H: Touch-Dim	+86,00	+172,00	30: 3000K	✓		
U...U: Urban Graphite / Urban Graphite	✓	C: Casambi*	+261,00	+261,00	35: 3500K	+5%		
B...B: Jet Black / Jet Black	✓	6: DALI DT6 for TW	+172,00	+343,00	40: 4000K	✓		
H...H: Anodic Champ. / Anodic Champ.	+5%	8: DALI DT8 for TW	+172,00	+343,00	65: 6500K	+5%		
K...K: Satin Copper / Satin Copper	+15%				TW: Tunable White 2700-6500K* [Q430-Q1200]	+30%		

*Only in combination with DALI. Please add to dimming price.

🟢 standard / no extra charge 🟡 on request 🔴 not available

Surface / Reflector Finish

Dual Colours	CHF
W...G: Snow White / Satin Gold	+15%
W...K: Snow White / Satin Copper	+15%
W...B: Snow White / Jet Black	+15%
H...B: Anodic Champ. / Jet Black	+15%
B...G: Jet Black / Satin Gold	+15%
B...W: Jet Black / Snow White	+15%

Matric Déco A9 | Surface

catalogue page 406

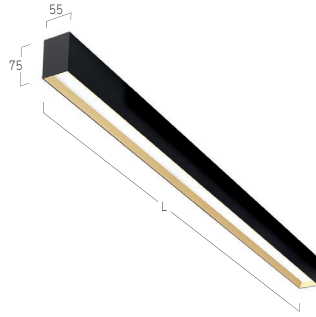
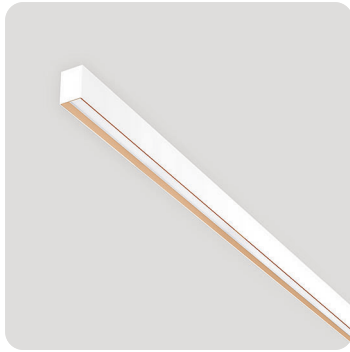

Lens Louve | Direct

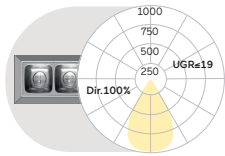

L mm	Colour Temperature	Control	Power	Lumen/Watt	Weight kg	Code Snow White/ Snow White	Code Jet Black/Jet Black	CHF
681	4000K	On/Off	Low	1090lm/10W	1,8	LA9LWE-840E-L681-W	LA9LBE-840E-L681-B	613,00
681	4000K	On/Off	High	2000lm/17W	1,8	LA9LWE-840H-L681-W	LA9LBE-840H-L681-B	613,00
945	4000K	On/Off	Low	1520lm/13W	2,5	LA9LWE-840E-L945-W	LA9LBE-840E-L945-B	637,00
945	4000K	On/Off	High	2790lm/24W	2,5	LA9LWE-840H-L945-W	LA9LBE-840H-L945-B	637,00
1209	4000K	On/Off	Low	1960lm/16W	3,1	LA9LWE-840E-L1209-W	LA9LBE-840E-L1209-B	742,00
1209	4000K	On/Off	High	3590lm/30W	3,1	LA9LWE-840H-L1209-W	LA9LBE-840H-L1209-B	742,00
1474	4000K	On/Off	Low	2390lm/19W	3,8	LA9LWE-840E-L1474-W	LA9LBE-840E-L1474-B	893,00
1474	4000K	On/Off	High	4390lm/37W	3,8	LA9LWE-840H-L1474-W	LA9LBE-840H-L1474-B	893,00
1738	4000K	On/Off	Low	2830lm/23W	4,5	LA9LWE-840E-L1738-W	LA9LBE-840E-L1738-B	1085,00
1738	4000K	On/Off	High	5190lm/43W	4,5	LA9LWE-840H-L1738-W	LA9LBE-840H-L1738-B	1085,00
2002	4000K	On/Off	Low	3260lm/26W	5,4	LA9LWE-840E-L2002-W	LA9LBE-840E-L2002-B	1322,00
2002	4000K	On/Off	High	5990lm/49W	5,4	LA9LWE-840H-L2002-W	LA9LBE-840H-L2002-B	1322,00
per meter	4000K	On/Off	Low	1650lm/12,5W	2,6	LA9LWE-840E-L****-W	LA9LBE-840E-L****-B	657,00
per meter	4000K	On/Off	High	3020lm/24,1W	2,6	LA9LWE-840H-L****-W	LA9LBE-840H-L****-B	657,00
per meter	4000K	DALI	Low	1650lm/12,5W	2,6	LA9LWL-840E-L****-W	LA9LBL-840E-L****-B	709,00
per meter	4000K	DALI	High	3020lm/24,1W	2,6	LA9LWL-840H-L****-W	LA9LBL-840H-L****-B	709,00

Microprismatic | Direct

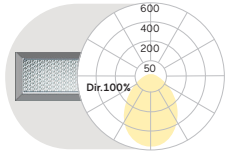

L mm	Colour Temperature	Control	Power	Lumen/Watt	Weight kg	Code Snow White/ Snow White	Code Jet Black/Jet Black	CHF
600	4000K	On/Off	Low	550lm/7W	1,8	LA9AWE-840E-L600-W	LA9ABE-840E-L600-B	473,00
600	4000K	On/Off	High	990lm/12W	1,8	LA9AWE-840H-L600-W	LA9ABE-840H-L600-B	473,00
890	4000K	On/Off	Low	830lm/10W	2,5	LA9AWE-840E-L890-W	LA9ABE-840E-L890-B	497,00
890	4000K	On/Off	High	1490lm/16W	2,5	LA9AWE-840H-L890-W	LA9ABE-840H-L890-B	497,00
1182	4000K	On/Off	Low	1110lm/12W	3,1	LA9AWE-840E-L1182-W	LA9ABE-840E-L1182-B	550,00
1182	4000K	On/Off	High	1990lm/21W	3,1	LA9AWE-840H-L1182-W	LA9ABE-840H-L1182-B	550,00
1475	4000K	On/Off	Low	1390lm/14W	3,8	LA9AWE-840E-L1475-W	LA9ABE-840E-L1475-B	648,00
1475	4000K	On/Off	High	2480lm/25W	3,8	LA9AWE-840H-L1475-W	LA9ABE-840H-L1475-B	648,00
1765	4000K	On/Off	Low	1660lm/17W	4,5	LA9AWE-840E-L1765-W	LA9ABE-840E-L1765-B	805,00
1765	4000K	On/Off	High	2980lm/30W	4,5	LA9AWE-840H-L1765-W	LA9ABE-840H-L1765-B	805,00
2055	4000K	On/Off	Low	1940lm/22W	5,4	LA9AWE-840E-L2055-W	LA9ABE-840E-L2055-B	1005,00
2055	4000K	On/Off	High	3480lm/37W	5,4	LA9AWE-840H-L2055-W	LA9ABE-840H-L2055-B	1005,00
per meter	4000K	On/Off	Low	940lm/9,5W	2,7	LA9AWE-840E-L****-W	LA9ABE-840E-L****-B	490,00
per meter	4000K	On/Off	High	1690lm/16,9W	2,7	LA9AWE-840H-L****-W	LA9ABE-840H-L****-B	490,00
per meter	4000K	DALI	Low	940lm/9,5W	2,7	LA9AWL-840E-L****-W	LA9ABL-840E-L****-B	543,00
per meter	4000K	DALI	High	1690lm/16,9W	2,7	LA9AWL-840H-L****-W	LA9ABL-840H-L****-B	543,00

Opal Diffuser | Direct

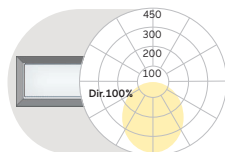

L mm	Colour Temperature	Control	Power	Lumen/Watt	Weight kg	Code Snow White/ Snow White	Code Jet Black/Jet Black	CHF
600	4000K	On/Off	Medium	780lm/9W	1,8	LA9OWE-840M-L600-W	LA9OBE-840M-L600-B	455,00
600	4000K	On/Off	High	1060lm/12W	1,8	LA9OWE-840H-L600-W	LA9OBE-840H-L600-B	455,00
890	4000K	On/Off	Medium	1170lm/12W	2,5	LA9OWE-840M-L890-W	LA9OBE-840M-L890-B	480,00
890	4000K	On/Off	High	1590lm/16W	2,5	LA9OWE-840H-L890-W	LA9OBE-840H-L890-B	480,00
1182	4000K	On/Off	Medium	1560lm/15W	3,1	LA9OWE-840M-L1182-W	LA9OBE-840M-L1182-B	525,00
1182	4000K	On/Off	High	2110lm/21W	3,1	LA9OWE-840H-L1182-W	LA9OBE-840H-L1182-B	525,00
1475	4000K	On/Off	Medium	1950lm/19W	3,8	LA9OWE-840M-L1475-W	LA9OBE-840M-L1475-B	613,00
1475	4000K	On/Off	High	2640lm/25W	3,8	LA9OWE-840H-L1475-W	LA9OBE-840H-L1475-B	613,00
1765	4000K	On/Off	Medium	2330lm/22W	4,5	LA9OWE-840M-L1765-W	LA9OBE-840M-L1765-B	760,00
1765	4000K	On/Off	High	3170lm/30W	4,5	LA9OWE-840H-L1765-W	LA9OBE-840H-L1765-B	760,00
2055	4000K	On/Off	Medium	2720lm/28W	5,4	LA9OWE-840M-L2055-W	LA9OBE-840M-L2055-B	935,00
2055	4000K	On/Off	High	3700lm/37W	5,4	LA9OWE-840H-L2055-W	LA9OBE-840H-L2055-B	935,00
per meter	4000K	On/Off	Medium	1320lm/12,4W	2,7	LA9OWE-840M-L****-W	LA9OBE-840M-L****-B	455,00
per meter	4000K	On/Off	High	1800lm/16,9W	2,7	LA9OWE-840H-L****-W	LA9OBE-840H-L****-B	455,00
per meter	4000K	DALI	Medium	1320lm/12,4W	2,7	LA9OWL-840M-L****-W	LA9OBL-840M-L****-B	508,00
per meter	4000K	DALI	High	1800lm/16,9W	2,7	LA9OWL-840H-L****-W	LA9OBL-840H-L****-B	508,00

**** Your length in mm

Meterpreise für Lichtsysteme nach Maß ab Mindestlänge 2200mm | Prices per metre for customised lighting systems with a minimum length of 2200mm
 Prix au mètre pour systèmes d'éclairage sur mesure à partir d'une longueur minimale de 2200mm

Surcharges

Surface / Reflector Finish + Lens Louvre*	CHF
Uni-Colours	
W...W: Snow White / Snow White	✓
V...V: Ivory White / Ivory White	✓
A...A: Satin Silver / Satin Silver	✓
U...U: Urban Graphite / Urban Graphite	✓
B...B: Jet Black / Jet Black	✓
H...H: Anodic Champ. / Anodic Champ.	+10%
K...K: Satin Copper / Satin Copper	+15%

Surface / Reflector Finish + Lens Louvre*	CHF
Dual Colours	
W...G: Snow White / Satin Gold	+15%
W...K: Snow White / Satin Copper	+15%
W...B: Snow White / Jet Black	+15%
H...B: Anodic Champagne / Jet Black	+15%
B...G: Jet Black / Satin Gold	+15%
B...W: Jet Black / Snow White	+15%

Colour Rendering	CHF
8: CRI>80	✓
9: CRI>90	+5%
F: Full Spectrum	+15%

Control Gear	CHF	CHF
L600-L1765	✓	✓
L: DALI	+86,00	+98,00
H: Touch-Dim	+86,00	+98,00
C: Casambi* [L890-L2055]	+261,00	+261,00
6: DALI DT6 for TW [L1182-L2055]	+172,00	+196,00
8: DALI DT8 for TW [L890-L2055]	+172,00	+196,00

*Only in combination with DALI.
Please add to dimming price.

Colour Temperature	CHF
22: 2200K	+5%
27: 2700K	+5%
30: 3000K	✓
35: 3500K	+5%
40: 4000K	✓
65: 6500K	+5%
TW: Tunable White 2700-6500K*	+30%

*Only in combination with DT6, DT8 or Casambi control. Please add additional control price.

Additional Options	CHF
Emergency Module [DALI, Autotest, incl. 3H Battery] [L1182-L2055]	+366,00

✓ standard / no extra charge ⚠ on request ✗ not available

Matric AY | System 40mm Surface

catalogue page **408**

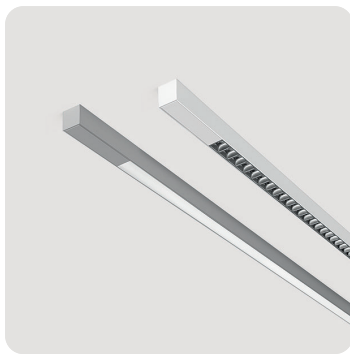

Lens Louvre | Direct

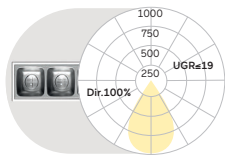

L mm	Colour Temperature	Control	Power	Lumen/Watt	Weight kg	Code Snow White/Jet Black	Code Jet Black/Jet Black	CHF
1592	4000K	On/Off	Medium	1590lm/13W	2,2	LAYLWE-840M-L1592-B*	LAYLBE-840M-L1592-B*	786,00
1592	4000K	On/Off	High	2190lm/18W	2,2	LAYLWE-840H-L1592-B*	LAYLBE-840H-L1592-B*	786,00
1857	4000K	On/Off	Medium	1990lm/16W	3,0	LAYLWE-840M-L1857-B*	LAYLBE-840M-L1857-B*	954,00
1857	4000K	On/Off	High	2730lm/22W	3,0	LAYLWE-840H-L1857-B*	LAYLBE-840H-L1857-B*	954,00

Microprismatic | Direct

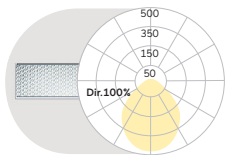

L mm	Colour Temperature	Control	Power	Lumen/Watt	Weight kg	Code Snow White	Code Jet Black	CHF
1592	4000K	On/Off	Medium	1840lm/18W	2,3	LAYAWE-840M-L1592	LAYABE-840M-L1592	587,00
1592	4000K	On/Off	High	2540lm/24W	2,3	LAYAWE-840H-L1592	LAYABE-840H-L1592	587,00
1894	4000K	On/Off	Medium	2340lm/22W	2,8	LAYAWE-840M-L1894	LAYABE-840M-L1894	716,00
1894	4000K	On/Off	High	3230lm/30W	2,8	LAYAWE-840H-L1894	LAYABE-840H-L1894	716,00

Opal Diffuser | Direct

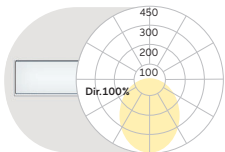

L mm	Colour Temperature	Control	Power	Lumen/Watt	Weight kg	Code Snow White	Code Jet Black	CHF
1592	4000K	On/Off	Medium	1970lm/18W	2,3	LAYOWE-840M-L1592	LAYOBE-840M-L1592	552,00
1592	4000K	On/Off	High	2710lm/24W	2,3	LAYOWE-840H-L1592	LAYOBE-840H-L1592	552,00
1894	4000K	On/Off	Medium	2500lm/22W	2,8	LAYOWE-840M-L1894	LAYOBE-840M-L1894	664,00
1894	4000K	On/Off	High	3450lm/30W	2,8	LAYOWE-840H-L1894	LAYOBE-840H-L1894	664,00

Surcharges

Surface Finish	CHF	Control Gear	CHF	Colour Rendering	CHF	Colour Temperature	CHF	Lens Louvre*	CHF
W: Snow White	✓	E: On/Off	✓	8: CRI>80	✓	22: 2200K	+5%	W: Snow White	✓
V: Ivory White	✓	L: DALI	+86,00	9: CRI>90	+5%	27: 2700K	+5%	A: Satin Silver	✓
A: Satin Silver	✓	H: Touch-Dim	+86,00	F: Full Spectrum	+15%	30: 3000K	✓	B: Jet Black	✓
S: Radiant Silver	✓	C: Casambi* [L890-L2055]	+261,00			35: 3500K	+5%	H: Anodic Champagne	✓
U: Urban Graphite	✓					40: 4000K	✓	K: Satin Copper	✓
B: Jet Black	✓					65: 6500K	+5%	G: Satin Gold	✓
H: Anodic Champagne	+10%	*Only in combination with DALI. Please add to dimming price.							
K: Satin Copper	+15%								
R: Special RAL/NCS Colours	⚠								

✓ standard / no extra charge ⚠ on request ✗ not available

Matric XY | System 40mm Surface

catalogue page 410

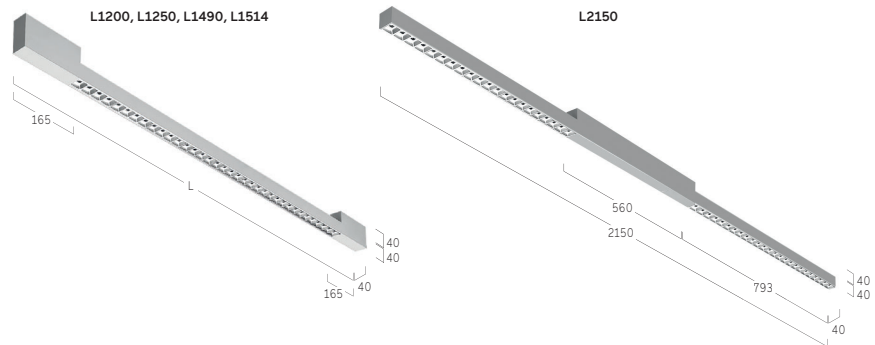
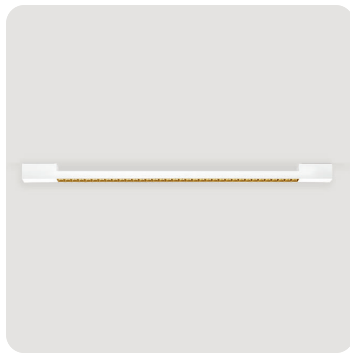

Lens Louvre | Direct-Indirect

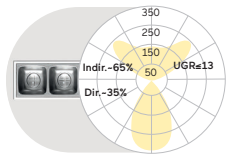

L mm	Colour Temperature	Control	Power	Lumen/Watt	Weight kg	Code Snow White/Jet Black	Code Jet Black/Jet Black	CHF
1250	4000K	On/Off	Medium	4140lm/33W	3,2	LXYLWE-840M-L1250-B*	LXYLBE-840M-L1250-B*	909,00
1250	4000K	On/Off	High	4660lm/37W	3,2	LXYLWE-840H-L1250-B*	LXYLBE-840H-L1250-B*	909,00
1514	4000K	On/Off	Medium	5460lm/41W	3,6	LXYLWE-840M-L1514-B*	LXYLBE-840M-L1514-B*	1084,00
1514	4000K	On/Off	High	6130lm/47W	3,6	LXYLWE-840H-L1514-B*	LXYLBE-840H-L1514-B*	1084,00
2150	4000K	On/Off	Medium	7270lm/55W	5,1	LXYLWE-840M-L2150-B*	LXYLBE-840M-L2150-B*	1532,00
2150	4000K	On/Off	High	8170lm/63W	5,1	LXYLWE-840H-L2150-B*	LXYLBE-840H-L2150-B*	1532,00

Microprismatic | Direct-Indirect

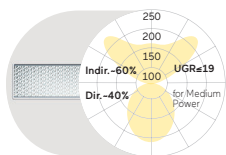

L mm	Colour Temperature	Control	Power	Lumen/Watt	Weight kg	Code Snow White	Code Jet Black	CHF
1200	4000K	On/Off	Medium	4250lm/35W	2,8	LXYAWE-840M-L1200	LXYABE-840M-L1200	779,00
1200	4000K	On/Off	High	4830lm/41W	2,8	LXYAWE-840H-L1200	LXYABE-840H-L1200	779,00
1490	4000K	On/Off	Medium	5680lm/46W	3,2	LXYAWE-840M-L1490	LXYABE-840M-L1490	891,00
1490	4000K	On/Off	High	6440lm/53W	3,2	LXYAWE-840H-L1490	LXYABE-840H-L1490	891,00
2150	4000K	On/Off	Medium	7570lm/63W	4,5	LXYAWE-840M-L2150	LXYABE-840M-L2150	1294,00
2150	4000K	On/Off	High	8580lm/74W	4,5	LXYAWE-840H-L2150	LXYABE-840H-L2150	1294,00

Opal Diffuser | Direct-Indirect

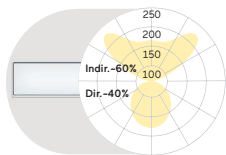

L mm	Colour Temperature	Control	Power	Lumen/Watt	Weight kg	Code Snow White	Code Jet Black	CHF
1200	4000K	On/Off	Medium	4360lm/35W	2,8	LXYOWE-840M-L1200	LXYOBE-840M-L1200	751,00
1200	4000K	On/Off	High	4970lm/41W	2,8	LXYOWE-840H-L1200	LXYOBE-840H-L1200	751,00
1490	4000K	On/Off	Medium	5820lm/46W	3,2	LXYOWE-840M-L1490	LXYOBE-840M-L1490	856,00
1490	4000K	On/Off	High	6630lm/53W	3,2	LXYOWE-840H-L1490	LXYOBE-840H-L1490	856,00
2150	4000K	On/Off	Medium	7750lm/63W	4,5	LXYOWE-840M-L2150	LXYOBE-840M-L2150	1224,00
2150	4000K	On/Off	High	8840lm/74W	4,5	LXYOWE-840H-L2150	LXYOBE-840H-L2150	1224,00

Surcharges

Surface Finish	CHF	Control Gear	CHF	Colour Rendering	CHF	Colour Temperature	CHF	Lens Louvre*	CHF
W: Snow White	✓	E: On/Off	✓	8: CRI>80	✓	22: 2200K	+5%	W: Snow White	✓
V: Ivory White	✓	L: DALI	+86,00	9: CRI>90	+5%	27: 2700K	+5%	A: Satin Silver	✓
A: Satin Silver	✓	H: Touch-Dim	+86,00	F: Full Spectrum	+15%	30: 3000K	✓	B: Jet Black	✓
S: Radiant Silver	✓					35: 3500K	+5%	H: Anodic Champagne	✓
U: Urban Graphite	✓					40: 4000K	✓	K: Satin Copper	✓
B: Jet Black	✓					65: 6500K	+5%	G: Satin Gold	✓
H: Anodic Champagne	+10%								
K: Satin Copper	+15%								
R: Special RAL/NCS Colours	🔧								

✓ standard / no extra charge 🔧 on request ✗ not available

Matric AX | System 40mm Surface

catalogue page 418

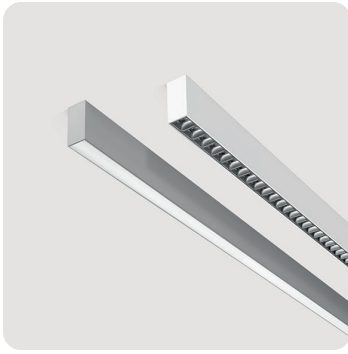

Lens Louvre | Microprismatic | Opal Diffuser | Wallwasher

Ambient



Lens Louvre | Direct

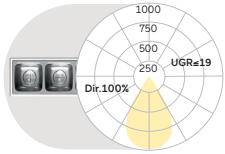

L mm	Colour Temperature	Control	Power	Lumen/Watt	Weight kg	Code Snow White/Jet Black	Code Silver Anodised/Jet Black	CHF
665	4000K	On/Off	Low	1090lm/10W	1,5	LAXLWE-840E-L665-B*	LAXLEE-840E-L665-B*	531,00
665	4000K	On/Off	High	2000lm/17W	1,5	LAXLWE-840H-L665-B*	LAXLEE-840H-L665-B*	531,00
930	4000K	On/Off	Low	1520lm/13W	1,9	LAXLWE-840E-L930-B*	LAXLEE-840E-L930-B*	550,00
930	4000K	On/Off	High	2790lm/24W	1,9	LAXLWE-840H-L930-B*	LAXLEE-840H-L930-B*	550,00
1194	4000K	On/Off	Low	1960lm/16W	2,4	LAXLWE-840E-L1194-B*	LAXLEE-840E-L1194-B*	620,00
1194	4000K	On/Off	High	3590lm/30W	2,4	LAXLWE-840H-L1194-B*	LAXLEE-840H-L1194-B*	620,00
1458	4000K	On/Off	Low	2390lm/19W	2,8	LAXLWE-840E-L1458-B*	LAXLEE-840E-L1458-B*	742,00
1458	4000K	On/Off	High	4390lm/37W	2,8	LAXLWE-840H-L1458-B*	LAXLEE-840H-L1458-B*	742,00
1723	4000K	On/Off	Low	2830lm/23W	3,3	LAXLWE-840E-L1723-B*	LAXLEE-840E-L1723-B*	910,00
1723	4000K	On/Off	High	5190lm/43W	3,3	LAXLWE-840H-L1723-B*	LAXLEE-840H-L1723-B*	910,00
1987	4000K	On/Off	Low	3260lm/26W	3,7	LAXLWE-840E-L1987-B*	LAXLEE-840E-L1987-B*	1120,00
1987	4000K	On/Off	High	5990lm/49W	3,7	LAXLWE-840H-L1987-B*	LAXLEE-840H-L1987-B*	1120,00
per meter	4000K	On/Off	Low	1650lm/12,5W	2,0	LAXLWE-840E-L****-B*	LAXLEE-840E-L****-B*	552,00
per meter	4000K	On/Off	High	3020lm/24,1W	2,0	LAXLWE-840H-L****-B*	LAXLEE-840H-L****-B*	552,00
per meter	4000K	DALI	Low	1650lm/12,5W	2,0	LAXLWL-840E-L****-B*	LAXLEL-840E-L****-B*	604,00
per meter	4000K	DALI	High	3020lm/24,1W	2,0	LAXLWL-840H-L****-B*	LAXLEL-840H-L****-B*	604,00

Microprismatic | Direct

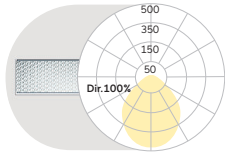

L mm	Colour Temperature	Control	Power	Lumen/Watt	Weight kg	Code Snow White	Code Silver Anodised	CHF
600	4000K	On/Off	Low	610lm/7W	1,4	LAXAWE-840E-L600	LAXAEE-840E-L600	427,00
600	4000K	On/Off	High	1100lm/12W	1,4	LAXAWE-840H-L600	LAXAEE-840H-L600	427,00
890	4000K	On/Off	Low	920lm/10W	1,9	LAXAWE-840E-L890	LAXAEE-840E-L890	445,00
890	4000K	On/Off	High	1650lm/16W	1,9	LAXAWE-840H-L890	LAXAEE-840H-L890	445,00
1182	4000K	On/Off	Low	1230lm/12W	2,4	LAXAWE-840E-L1182	LAXAEE-840E-L1182	473,00
1182	4000K	On/Off	High	2200lm/21W	2,4	LAXAWE-840H-L1182	LAXAEE-840H-L1182	473,00
1475	4000K	On/Off	Low	1530lm/14W	2,9	LAXAWE-840E-L1475	LAXAEE-840E-L1475	543,00
1475	4000K	On/Off	High	2750lm/25W	2,9	LAXAWE-840H-L1475	LAXAEE-840H-L1475	543,00
1765	4000K	On/Off	Low	1840lm/17W	3,4	LAXAWE-840E-L1765	LAXAEE-840E-L1765	672,00
1765	4000K	On/Off	High	3300lm/30W	3,4	LAXAWE-840H-L1765	LAXAEE-840H-L1765	672,00
2055	4000K	On/Off	Low	2150lm/22W	4,2	LAXAWE-840E-L2055	LAXAEE-840E-L2055	823,00
2055	4000K	On/Off	High	3850lm/37W	4,2	LAXAWE-840H-L2055	LAXAEE-840H-L2055	823,00
per meter	4000K	On/Off	Low	1040lm/9,5W	2,0	LAXAWE-840E-L****	LAXAEE-840E-L****	403,00
per meter	4000K	On/Off	High	1870lm/16,9W	2,0	LAXAWE-840H-L****	LAXAEE-840H-L****	403,00
per meter	4000K	DALI	Low	1040lm/9,5W	2,0	LAXAWL-840E-L****	LAXAEL-840E-L****	455,00
per meter	4000K	DALI	High	1870lm/16,9W	2,0	LAXAWL-840H-L****	LAXAEL-840H-L****	455,00

Opal Diffuser | Direct

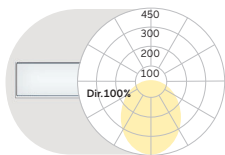

L mm	Colour Temperature	Control	Power	Lumen/Watt	Weight kg	Code Snow White	Code Silver Anodised	CHF
600	4000K	On/Off	Medium	870lm/9W	1,4	LAXOWE-840M-L600	LAXOEE-840M-L600	410,00
600	4000K	On/Off	High	1180lm/12W	1,4	LAXOWE-840H-L600	LAXOEE-840H-L600	410,00
890	4000K	On/Off	Medium	1300lm/12W	1,9	LAXOWE-840M-L890	LAXOEE-840M-L890	427,00
890	4000K	On/Off	High	1760lm/16W	1,9	LAXOWE-840H-L890	LAXOEE-840H-L890	427,00
1182	4000K	On/Off	Medium	1730lm/15W	2,4	LAXOWE-840M-L1182	LAXOEE-840M-L1182	445,00
1182	4000K	On/Off	High	2350lm/21W	2,4	LAXOWE-840H-L1182	LAXOEE-840H-L1182	445,00
1475	4000K	On/Off	Medium	2160lm/19W	2,9	LAXOWE-840M-L1475	LAXOEE-840M-L1475	508,00
1475	4000K	On/Off	High	2940lm/25W	2,9	LAXOWE-840H-L1475	LAXOEE-840H-L1475	508,00
1765	4000K	On/Off	Medium	2600lm/22W	3,4	LAXOWE-840M-L1765	LAXOEE-840M-L1765	620,00
1765	4000K	On/Off	High	3530lm/30W	3,4	LAXOWE-840H-L1765	LAXOEE-840H-L1765	620,00
2055	4000K	On/Off	Medium	3030lm/28W	4,2	LAXOWE-840M-L2055	LAXOEE-840M-L2055	760,00
2055	4000K	On/Off	High	4110lm/37W	4,2	LAXOWE-840H-L2055	LAXOEE-840H-L2055	760,00
per meter	4000K	On/Off	Medium	1470lm/12,4W	2,0	LAXOWE-840M-L****	LAXOEE-840M-L****	377,00
per meter	4000K	On/Off	High	2000lm/16,9W	2,0	LAXOWE-840H-L****	LAXOEE-840H-L****	377,00
per meter	4000K	DALI	Medium	1470lm/12,4W	2,0	LAXOWL-840M-L****	LAXOEL-840M-L****	429,00
per meter	4000K	DALI	High	2000lm/16,9W	2,0	LAXOWL-840H-L****	LAXOEL-840H-L****	429,00

**** Your length in mm

Meterpreise für Lichtsysteme nach Maß ab Mindestlänge 2200mm | Prices per metre for customised lighting systems with a minimum length of 2200mm
 Prix au mètre pour systèmes d'éclairage sur mesure à partir d'une longueur minimale de 2200mm

... Matric AX | System 40mm Surface

Wallwasher | Direct

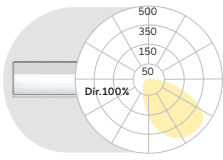

L mm	Colour Temperature	Control	Power	Lumen/Watt	Weight kg	Code Snow White	Code Silver Anodised	CHF
600	4000K	On/Off	Medium	840lm/11W	1,4	LAXGWE-840M-L600	LAXGEE-840M-L600	462,00
600	4000K	On/Off	High	1070lm/14W	1,4	LAXGWE-840H-L600	LAXGEE-840H-L600	462,00
890	4000K	On/Off	Medium	1260lm/15W	1,9	LAXGWE-840M-L890	LAXGEE-840M-L890	482,00
890	4000K	On/Off	High	1610lm/19W	1,9	LAXGWE-840H-L890	LAXGEE-840H-L890	482,00
1182	4000K	On/Off	Medium	1680lm/19W	2,4	LAXGWE-840M-L1182	LAXGEE-840M-L1182	529,00
1182	4000K	On/Off	High	2150lm/25W	2,4	LAXGWE-840H-L1182	LAXGEE-840H-L1182	529,00
1475	4000K	On/Off	Medium	2100lm/23W	3,0	LAXGWE-840M-L1475	LAXGEE-840M-L1475	592,00
1475	4000K	On/Off	High	2680lm/30W	3,0	LAXGWE-840H-L1475	LAXGEE-840H-L1475	592,00
1765	4000K	On/Off	Medium	2520lm/28W	3,5	LAXGWE-840M-L1765	LAXGEE-840M-L1765	695,00
1765	4000K	On/Off	High	3220lm/36W	3,5	LAXGWE-840H-L1765	LAXGEE-840H-L1765	695,00
2055	4000K	On/Off	Medium	2940lm/34W	4,2	LAXGWE-840M-L2055	LAXGEE-840M-L2055	884,00
2055	4000K	On/Off	High	3760lm/44W	4,2	LAXGWE-840H-L2055	LAXGEE-840H-L2055	884,00
per meter	4000K	On/Off	Medium	1430lm/15,6W	2,1	LAXGWE-840M-L****	LAXGEE-840M-L****	420,00
per meter	4000K	On/Off	High	1830lm/20,3W	2,1	LAXGWE-840H-L****	LAXGEE-840H-L****	420,00
per meter	4000K	DALI	Medium	1430lm/15,6W	2,1	LAXGWL-840M-L****	LAXGEL-840M-L****	473,00
per meter	4000K	DALI	High	1830lm/20,3W	2,1	LAXGWL-840H-L****	LAXGEL-840H-L****	473,00

Ambient | Direct

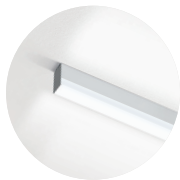
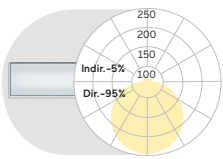

L mm	Colour Temperature	Control	Power	Lumen/Watt	Weight kg	Code Snow White	Code Silver Anodised	CHF
600	4000K	On/Off	Medium	1080lm/9W	1,4	LAXFWE-840M-L600	LAXFEE-840M-L600	459,00
600	4000K	On/Off	High	1460lm/12W	1,4	LAXFWE-840H-L600	LAXFEE-840H-L600	459,00
890	4000K	On/Off	Medium	1620lm/12W	1,9	LAXFWE-840M-L890	LAXFEE-840M-L890	482,00
890	4000K	On/Off	High	2190lm/16W	1,9	LAXFWE-840H-L890	LAXFEE-840H-L890	482,00
1182	4000K	On/Off	Medium	2150lm/16W	2,4	LAXFWE-840M-L1182	LAXFEE-840M-L1182	518,00
1182	4000K	On/Off	High	2910lm/21W	2,4	LAXFWE-840H-L1182	LAXFEE-840H-L1182	518,00
1475	4000K	On/Off	Medium	2690lm/19W	3,0	LAXFWE-840M-L1475	LAXFEE-840M-L1475	594,00
1475	4000K	On/Off	High	3640lm/26W	3,0	LAXFWE-840H-L1475	LAXFEE-840H-L1475	594,00
1765	4000K	On/Off	Medium	3230lm/22W	3,5	LAXFWE-840M-L1765	LAXFEE-840M-L1765	711,00
1765	4000K	On/Off	High	4370lm/30W	3,5	LAXFWE-840H-L1765	LAXFEE-840H-L1765	711,00
2055	4000K	On/Off	Medium	3770lm/28W	4,2	LAXFWE-840M-L2055	LAXFEE-840M-L2055	903,00
2055	4000K	On/Off	High	5100lm/37W	4,2	LAXFWE-840H-L2055	LAXFEE-840H-L2055	903,00
per meter	4000K	On/Off	Medium	1830lm/12,6W	2,1	LAXFWE-840M-L****	LAXFEE-840M-L****	604,00
per meter	4000K	On/Off	High	2480lm/17,2W	2,1	LAXFWE-840H-L****	LAXFEE-840H-L****	604,00
per meter	4000K	DALI	Medium	1830lm/12,6W	2,1	LAXFWL-840M-L****	LAXFEL-840M-L****	657,00
per meter	4000K	DALI	High	2480lm/17,2W	2,1	LAXFWL-840H-L****	LAXFEL-840H-L****	657,00

**** Your length in mm

Meterpreise für Lichtsysteme nach Maß ab Mindestlänge 2200mm | Prices per metre for customised lighting systems with a minimum length of 2200mm
 Prix au mètre pour systèmes d'éclairage sur mesure à partir d'une longueur minimale de 2200mm



90° Corner
Opal/Micropismatic

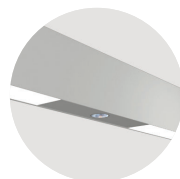

Midpin-Downlight XD
310lm/5W/Ø21mm



Midpin Spotlight XM
770lm/10W/Ø40mm



Midpin Spotlight XP
770lm/10W/Ø40mm

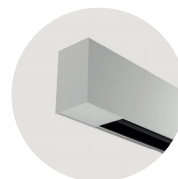

3-Phase Track



Multisensor

Surcharges

Surface Finish	CHF	Control Gear	CHF L600-L1765	CHF L2055	Colour Temperature	CHF	Lens Louvre*	CHF	Colour Rendering	CHF
W: Snow White	✓	E: On/Off	✓	✓	22: 2200K	+5%	W: Snow White	✓	8: CRI>80	✓
V: Ivory White	✓	L: DALI	+86,00	+172,00	27: 2700K	+5%	A: Satin Silver	✓	9: CRI>90	+5%
A: Satin Silver	+15%	H: Touch-Dim	+86,00	+172,00	30: 3000K	✓	B: Jet Black	✓	F: Full Spectrum	+15%
E: Silver Anodised	✓	C: Casambi* [L890-L2055]	+261,00	+261,00	35: 3500K	+5%	H: Anodic Champagne	✓	Additional Options	CHF
U: Urban Graphite	✓	6: DALI DT6 for TW [L1182-L2055]	+172,00	+343,00	40: 4000K	✓	K: Satin Copper	✓	90° Corner	ⓘ
B: Jet Black	✓	8: DALI DT8 for TW [L890-L2055]	+172,00	+343,00	65: 6500K	+5%	G: Satin Gold	✓	Midpin Downlight XD	+363,00
H: Anodic Champagne	+10%				TW: Tunable White 2700-6500K*	+30%			Midpin Spotlight XM	+363,00
K: Satin Copper	+15%								Midpin Spotlight XP	+433,00
R: Special RAL/NCS Colours	ⓘ								Multisensor [L1182-L2055]	+261,00
		*Only in combination with DALI. Please add to dimming price.							Emergency Module [DALI, Autotest, incl. 3H Battery] [L1182-L2055]	+366,00

✓ standard / no extra charge ⓘ on request ✗ not available

Matric A3 | System 55mm Surface

catalogue page 420

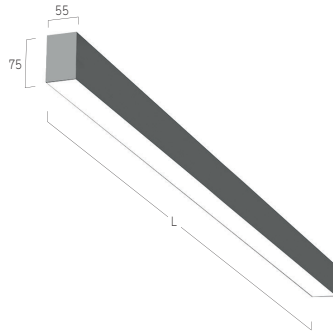
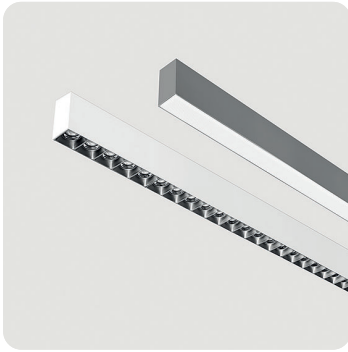

Lens Louvre | Direct

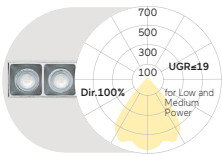

L mm	Colour Temperature	Control	Power	Lumen/Watt	Weight kg	Code Snow White/Jet Black	Code Silver Anodised/Jet Black	CHF
752	4000K	On/Off	Low	1370lm/11W	2,3	LA3LWE-840E-L752-B*	LA3LEE-840E-L752-B*	587,00
752	4000K	On/Off	Medium	1870lm/15W	2,3	LA3LWE-840M-L752-B*	LA3LEE-840M-L752-B*	587,00
752	4000K	On/Off	High	2690lm/22W	2,3	LA3LWE-840H-L752-B*	LA3LEE-840H-L752-B*	587,00
1002	4000K	On/Off	Low	1830lm/14W	2,9	LA3LWE-840E-L1002-B*	LA3LEE-840E-L1002-B*	602,00
1002	4000K	On/Off	Medium	2500lm/19W	2,9	LA3LWE-840M-L1002-B*	LA3LEE-840M-L1002-B*	602,00
1002	4000K	On/Off	High	3590lm/28W	2,9	LA3LWE-840H-L1002-B*	LA3LEE-840H-L1002-B*	602,00
1252	4000K	On/Off	Low	2290lm/16W	3,4	LA3LWE-840E-L1252-B*	LA3LEE-840E-L1252-B*	690,00
1252	4000K	On/Off	Medium	3120lm/23W	3,4	LA3LWE-840M-L1252-B*	LA3LEE-840M-L1252-B*	690,00
1252	4000K	On/Off	High	4500lm/34W	3,4	LA3LWE-840H-L1252-B*	LA3LEE-840H-L1252-B*	690,00
1502	4000K	On/Off	Low	2750lm/19W	4,0	LA3LWE-840E-L1502-B*	LA3LEE-840E-L1502-B*	823,00
1502	4000K	On/Off	Medium	3750lm/27W	4,0	LA3LWE-840M-L1502-B*	LA3LEE-840M-L1502-B*	823,00
1502	4000K	On/Off	High	5380lm/40W	4,0	LA3LWE-840H-L1502-B*	LA3LEE-840H-L1502-B*	823,00
1752	4000K	On/Off	Low	3200lm/22W	4,6	LA3LWE-840E-L1752-B*	LA3LEE-840E-L1752-B*	998,00
1752	4000K	On/Off	Medium	4370lm/31W	4,6	LA3LWE-840M-L1752-B*	LA3LEE-840M-L1752-B*	998,00
1752	4000K	On/Off	High	6280lm/46W	4,6	LA3LWE-840H-L1752-B*	LA3LEE-840H-L1752-B*	998,00
2002	4000K	On/Off	Low	3660lm/25W	5,5	LA3LWE-840E-L2002-B*	LA3LEE-840E-L2002-B*	1217,00
2002	4000K	On/Off	Medium	5000lm/35W	5,5	LA3LWE-840M-L2002-B*	LA3LEE-840M-L2002-B*	1217,00
2002	4000K	On/Off	High	7180lm/53W	5,5	LA3LWE-840H-L2002-B*	LA3LEE-840H-L2002-B*	1217,00
per meter	4000K	On/Off	Low	1830lm/12,3W	2,9	LA3LWE-840E-L****-B*	LA3LEE-840E-L****-B*	
per meter	4000K	On/Off	Medium	2500lm/17,3W	2,9	LA3LWE-840M-L****-B*	LA3LEE-840M-L****-B*	604,00
per meter	4000K	On/Off	High	3600lm/26,4W	2,9	LA3LWE-840H-L****-B*	LA3LEE-840H-L****-B*	604,00
per meter	4000K	DALI	Low	1830lm/12,3W	2,9	LA3LWL-840E-L****-B*	LA3LEL-840E-L****-B*	
per meter	4000K	DALI	Medium	2500lm/17,3W	2,9	LA3LWL-840M-L****-B*	LA3LEL-840M-L****-B*	657,00
per meter	4000K	DALI	High	3600lm/26,4W	2,9	LA3LWL-840H-L****-B*	LA3LEL-840H-L****-B*	657,00

Microprismatic | Direct

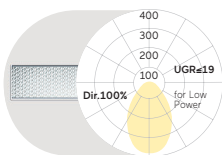

L mm	Colour Temperature	Control	Power	Lumen/Watt	Weight kg	Code Snow White	Code Silver Anodised	CHF
600	4000K	On/Off	Low	820lm/9W	1,8	LA3AWE-840E-L600	LA3AEE-840E-L600	419,00
600	4000K	On/Off	Medium	1110lm/12W	1,8	LA3AWE-840M-L600	LA3AEE-840M-L600	419,00
600	4000K	On/Off	High	1570lm/17W	1,8	LA3AWE-840H-L600	LA3AEE-840H-L600	419,00
890	4000K	On/Off	Low	1230lm/12W	2,4	LA3AWE-840E-L890	LA3AEE-840E-L890	462,00
890	4000K	On/Off	Medium	1660lm/16W	2,4	LA3AWE-840M-L890	LA3AEE-840M-L890	462,00
890	4000K	On/Off	High	2350lm/24W	2,4	LA3AWE-840H-L890	LA3AEE-840H-L890	462,00
1182	4000K	On/Off	Low	1640lm/16W	3,0	LA3AWE-840E-L1182	LA3AEE-840E-L1182	497,00
1182	4000K	On/Off	Medium	2210lm/21W	3,0	LA3AWE-840M-L1182	LA3AEE-840M-L1182	497,00
1182	4000K	On/Off	High	3130lm/31W	3,0	LA3AWE-840H-L1182	LA3AEE-840H-L1182	497,00
1475	4000K	On/Off	Low	2050lm/19W	3,7	LA3AWE-840E-L1475	LA3AEE-840E-L1475	578,00
1475	4000K	On/Off	Medium	2770lm/26W	3,7	LA3AWE-840M-L1475	LA3AEE-840M-L1475	578,00
1475	4000K	On/Off	High	3920lm/37W	3,7	LA3AWE-840H-L1475	LA3AEE-840H-L1475	578,00
1765	4000K	On/Off	Low	2450lm/22W	4,3	LA3AWE-840E-L1765	LA3AEE-840E-L1765	718,00
1765	4000K	On/Off	Medium	3320lm/30W	4,3	LA3AWE-840M-L1765	LA3AEE-840M-L1765	718,00
1765	4000K	On/Off	High	4700lm/44W	4,3	LA3AWE-840H-L1765	LA3AEE-840H-L1765	718,00
2055	4000K	On/Off	Low	2860lm/28W	5,2	LA3AWE-840E-L2055	LA3AEE-840E-L2055	900,00
2055	4000K	On/Off	Medium	3870lm/38W	5,2	LA3AWE-840M-L2055	LA3AEE-840M-L2055	900,00
2055	4000K	On/Off	High	5490lm/54W	5,2	LA3AWE-840H-L2055	LA3AEE-840H-L2055	900,00
per meter	4000K	On/Off	Low	1390lm/12,5W	2,6	LA3AWE-840E-L****	LA3AEE-840E-L****	438,00
per meter	4000K	On/Off	Medium	1880lm/17,2W	2,6	LA3AWE-840M-L****	LA3AEE-840M-L****	438,00
per meter	4000K	On/Off	High	2670lm/25,2W	2,6	LA3AWE-840H-L****	LA3AEE-840H-L****	438,00
per meter	4000K	DALI	Low	1390lm/12,5W	2,6	LA3AWL-840E-L****	LA3AEL-840E-L****	490,00
per meter	4000K	DALI	Medium	1880lm/17,2W	2,6	LA3AWL-840M-L****	LA3AEL-840M-L****	490,00
per meter	4000K	DALI	High	2670lm/25,2W	2,6	LA3AWL-840H-L****	LA3AEL-840H-L****	490,00

**** Your length in mm

Meterpreise für Lichtsysteme nach Maß ab Mindestlänge 2200mm | Prices per metre for customised lighting systems with a minimum length of 2200mm
 Prix au mètre pour systèmes d'éclairage sur mesure à partir d'une longueur minimale de 2200mm

... Matric A3 | System 55mm Surface

Opal Diffuser | Direct

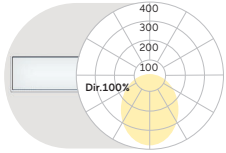

L mm	Colour Temperature	Control	Power	Lumen/Watt	Weight kg	Code Snow White	Code Silver Anodised	CHF
600	4000K	On/Off	Low	900lm/9W	1,8	LA3OWE-840E-L600	LA3OEE-840E-L600	401,00
600	4000K	On/Off	Medium	1210lm/12W	1,8	LA3OWE-840M-L600	LA3OEE-840M-L600	401,00
600	4000K	On/Off	High	1720lm/17W	1,8	LA3OWE-840H-L600	LA3OEE-840H-L600	401,00
890	4000K	On/Off	Low	1350lm/12W	2,4	LA3OWE-840E-L890	LA3OEE-840E-L890	445,00
890	4000K	On/Off	Medium	1820lm/16W	2,4	LA3OWE-840M-L890	LA3OEE-840M-L890	445,00
890	4000K	On/Off	High	2580lm/24W	2,4	LA3OWE-840H-L890	LA3OEE-840H-L890	445,00
1182	4000K	On/Off	Low	1790lm/16W	3,0	LA3OWE-840E-L1182	LA3OEE-840E-L1182	473,00
1182	4000K	On/Off	Medium	2430lm/21W	3,0	LA3OWE-840M-L1182	LA3OEE-840M-L1182	473,00
1182	4000K	On/Off	High	3440lm/31W	3,0	LA3OWE-840H-L1182	LA3OEE-840H-L1182	473,00
1475	4000K	On/Off	Low	2240lm/19W	3,7	LA3OWE-840E-L1475	LA3OEE-840E-L1475	543,00
1475	4000K	On/Off	Medium	3030lm/26W	3,7	LA3OWE-840M-L1475	LA3OEE-840M-L1475	543,00
1475	4000K	On/Off	High	4300lm/37W	3,7	LA3OWE-840H-L1475	LA3OEE-840H-L1475	543,00
1765	4000K	On/Off	Low	2690lm/22W	4,3	LA3OWE-840E-L1765	LA3OEE-840E-L1765	672,00
1765	4000K	On/Off	Medium	3640lm/30W	4,3	LA3OWE-840M-L1765	LA3OEE-840M-L1765	672,00
1765	4000K	On/Off	High	5160lm/44W	4,3	LA3OWE-840H-L1765	LA3OEE-840H-L1765	672,00
2055	4000K	On/Off	Low	3140lm/28W	5,2	LA3OWE-840E-L2055	LA3OEE-840E-L2055	830,00
2055	4000K	On/Off	Medium	4250lm/38W	5,2	LA3OWE-840M-L2055	LA3OEE-840M-L2055	830,00
2055	4000K	On/Off	High	6020lm/54W	5,2	LA3OWE-840H-L2055	LA3OEE-840H-L2055	830,00
per meter	4000K	On/Off	Low	1530lm/12,5W	2,6	LA3OWE-840E-L****	LA3OEE-840E-L****	412,00
per meter	4000K	On/Off	Medium	2060lm/17,2W	2,6	LA3OWE-840M-L****	LA3OEE-840M-L****	412,00
per meter	4000K	On/Off	High	2930lm/25,2W	2,6	LA3OWE-840H-L****	LA3OEE-840H-L****	412,00
per meter	4000K	DALI	Low	1530lm/12,5W	2,6	LA3OWL-840E-L****	LA3OEL-840E-L****	464,00
per meter	4000K	DALI	Medium	2060lm/17,2W	2,6	LA3OWL-840M-L****	LA3OEL-840M-L****	464,00
per meter	4000K	DALI	High	2930lm/25,2W	2,6	LA3OWL-840H-L****	LA3OEL-840H-L****	464,00

Wallwasher | Direct

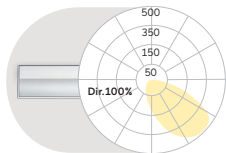

L mm	Colour Temperature	Control	Power	Lumen/Watt	Weight kg	Code Snow White	Code Silver Anodised	CHF
600	4000K	On/Off	Medium	750lm/11W	1,8	LA3GWE-840M-L600	LA3GEE-840M-L600	454,00
600	4000K	On/Off	High	1030lm/15W	1,8	LA3GWE-840H-L600	LA3GEE-840H-L600	454,00
890	4000K	On/Off	Medium	1130lm/15W	2,5	LA3GWE-840M-L890	LA3GEE-840M-L890	489,00
890	4000K	On/Off	High	1540lm/21W	2,5	LA3GWE-840H-L890	LA3GEE-840H-L890	489,00
1182	4000K	On/Off	Medium	1500lm/19W	3,2	LA3GWE-840M-L1182	LA3GEE-840M-L1182	541,00
1182	4000K	On/Off	High	2060lm/27W	3,2	LA3GWE-840H-L1182	LA3GEE-840H-L1182	541,00
1475	4000K	On/Off	Medium	1880lm/23W	3,8	LA3GWE-840M-L1475	LA3GEE-840M-L1475	622,00
1475	4000K	On/Off	High	2570lm/33W	3,8	LA3GWE-840H-L1475	LA3GEE-840H-L1475	622,00
1765	4000K	On/Off	Medium	2250lm/28W	4,5	LA3GWE-840M-L1765	LA3GEE-840M-L1765	770,00
1765	4000K	On/Off	High	3090lm/39W	4,5	LA3GWE-840H-L1765	LA3GEE-840H-L1765	770,00
2055	4000K	On/Off	Medium	2630lm/34W	5,4	LA3GWE-840M-L2055	LA3GEE-840M-L2055	952,00
2055	4000K	On/Off	High	3600lm/47W	5,4	LA3GWE-840H-L2055	LA3GEE-840H-L2055	952,00
per meter	4000K	On/Off	Medium	1280lm/15,6W	2,7	LA3GWE-840M-L****	LA3GEE-840M-L****	464,00
per meter	4000K	On/Off	High	1750lm/21,9W	2,7	LA3GWE-840H-L****	LA3GEE-840H-L****	464,00
per meter	4000K	DALI	Medium	1280lm/15,6W	2,7	LA3GWL-840M-L****	LA3GEL-840M-L****	517,00
per meter	4000K	DALI	High	1750lm/21,9W	2,7	LA3GWL-840H-L****	LA3GEL-840H-L****	517,00

**** Your length in mm

Meterpreise für Lichtsysteme nach Maß ab Mindestlänge 2200mm | Prices per metre for customised lighting systems with a minimum length of 2200mm
 Prix au mètre pour systèmes d'éclairage sur mesure à partir d'une longueur minimale de 2200mm



90° Corner
Opal/Microprismatic

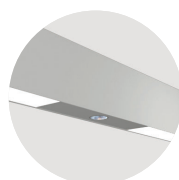

Midpin-Downlight XD
770lm/10W/Ø40mm



Midpin Spotlight XM
770lm/10W/Ø40mm

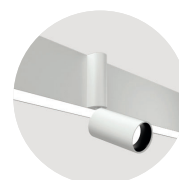

Midpin Spotlight XP
770lm/10W/Ø40mm



3-Phase Track



Multisensor

Surcharges

Optical System	CHF	Surface Finish	CHF	Control Gear	CHF L600-L1765	CHF L2055	Colour Temperature	CHF	Lens Louve*	CHF
O: Opal Diffuser (PMMA)	✓	W: Snow White	✓	E: On/Off	✓	✓	22: 2200K	+5%	W: Snow White	✓
D: Opal Diffuser Polycarbonate*	+5%	V: Ivory White	✓	L: DALI	+86,00	+172,00	27: 2700K	+5%	A: Satin Silver	✓
		E: Silver Anodised	✓	H: Touch-Dim	+86,00	+172,00	30: 3000K	✓	B: Jet Black	✓
		U: Urban Graphite	✓	C: Casambi	+261,00	+261,00	35: 3500K	+5%	H: Anodic Champagne	✓
		B: Jet Black	✓	6: DALI DT6 for TW	+172,00	+343,00	40: 4000K	✓	K: Satin Copper	✓
		H: Anodic Champagne	+10%	8: DALI DT8 for TW	+172,00	+343,00	65: 6500K	+5%	G: Satin Gold	✓
		K: Satin Copper	+15%				TW: Tunable White 2700-6500K** [L1182-L2055]	+30%		
		R: Special RAL/NCS Colours	ⓘ	*Only in combination with DALI. Please add to dimming price.					Additional Options	CHF
				Colour Rendering	CHF				90° Corner	ⓘ
				8: CRI>80	✓				Midpin Downlight XD	+363,00
				9: CRI>90	+5%				Midpin Spotlight XM	+363,00
				F: Full Spectrum	+15%				Midpin Spotlight XP	+433,00
									Multisensor [L1182-L2055]	+261,00
									Emergency Module [DALI, Autotest, incl. 3H Battery] [L1182-L2055]	+366,00

✓ standard / no extra charge ⓘ on request ✗ not available

Matric A5 | System 81mm Surface

catalogue page 422

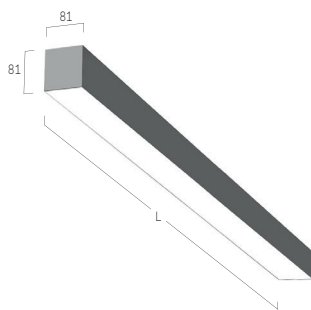
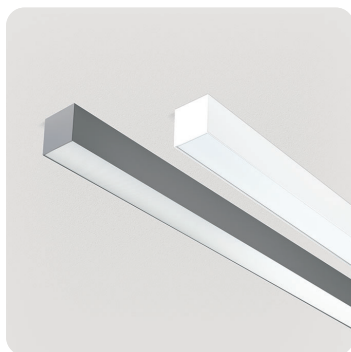

Microprismatic | Direct

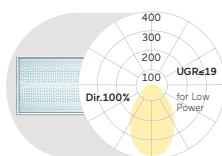

L mm	Colour Temperature	Control	Power	Lumen/Watt	Weight kg	Code Snow White	Code Silver Anodised	CHF
600	4000K	On/Off	Low	1000lm/11W	2,4	LA5AWE-840E-L600	LA5AEE-840E-L600	429,00
600	4000K	On/Off	Medium	1380lm/15W	2,4	LA5AWE-840M-L600	LA5AEE-840M-L600	429,00
600	4000K	On/Off	High	2010lm/21W	2,4	LA5AWE-840H-L600	LA5AEE-840H-L600	429,00
890	4000K	On/Off	Low	1510lm/15W	3,2	LA5AWE-840E-L890	LA5AEE-840E-L890	480,00
890	4000K	On/Off	Medium	2070lm/21W	3,2	LA5AWE-840M-L890	LA5AEE-840M-L890	480,00
890	4000K	On/Off	High	3020lm/31W	3,2	LA5AWE-840H-L890	LA5AEE-840H-L890	480,00
1182	4000K	On/Off	Low	2010lm/19W	4,0	LA5AWE-840E-L1182	LA5AEE-840E-L1182	527,00
1182	4000K	On/Off	Medium	2760lm/26W	4,0	LA5AWE-840M-L1182	LA5AEE-840M-L1182	527,00
1182	4000K	On/Off	High	4020lm/40W	4,0	LA5AWE-840H-L1182	LA5AEE-840H-L1182	527,00
1475	4000K	On/Off	Low	2510lm/23W	4,8	LA5AWE-840E-L1475	LA5AEE-840E-L1475	613,00
1475	4000K	On/Off	Medium	3450lm/32W	4,8	LA5AWE-840M-L1475	LA5AEE-840M-L1475	613,00
1475	4000K	On/Off	High	5030lm/49W	4,8	LA5AWE-840H-L1475	LA5AEE-840H-L1475	613,00
1765	4000K	On/Off	Low	3010lm/27W	5,6	LA5AWE-840E-L1765	LA5AEE-840E-L1765	770,00
1765	4000K	On/Off	Medium	4140lm/38W	5,6	LA5AWE-840M-L1765	LA5AEE-840M-L1765	770,00
1765	4000K	On/Off	High	6030lm/59W	5,6	LA5AWE-840H-L1765	LA5AEE-840H-L1765	770,00
2055	4000K	On/Off	Low	3510lm/34W	6,7	LA5AWE-840E-L2055	LA5AEE-840E-L2055	963,00
2055	4000K	On/Off	Medium	4830lm/47W	6,7	LA5AWE-840M-L2055	LA5AEE-840M-L2055	963,00
2055	4000K	On/Off	High	7040lm/71W	6,7	LA5AWE-840H-L2055	LA5AEE-840H-L2055	963,00
per meter	4000K	On/Off	Low	1710lm/15,5W	3,5	LA5AWE-840E-L****	LA5AEE-840E-L****	482,00
per meter	4000K	On/Off	Medium	2350lm/21,7W	3,5	LA5AWE-840M-L****	LA5AEE-840M-L****	482,00
per meter	4000K	On/Off	High	3420lm/33,3W	3,5	LA5AWE-840H-L****	LA5AEE-840H-L****	482,00
per meter	4000K	DALI	Low	1710lm/15,5W	3,5	LA5AWL-840E-L****	LA5AEL-840E-L****	534,00
per meter	4000K	DALI	Medium	2350lm/21,7W	3,5	LA5AWL-840M-L****	LA5AEL-840M-L****	534,00
per meter	4000K	DALI	High	3420lm/33,3W	3,5	LA5AWL-840H-L****	LA5AEL-840H-L****	534,00

Opal Diffuser | Direct

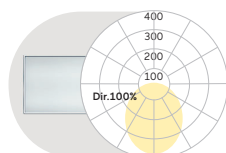

L mm	Colour Temperature	Control	Power	Lumen/Watt	Weight kg	Code Snow White	Code Silver Anodised	CHF
600	4000K	On/Off	Low	1180lm/11W	2,4	LA5OWE-840E-L600	LA5OEE-840E-L600	412,00
600	4000K	On/Off	Medium	1620lm/15W	2,4	LA5OWE-840M-L600	LA5OEE-840M-L600	412,00
600	4000K	On/Off	High	2360lm/21W	2,4	LA5OWE-840H-L600	LA5OEE-840H-L600	412,00
890	4000K	On/Off	Low	1760lm/15W	3,2	LA5OWE-840E-L890	LA5OEE-840E-L890	462,00
890	4000K	On/Off	Medium	2430lm/21W	3,2	LA5OWE-840M-L890	LA5OEE-840M-L890	462,00
890	4000K	On/Off	High	3530lm/31W	3,2	LA5OWE-840H-L890	LA5OEE-840H-L890	462,00
1182	4000K	On/Off	Low	2350lm/19W	4,0	LA5OWE-840E-L1182	LA5OEE-840E-L1182	499,00
1182	4000K	On/Off	Medium	3230lm/26W	4,0	LA5OWE-840M-L1182	LA5OEE-840M-L1182	499,00
1182	4000K	On/Off	High	4710lm/40W	4,0	LA5OWE-840H-L1182	LA5OEE-840H-L1182	499,00
1475	4000K	On/Off	Low	2940lm/23W	4,8	LA5OWE-840E-L1475	LA5OEE-840E-L1475	578,00
1475	4000K	On/Off	Medium	4040lm/32W	4,8	LA5OWE-840M-L1475	LA5OEE-840M-L1475	578,00
1475	4000K	On/Off	High	5890lm/49W	4,8	LA5OWE-840H-L1475	LA5OEE-840H-L1475	578,00
1765	4000K	On/Off	Low	3530lm/27W	5,6	LA5OWE-840E-L1765	LA5OEE-840E-L1765	725,00
1765	4000K	On/Off	Medium	4850lm/38W	5,6	LA5OWE-840M-L1765	LA5OEE-840M-L1765	725,00
1765	4000K	On/Off	High	7070lm/59W	5,6	LA5OWE-840H-L1765	LA5OEE-840H-L1765	725,00
2055	4000K	On/Off	Low	4120lm/34W	6,7	LA5OWE-840E-L2055	LA5OEE-840E-L2055	900,00
2055	4000K	On/Off	Medium	5660lm/47W	6,7	LA5OWE-840M-L2055	LA5OEE-840M-L2055	900,00
2055	4000K	On/Off	High	8240lm/71W	6,7	LA5OWE-840H-L2055	LA5OEE-840H-L2055	900,00
per meter	4000K	On/Off	Low	2000lm/15,5W	3,5	LA5OWE-840E-L****	LA5OEE-840E-L****	447,00
per meter	4000K	On/Off	Medium	2750lm/21,7W	3,5	LA5OWE-840M-L****	LA5OEE-840M-L****	447,00
per meter	4000K	On/Off	High	4010lm/33,3W	3,5	LA5OWE-840H-L****	LA5OEE-840H-L****	447,00
per meter	4000K	DALI	Low	2000lm/15,5W	3,5	LA5OWL-840E-L****	LA5OEL-840E-L****	499,00
per meter	4000K	DALI	Medium	2750lm/21,7W	3,5	LA5OWL-840M-L****	LA5OEL-840M-L****	499,00
per meter	4000K	DALI	High	4010lm/33,3W	3,5	LA5OWL-840H-L****	LA5OEL-840H-L****	499,00

**** Your length in mm
 Meterpreise für Lichtsysteme nach Maß ab Mindestlänge 2200mm | Prices per metre for customised lighting systems with a minimum length of 2200mm
 Prix au mètre pour systèmes d'éclairage sur mesure à partir d'une longueur minimale de 2200mm

... Matric A5 | System 81mm Surface

Satin Louvre | Direct

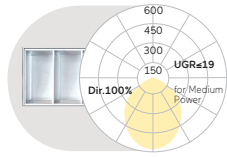

L mm	Colour Temperature	Control	Power	Lumen/Watt	Weight kg	Code Snow White	Code Silver Anodised	CHF
600	4000K	On/Off	Medium	1270lm/15W	2,4	LA5MWE-840M-L600	LA5MEE-840M-L600	436,00
600	4000K	On/Off	High	1840lm/21W	2,4	LA5MWE-840H-L600	LA5MEE-840H-L600	436,00
890	4000K	On/Off	Medium	1900lm/21W	3,2	LA5MWE-840M-L890	LA5MEE-840M-L890	506,00
890	4000K	On/Off	High	2770lm/31W	3,2	LA5MWE-840H-L890	LA5MEE-840H-L890	506,00
1182	4000K	On/Off	Medium	2530lm/26W	4,1	LA5MWE-840M-L1182	LA5MEE-840M-L1182	553,00
1182	4000K	On/Off	High	3690lm/40W	4,1	LA5MWE-840H-L1182	LA5MEE-840H-L1182	553,00
1475	4000K	On/Off	Medium	3170lm/32W	4,9	LA5MWE-840M-L1475	LA5MEE-840M-L1475	615,00
1475	4000K	On/Off	High	4610lm/49W	4,9	LA5MWE-840H-L1475	LA5MEE-840H-L1475	615,00
1765	4000K	On/Off	Medium	3800lm/38W	5,8	LA5MWE-840M-L1765	LA5MEE-840M-L1765	709,00
1765	4000K	On/Off	High	5530lm/59W	5,8	LA5MWE-840H-L1765	LA5MEE-840H-L1765	709,00
2055	4000K	On/Off	Medium	4430lm/47W	6,8	LA5MWE-840M-L2055	LA5MEE-840M-L2055	903,00
2055	4000K	On/Off	High	6450lm/71W	6,8	LA5MWE-840H-L2055	LA5MEE-840H-L2055	903,00

Wallwasher | Direct

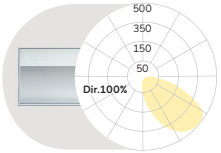

L mm	Colour Temperature	Control	Power	Lumen/Watt	Weight kg	Code Snow White	Code Silver Anodised	CHF
600	4000K	On/Off	High	1180lm/15W	2,4	LA5GWE-840H-L600	LA5GEE-840H-L600	489,00
890	4000K	On/Off	High	1770lm/21W	3,2	LA5GWE-840H-L890	LA5GEE-840H-L890	506,00
1182	4000K	On/Off	High	2360lm/27W	4,1	LA5GWE-840H-L1182	LA5GEE-840H-L1182	553,00
1475	4000K	On/Off	High	2950lm/33W	4,9	LA5GWE-840H-L1475	LA5GEE-840H-L1475	615,00
1765	4000K	On/Off	High	3540lm/39W	5,8	LA5GWE-840H-L1765	LA5GEE-840H-L1765	779,00
2055	4000K	On/Off	High	4130lm/47W	6,8	LA5GWE-840H-L2055	LA5GEE-840H-L2055	989,00
per meter	4000K	On/Off	High	2010lm/21,9W	3,5	LA5GWE-840H-L****	LA5GEE-840H-L****	473,00
per meter	4000K	DALI	High	2010lm/21,9W	3,5	LA5GWL-840H-L****	LA5GEL-840H-L****	525,00

**** Your length in mm

Meterpreise für Lichtsysteme nach Maß ab Mindestlänge 2200mm | Prices per metre for customised lighting systems with a minimum length of 2200mm
 Prix au mètre pour systèmes d'éclairage sur mesure à partir d'une longueur minimale de 2200mm



90° Corner
Opal/Microprismatic

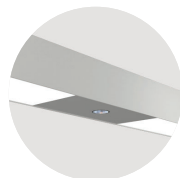

Midpin Downlight XD
770lm/10W/Ø40mm



Midpin Spotlight XM
770lm/10W/Ø40mm

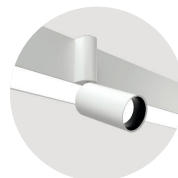

Midpin Spotlight XP
770lm/10W/Ø40mm



Midpoint Spotlight XP
1000lm/19W-3000lm/31W
Ø90mm



Multisensor

Surcharges

Surface Finish	CHF	Control Gear	CHF	CHF	Colour Temperature	CHF	Additional Options	CHF
W: Snow White	✓	E: On/Off	L600-L1765	L2055	22: 2200K	+5%	90° Corner	ⓘ
V: Ivory White	✓	L: DALI	+86,00	+172,00	27: 2700K	+5%	Midpin Downlight XD	+363,00
E: Silver Anodised	✓	H: Touch-Dim	+86,00	+172,00	30: 3000K	✓	Midpin Spotlight XM	+363,00
U: Urban Graphite	✓	C: Casambi*	+261,00	+261,00	35: 3500K	+5%	Midpin Spotlight XP	+433,00
B: Jet Black	✓	6: DALI DT6 for TW	+172,00	+343,00	40: 4000K	✓	Midpoint Spotlight XM	+368,00
H: Anodic Champagne	+10%	8: DALI DT8 for TW	+172,00	+343,00	65: 6500K	+5%	Midpoint Spotlight XP	+489,00
K: Satin Copper	+15%	*Only in combination with DALI. Please add to dimming price.			TW: Tunable White 2700-6500K* [L890-L2055]	+30%	Multisensor [L1182-L2055]	+261,00
R: Special RAL/NCS Colours	ⓘ	Colour Rendering		CHF	*Only in combination with DT6, DT8 or Casambi control. Please add additional control price.		Emergency Module [DALI, Autotest, incl. 3H Battery] [L1182-L2055]	+366,00
		8: CRI>80		✓				
		9: CRI>90		+5%				
		F: Full Spectrum		+15%				

✓ standard / no extra charge ⓘ on request ✗ not available

Matric A6 | System 81mm Surface

catalogue page 424

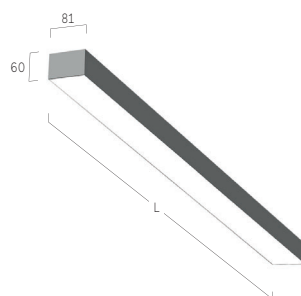
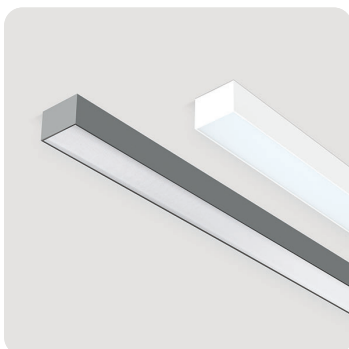

Microprismatic | Direct

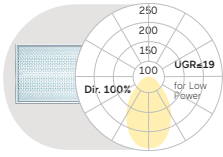

L mm	Colour Temperature	Control	Power	Lumen/Watt	Weight kg	Code Snow White	Code Silver Anodised	CHF
600	4000K	On/Off	Low	1030lm/10W	2,0	LA6AWE-840E-L600	LA6AEE-840E-L600	595,00
600	4000K	On/Off	Medium	1420lm/14W	2,0	LA6AWE-840M-L600	LA6AEE-840M-L600	595,00
600	4000K	On/Off	High	2000lm/19W	2,0	LA6AWE-840H-L600	LA6AEE-840H-L600	595,00
890	4000K	On/Off	Low	1580lm/15W	2,7	LA6AWE-840E-L890	LA6AEE-840E-L890	637,00
890	4000K	On/Off	Medium	2110lm/19W	2,7	LA6AWE-840M-L890	LA6AEE-840M-L890	637,00
890	4000K	On/Off	High	2840lm/26W	2,7	LA6AWE-840H-L890	LA6AEE-840H-L890	637,00
1182	4000K	On/Off	Low	2100lm/19W	3,4	LA6AWE-840E-L1182	LA6AEE-840E-L1182	700,00
1182	4000K	On/Off	Medium	2810lm/25W	3,4	LA6AWE-840M-L1182	LA6AEE-840M-L1182	700,00
1182	4000K	On/Off	High	3790lm/34W	3,4	LA6AWE-840H-L1182	LA6AEE-840H-L1182	700,00
1475	4000K	On/Off	Low	2630lm/23W	4,1	LA6AWE-840E-L1475	LA6AEE-840E-L1475	786,00
1475	4000K	On/Off	Medium	3510lm/31W	4,1	LA6AWE-840M-L1475	LA6AEE-840M-L1475	786,00
1475	4000K	On/Off	High	4740lm/42W	4,1	LA6AWE-840H-L1475	LA6AEE-840H-L1475	786,00
1765	4000K	On/Off	Low	3150lm/27W	4,9	LA6AWE-840E-L1765	LA6AEE-840E-L1765	891,00
1765	4000K	On/Off	Medium	4220lm/36W	4,9	LA6AWE-840M-L1765	LA6AEE-840M-L1765	891,00
1765	4000K	On/Off	High	5690lm/49W	4,9	LA6AWE-840H-L1765	LA6AEE-840H-L1765	891,00
2055	4000K	On/Off	Low	3680lm/31W	5,8	LA6AWE-840E-L2055	LA6AEE-840E-L2055	1127,00
2055	4000K	On/Off	Medium	4920lm/42W	5,8	LA6AWE-840M-L2055	LA6AEE-840M-L2055	1127,00
2055	4000K	On/Off	High	6640lm/57W	5,8	LA6AWE-840H-L2055	LA6AEE-840H-L2055	1127,00
per meter	4000K	On/Off	Low	1790lm/15,1W	3,0	LA6AWE-840E-L****	LA6AEE-840E-L****	543,00
per meter	4000K	On/Off	Medium	2400lm/20,2W	3,0	LA6AWE-840M-L****	LA6AEE-840M-L****	543,00
per meter	4000K	On/Off	High	3240lm/27,4W	3,0	LA6AWE-840H-L****	LA6AEE-840H-L****	543,00
per meter	4000K	DALI	Low	1790lm/15,1W	3,0	LA6AWL-840E-L****	LA6AEL-840E-L****	595,00
per meter	4000K	DALI	Medium	2400lm/20,2W	3,0	LA6AWL-840M-L****	LA6AEL-840M-L****	595,00
per meter	4000K	DALI	High	3240lm/27,4W	3,0	LA6AWL-840H-L****	LA6AEL-840H-L****	595,00

Opal Diffuser | Direct

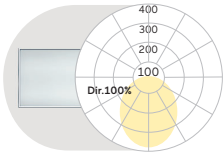

L mm	Colour Temperature	Control	Power	Lumen/Watt	Weight kg	Code Snow White	Code Silver Anodised	CHF
600	4000K	On/Off	Low	1250lm/10W	2,0	LA6OWE-840E-L600	LA6OEE-840E-L600	576,00
600	4000K	On/Off	Medium	1730lm/14W	2,0	LA6OWE-840M-L600	LA6OEE-840M-L600	576,00
600	4000K	On/Off	High	2430lm/19W	2,0	LA6OWE-840H-L600	LA6OEE-840H-L600	576,00
890	4000K	On/Off	Low	1920lm/15W	2,7	LA6OWE-840E-L890	LA6OEE-840E-L890	602,00
890	4000K	On/Off	Medium	2560lm/19W	2,7	LA6OWE-840M-L890	LA6OEE-840M-L890	602,00
890	4000K	On/Off	High	3460lm/26W	2,7	LA6OWE-840H-L890	LA6OEE-840H-L890	602,00
1182	4000K	On/Off	Low	2560lm/19W	3,4	LA6OWE-840E-L1182	LA6OEE-840E-L1182	648,00
1182	4000K	On/Off	Medium	3420lm/25W	3,4	LA6OWE-840M-L1182	LA6OEE-840M-L1182	648,00
1182	4000K	On/Off	High	4610lm/34W	3,4	LA6OWE-840H-L1182	LA6OEE-840H-L1182	648,00
1475	4000K	On/Off	Low	3200lm/23W	4,1	LA6OWE-840E-L1475	LA6OEE-840E-L1475	716,00
1475	4000K	On/Off	Medium	4270lm/31W	4,1	LA6OWE-840M-L1475	LA6OEE-840M-L1475	716,00
1475	4000K	On/Off	High	5760lm/42W	4,1	LA6OWE-840H-L1475	LA6OEE-840H-L1475	716,00
1765	4000K	On/Off	Low	3840lm/27W	4,9	LA6OWE-840E-L1765	LA6OEE-840E-L1765	804,00
1765	4000K	On/Off	Medium	5130lm/36W	4,9	LA6OWE-840M-L1765	LA6OEE-840M-L1765	804,00
1765	4000K	On/Off	High	6920lm/49W	4,9	LA6OWE-840H-L1765	LA6OEE-840H-L1765	804,00
2055	4000K	On/Off	Low	4470lm/31W	5,8	LA6OWE-840E-L2055	LA6OEE-840E-L2055	1014,00
2055	4000K	On/Off	Medium	5980lm/42W	5,8	LA6OWE-840M-L2055	LA6OEE-840M-L2055	1014,00
2055	4000K	On/Off	High	8070lm/57W	5,8	LA6OWE-840H-L2055	LA6OEE-840H-L2055	1014,00
per meter	4000K	On/Off	Low	2180lm/15,1W	3,0	LA6OWE-840E-L****	LA6OEE-840E-L****	499,00
per meter	4000K	On/Off	Medium	2920lm/20,2W	3,0	LA6OWE-840M-L****	LA6OEE-840M-L****	499,00
per meter	4000K	On/Off	High	3940lm/27,4W	3,0	LA6OWE-840H-L****	LA6OEE-840H-L****	499,00
per meter	4000K	DALI	Low	2180lm/15,1W	3,0	LA6OWL-840E-L****	LA6OEL-840E-L****	552,00
per meter	4000K	DALI	Medium	2920lm/20,2W	3,0	LA6OWL-840M-L****	LA6OEL-840M-L****	552,00
per meter	4000K	DALI	High	3940lm/27,4W	3,0	LA6OWL-840H-L****	LA6OEL-840H-L****	552,00

Wallwasher | Direct

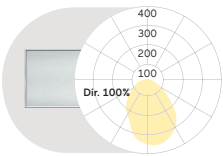

L mm	Colour Temperature	Control	Power	Lumen/Watt	Weight kg	Code Snow White	Code Silver Anodised	CHF
600	4000K	On/Off	Low	1080lm/10W	2,0	LA6JWE-840E-L600	LA6JEE-840E-L600	560,00
600	4000K	On/Off	Medium	1490lm/14W	2,0	LA6JWE-840M-L600	LA6JEE-840M-L600	560,00
600	4000K	On/Off	High	2100lm/19W	2,0	LA6JWE-840H-L600	LA6JEE-840H-L600	560,00
890	4000K	On/Off	Low	1650lm/15W	2,7	LA6JWE-840E-L890	LA6JEE-840E-L890	609,00
890	4000K	On/Off	Medium	2210lm/19W	2,7	LA6JWE-840M-L890	LA6JEE-840M-L890	609,00
890	4000K	On/Off	High	2980lm/26W	2,7	LA6JWE-840H-L890	LA6JEE-840H-L890	609,00
1182	4000K	On/Off	Low	2200lm/19W	3,4	LA6JWE-840E-L1182	LA6JEE-840E-L1182	671,00
1182	4000K	On/Off	Medium	2940lm/25W	3,4	LA6JWE-840M-L1182	LA6JEE-840M-L1182	671,00
1182	4000K	On/Off	High	3970lm/34W	3,4	LA6JWE-840H-L1182	LA6JEE-840H-L1182	671,00
1475	4000K	On/Off	Low	2750lm/23W	4,1	LA6JWE-840E-L1475	LA6JEE-840E-L1475	753,00
1475	4000K	On/Off	Medium	3680lm/31W	4,1	LA6JWE-840M-L1475	LA6JEE-840M-L1475	753,00
1475	4000K	On/Off	High	4960lm/42W	4,1	LA6JWE-840H-L1475	LA6JEE-840H-L1475	753,00
1765	4000K	On/Off	Low	3300lm/27W	4,9	LA6JWE-840E-L1765	LA6JEE-840E-L1765	853,00
1765	4000K	On/Off	Medium	4420lm/36W	4,9	LA6JWE-840M-L1765	LA6JEE-840M-L1765	853,00
1765	4000K	On/Off	High	5960lm/49W	4,9	LA6JWE-840H-L1765	LA6JEE-840H-L1765	853,00
2055	4000K	On/Off	Low	3850lm/31W	5,8	LA6JWE-840E-L2055	LA6JEE-840E-L2055	1080,00
2055	4000K	On/Off	Medium	5150lm/42W	5,8	LA6JWE-840M-L2055	LA6JEE-840M-L2055	1080,00
2055	4000K	On/Off	High	6950lm/57W	5,8	LA6JWE-840H-L2055	LA6JEE-840H-L2055	1080,00
per meter	4000K	On/Off	Low	1880lm/15,1W	3,0	LA6JWE-840E-L****	LA6JEE-840E-L****	525,00
per meter	4000K	On/Off	Medium	2520lm/20,2W	3,0	LA6JWE-840M-L****	LA6JEE-840M-L****	525,00
per meter	4000K	On/Off	High	3400lm/27,4W	3,0	LA6JWE-840H-L****	LA6JEE-840H-L****	525,00
per meter	4000K	DALI	Low	1880lm/15,1W	3,0	LA6JWL-840E-L****	LA6JEL-840E-L****	578,00
per meter	4000K	DALI	Medium	2520lm/20,2W	3,0	LA6JWL-840M-L****	LA6JEL-840M-L****	578,00
per meter	4000K	DALI	High	3400lm/27,4W	3,0	LA6JWL-840H-L****	LA6JEL-840H-L****	578,00

**** Your length in mm

Meterpreise für Lichtsysteme nach Maß ab Mindestlänge 2200mm | Prices per metre for customised lighting systems with a minimum length of 2200mm
 Prix au mètre pour systèmes d'éclairage sur mesure à partir d'une longueur minimale de 2200mm

... Matric A6 | System 81mm Surface



90° Corner
Opal/Microprismatic

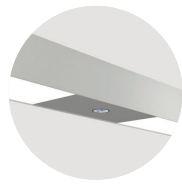

Midpin Downlight XD
770lm/10W/Ø40mm



Midpin Spotlight XM
770lm/10W/Ø40mm

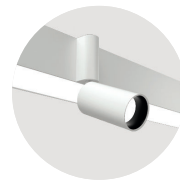

Midpin Spotlight XP
770lm/10W/Ø40mm



Midpoint Spotlight XP
1000lm/19W-3000lm/31W
Ø90mm



Multisensor

Surcharges

Surface Finish

Surface Finish	CHF
W: Snow White	✓
V: Ivory White	✓
E: Silver Anodised	✓
U: Urban Graphite	✓
B: Jet Black	✓
H: Anodic Champagne	+10%
K: Satin Copper	+15%
R: Special RAL/NCS Colours	ⓘ

Control Gear

Control Gear	CHF	CHF
E: On/Off	L600-L1765	L2055
L: DALI	+86,00	+172,00
H: Touch-Dim	+86,00	+172,00
C: Casambi*	+261,00	+261,00
6: DALI DT6 for TW	+172,00	+343,00
8: DALI DT8 for TW	+172,00	+343,00

*Only in combination with DALI.
Please add to dimming price.

Colour Rendering

Colour Rendering	CHF
8: CRI>80	✓
9: CRI>90	+5%
F: Full Spectrum	+15%

Colour Temperature

Colour Temperature	CHF
22: 2200K	+5%
27: 2700K	+5%
30: 3000K	✓
35: 3500K	+5%
40: 4000K	✓
65: 6500K	+5%
TW: Tunable White 2700-6500K* [L890-L2055]	+30%

*Only in combination with DT6, DT8 or
Casambi control. Please add additional
control price.

Additional Options

Additional Options	CHF
90° Corner	ⓘ
Midpin Downlight XD	+363,00
Midpin Spotlight XM	+363,00
Midpin Spotlight XP	+433,00
Midpoint Spotlight XM	+368,00
Midpoint Spotlight XP	+489,00
Multisensor [L1182-L2055]	+261,00
Emergency Module [DALI, Autotest, incl. 3H Battery] [L1182-L2055]	+366,00

✓ standard / no extra charge ⓘ on request ✗ not available

Vision Gen. 4 A4/X4 | Surface

catalogue page 426



X4 Direct-Indirect

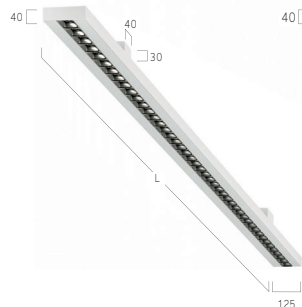

A4 Direct only

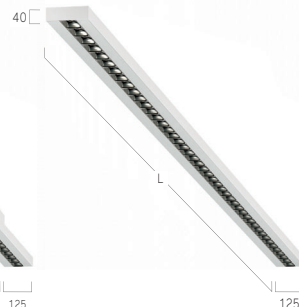

Lens Louvre | Direct-Indirect

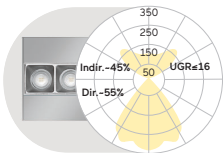

L mm	Colour Temperature	Control	Power	Lumen/Watt	Weight kg	Code Snow White/Jet Black	Code Silver Anodised/Jet Black	CHF
754	4000K	On/Off	Medium	3180lm/26W	2,4	VX4LWE-840M-L754-B*	VX4LEE-840M-L754-B*	692,00
754	4000K	On/Off	High	4480lm/36W	2,4	VX4LWE-840H-L754-B*	VX4LEE-840H-L754-B*	692,00
1004	4000K	On/Off	Medium	4470lm/34W	2,9	VX4LWE-840M-L1004-B*	VX4LEE-840M-L1004-B*	727,00
1004	4000K	On/Off	High	6270lm/48W	2,9	VX4LWE-840H-L1004-B*	VX4LEE-840H-L1004-B*	727,00
1254	4000K	On/Off	Medium	5750lm/42W	4,3	VX4LWE-840M-L1254-B*	VX4LEE-840M-L1254-B*	823,00
1254	4000K	On/Off	High	8080lm/61W	4,3	VX4LWE-840H-L1254-B*	VX4LEE-840H-L1254-B*	823,00
1504	4000K	On/Off	Medium	7040lm/50W	5,0	VX4LWE-840M-L1504-B*	VX4LEE-840M-L1504-B*	937,00
1504	4000K	On/Off	High	9850lm/73W	5,0	VX4LWE-840H-L1504-B*	VX4LEE-840H-L1504-B*	937,00
1754	4000K	On/Off	Medium	8310lm/58W	5,7	VX4LWE-840M-L1754-B*	VX4LEE-840M-L1754-B*	1077,00
1754	4000K	On/Off	High	11650lm/85W	5,7	VX4LWE-840H-L1754-B*	VX4LEE-840H-L1754-B*	1077,00
2004	4000K	On/Off	Medium	9600lm/69W	6,6	VX4LWE-840M-L2004-B*	VX4LEE-840M-L2004-B*	1252,00
2004	4000K	On/Off	High	13440lm/100W	6,6	VX4LWE-840H-L2004-B*	VX4LEE-840H-L2004-B*	1252,00
per meter	4000K	On/Off	Medium	4750lm/33,1W	2,9	VX4LWE-840M-L****-B*	VX4LEE-840M-L****-B*	639,00
per meter	4000K	On/Off	High	6670lm/48,6W	2,9	VX4LWE-840H-L****-B*	VX4LEE-840H-L****-B*	639,00
per meter	4000K	DALI	Medium	4750lm/33,1W	2,9	VX4LWL-840M-L****-B*	VX4LEL-840M-L****-B*	709,00
per meter	4000K	DALI	High	6670lm/48,6W	2,9	VX4LWL-840H-L****-B*	VX4LEL-840H-L****-B*	709,00

**** Your length in mm

Meterpreise für Lichtsysteme nach Maß ab Mindestlänge 2200mm | Prices per metre for customised lighting systems with a minimum length of 2200mm
Prix au mètre pour systèmes d'éclairage sur mesure à partir d'une longueur minimale de 2200mm

Microprismatic | Direct-Indirect

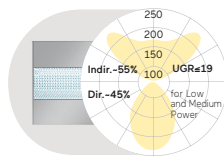

L mm	Colour Temperature	Control	Power	Lumen/Watt	Weight kg	Code Snow White	Code Silver Anodised	CHF
890	4000K	On/Off	Low	2640lm/23W	2,4	VX4AWE-840E-L890	VX4AEE-840E-L890	700,00
890	4000K	On/Off	Medium	3630lm/31W	2,4	VX4AWE-840M-L890	VX4AEE-840M-L890	700,00
890	4000K	On/Off	High	5030lm/43W	2,4	VX4AWE-840H-L890	VX4AEE-840H-L890	700,00
1182	4000K	On/Off	Low	3520lm/29W	2,9	VX4AWE-840E-L1182	VX4AEE-840E-L1182	779,00
1182	4000K	On/Off	Medium	4840lm/40W	2,9	VX4AWE-840M-L1182	VX4AEE-840M-L1182	779,00
1182	4000K	On/Off	High	6710lm/56W	2,9	VX4AWE-840H-L1182	VX4AEE-840H-L1182	779,00
1475	4000K	On/Off	Low	4400lm/35W	3,4	VX4AWE-840E-L1475	VX4AEE-840E-L1475	875,00
1475	4000K	On/Off	Medium	6060lm/48W	3,4	VX4AWE-840M-L1475	VX4AEE-840M-L1475	875,00
1475	4000K	On/Off	High	8390lm/69W	3,4	VX4AWE-840H-L1475	VX4AEE-840H-L1475	875,00
1765	4000K	On/Off	Low	5270lm/41W	3,9	VX4AWE-840E-L1765	VX4AEE-840E-L1765	998,00
1765	4000K	On/Off	Medium	7260lm/57W	3,9	VX4AWE-840M-L1765	VX4AEE-840M-L1765	998,00
1765	4000K	On/Off	High	10070lm/82W	3,9	VX4AWE-840H-L1765	VX4AEE-840H-L1765	998,00
2055	4000K	On/Off	Low	6150lm/52W	4,7	VX4AWE-840E-L2055	VX4AEE-840E-L2055	1155,00
2055	4000K	On/Off	Medium	8470lm/71W	4,7	VX4AWE-840M-L2055	VX4AEE-840M-L2055	1155,00
2055	4000K	On/Off	High	11750lm/99W	4,7	VX4AWE-840H-L2055	VX4AEE-840H-L2055	1155,00
per meter	4000K	On/Off	Low	2990lm/23,4W	2,6	VX4AWE-840E-L****	VX4AEE-840E-L****	595,00
per meter	4000K	On/Off	Medium	4120lm/32,3W	2,6	VX4AWE-840M-L****	VX4AEE-840M-L****	595,00
per meter	4000K	On/Off	High	5710lm/46,3W	2,6	VX4AWE-840H-L****	VX4AEE-840H-L****	595,00
per meter	4000K	DALI	Low	2990lm/23,4W	2,6	VX4AWL-840E-L****	VX4AEL-840E-L****	665,00
per meter	4000K	DALI	Medium	4120lm/32,3W	2,6	VX4AWL-840M-L****	VX4AEL-840M-L****	665,00
per meter	4000K	DALI	High	5710lm/46,3W	2,6	VX4AWL-840H-L****	VX4AEL-840H-L****	665,00

Opal Diffuser | Direct-Indirect

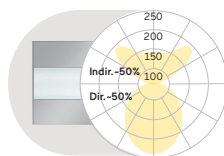

L mm	Colour Temperature	Control	Power	Lumen/Watt	Weight kg	Code Snow White	Code Silver Anodised	CHF
890	4000K	On/Off	Low	2760lm/23W	2,4	VX4OWE-840E-L890	VX4OEE-840E-L890	683,00
890	4000K	On/Off	Medium	3790lm/31W	2,4	VX4OWE-840M-L890	VX4OEE-840M-L890	683,00
890	4000K	On/Off	High	5260lm/43W	2,4	VX4OWE-840H-L890	VX4OEE-840H-L890	683,00
1182	4000K	On/Off	Low	3670lm/29W	2,9	VX4OWE-840E-L1182	VX4OEE-840E-L1182	744,00
1182	4000K	On/Off	Medium	5060lm/40W	2,9	VX4OWE-840M-L1182	VX4OEE-840M-L1182	744,00
1182	4000K	On/Off	High	7020lm/56W	2,9	VX4OWE-840H-L1182	VX4OEE-840H-L1182	744,00
1475	4000K	On/Off	Low	4590lm/35W	3,4	VX4OWE-840E-L1475	VX4OEE-840E-L1475	832,00
1475	4000K	On/Off	Medium	6320lm/48W	3,4	VX4OWE-840M-L1475	VX4OEE-840M-L1475	832,00
1475	4000K	On/Off	High	8770lm/69W	3,4	VX4OWE-840H-L1475	VX4OEE-840H-L1475	832,00
1765	4000K	On/Off	Low	5510lm/41W	3,9	VX4OWE-840E-L1765	VX4OEE-840E-L1765	945,00
1765	4000K	On/Off	Medium	7580lm/57W	3,9	VX4OWE-840M-L1765	VX4OEE-840M-L1765	945,00
1765	4000K	On/Off	High	10530lm/82W	3,9	VX4OWE-840H-L1765	VX4OEE-840H-L1765	945,00
2055	4000K	On/Off	Low	6430lm/52W	4,7	VX4OWE-840E-L2055	VX4OEE-840E-L2055	1085,00
2055	4000K	On/Off	Medium	8850lm/71W	4,7	VX4OWE-840M-L2055	VX4OEE-840M-L2055	1085,00
2055	4000K	On/Off	High	12280lm/99W	4,7	VX4OWE-840H-L2055	VX4OEE-840H-L2055	1085,00
per meter	4000K	On/Off	Low	3130lm/23,4W	2,6	VX4OWE-840E-L****	VX4OEE-840E-L****	569,00
per meter	4000K	On/Off	Medium	4300lm/32,3W	2,6	VX4OWE-840M-L****	VX4OEE-840M-L****	569,00
per meter	4000K	On/Off	High	5970lm/46,3W	2,6	VX4OWE-840H-L****	VX4OEE-840H-L****	569,00
per meter	4000K	DALI	Low	3130lm/23,4W	2,6	VX4OWL-840E-L****	VX4OEL-840E-L****	639,00
per meter	4000K	DALI	Medium	4300lm/32,3W	2,6	VX4OWL-840M-L****	VX4OEL-840M-L****	639,00
per meter	4000K	DALI	High	5970lm/46,3W	2,6	VX4OWL-840H-L****	VX4OEL-840H-L****	639,00

Wallwasher | Direct-Indirect

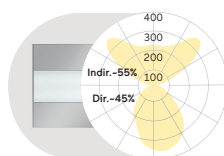

L mm	Colour Temperature	Control	Power	Lumen/Watt	Weight kg	Code Snow White	Code Silver Anodised	CHF
890	4000K	On/Off	Medium	3470lm/31W	2,4	VX4JWE-840M-L890	VX4JEE-840M-L890	700,00
890	4000K	On/Off	High	4810lm/43W	2,4	VX4JWE-840H-L890	VX4JEE-840H-L890	700,00
1182	4000K	On/Off	Medium	4630lm/40W	2,9	VX4JWE-840M-L1182	VX4JEE-840M-L1182	779,00
1182	4000K	On/Off	High	6420lm/56W	2,9	VX4JWE-840H-L1182	VX4JEE-840H-L1182	779,00
1475	4000K	On/Off	Medium	5790lm/48W	3,4	VX4JWE-840M-L1475	VX4JEE-840M-L1475	875,00
1475	4000K	On/Off	High	8020lm/69W	3,4	VX4JWE-840H-L1475	VX4JEE-840H-L1475	875,00
1765	4000K	On/Off	Medium	6940lm/57W	3,9	VX4JWE-840M-L1765	VX4JEE-840M-L1765	998,00
1765	4000K	On/Off	High	9620lm/82W	3,9	VX4JWE-840H-L1765	VX4JEE-840H-L1765	998,00
2055	4000K	On/Off	Medium	8100lm/71W	4,7	VX4JWE-840M-L2055	VX4JEE-840M-L2055	1155,00
2055	4000K	On/Off	High	11220lm/99W	4,7	VX4JWE-840H-L2055	VX4JEE-840H-L2055	1155,00
per meter	4000K	On/Off	Medium	3940lm/32,3W	2,6	VX4JWE-840M-L****	VX4JEE-840M-L****	578,00
per meter	4000K	On/Off	High	5460lm/46,3W	2,6	VX4JWE-840H-L****	VX4JEE-840H-L****	578,00
per meter	4000K	DALI	Medium	3940lm/32,3W	2,6	VX4JWL-840M-L****	VX4JEL-840M-L****	648,00
per meter	4000K	DALI	High	5460lm/46,3W	2,6	VX4JWL-840H-L****	VX4JEL-840H-L****	648,00

Lens Louvre | Direct

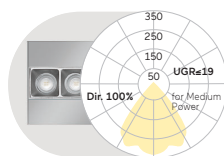

L mm	Colour Temperature	Control	Power	Lumen/Watt	Weight kg	Code Snow White/Jet Black	Code Silver Anodised/Jet Black	CHF
754	4000K	On/Off	Medium	1870lm/15W	2,6	VA4LWE-840M-L754-B*	VA4LEE-840M-L754-B*	543,00
754	4000K	On/Off	High	2690lm/22W	2,6	VA4LWE-840H-L754-B*	VA4LEE-840H-L754-B*	543,00
1004	4000K	On/Off	Medium	2500lm/19W	3,3	VA4LWE-840M-L1004-B*	VA4LEE-840M-L1004-B*	578,00
1004	4000K	On/Off	High	3590lm/28W	3,3	VA4LWE-840H-L1004-B*	VA4LEE-840H-L1004-B*	578,00
1254	4000K	On/Off	Medium	3120lm/23W	4,0	VA4LWE-840M-L1254-B*	VA4LEE-840M-L1254-B*	639,00
1254	4000K	On/Off	High	4500lm/34W	4,0	VA4LWE-840H-L1254-B*	VA4LEE-840H-L1254-B*	639,00
1504	4000K	On/Off	Medium	3750lm/27W	4,7	VA4LWE-840M-L1504-B*	VA4LEE-840M-L1504-B*	727,00
1504	4000K	On/Off	High	5380lm/40W	4,7	VA4LWE-840H-L1504-B*	VA4LEE-840H-L1504-B*	727,00
1754	4000K	On/Off	Medium	4370lm/31W	5,4	VA4LWE-840M-L1754-B*	VA4LEE-840M-L1754-B*	849,00
1754	4000K	On/Off	High	6280lm/46W	5,4	VA4LWE-840H-L1754-B*	VA4LEE-840H-L1754-B*	849,00
2004	4000K	On/Off	Medium	5000lm/35W	6,3	VA4LWE-840M-L2004-B*	VA4LEE-840M-L2004-B*	998,00
2004	4000K	On/Off	High	7180lm/53W	6,3	VA4LWE-840H-L2004-B*	VA4LEE-840H-L2004-B*	998,00
per meter	4000K	On/Off	Medium	2500lm/17,3W	3,3	VA4LWE-840M-L****-B*	VA4LEE-840M-L****-B*	490,00
per meter	4000K	On/Off	High	3600lm/26,4W	3,3	VA4LWE-840H-L****-B*	VA4LEE-840H-L****-B*	490,00
per meter	4000K	DALI	Medium	2500lm/17,3W	3,3	VA4LWL-840M-L****-B*	VA4LEL-840M-L****-B*	543,00
per meter	4000K	DALI	High	3600lm/26,4W	3,3	VA4LWL-840H-L****-B*	VA4LEL-840H-L****-B*	543,00

**** Your length in mm
 Meterpreise für Lichtsysteme nach Maß ab Mindestlänge 2200mm | Prices per metre for customised lighting systems with a minimum length of 2200mm
 Prix au mètre pour systèmes d'éclairage sur mesure à partir d'une longueur minimale de 2200mm

Microprismatic | Direct

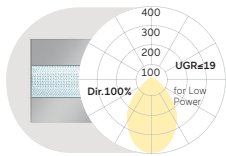

L mm	Colour Temperature	Control	Power	Lumen/Watt	Weight kg	Code Snow White	Code Silver Anodised	CHF
890	4000K	On/Off	Low	1230lm/12W	2,1	VA4AWE-840E-L890	VA4AEE-840E-L890	552,00
890	4000K	On/Off	Medium	1660lm/16W	2,1	VA4AWE-840M-L890	VA4AEE-840M-L890	552,00
890	4000K	On/Off	High	2350lm/23W	2,1	VA4AWE-840H-L890	VA4AEE-840H-L890	552,00
1182	4000K	On/Off	Low	1640lm/15W	2,6	VA4AWE-840E-L1182	VA4AEE-840E-L1182	595,00
1182	4000K	On/Off	Medium	2210lm/20W	2,6	VA4AWE-840M-L1182	VA4AEE-840M-L1182	595,00
1182	4000K	On/Off	High	3130lm/29W	2,6	VA4AWE-840H-L1182	VA4AEE-840H-L1182	595,00
1475	4000K	On/Off	Low	2050lm/18W	3,1	VA4AWE-840E-L1475	VA4AEE-840E-L1475	665,00
1475	4000K	On/Off	Medium	2770lm/25W	3,1	VA4AWE-840M-L1475	VA4AEE-840M-L1475	665,00
1475	4000K	On/Off	High	3920lm/36W	3,1	VA4AWE-840H-L1475	VA4AEE-840H-L1475	665,00
1765	4000K	On/Off	Low	2450lm/22W	3,6	VA4AWE-840E-L1765	VA4AEE-840E-L1765	770,00
1765	4000K	On/Off	Medium	3320lm/29W	3,6	VA4AWE-840M-L1765	VA4AEE-840M-L1765	770,00
1765	4000K	On/Off	High	4700lm/43W	3,6	VA4AWE-840H-L1765	VA4AEE-840H-L1765	770,00
2055	4000K	On/Off	Low	2860lm/27W	4,4	VA4AWE-840E-L2055	VA4AEE-840E-L2055	902,00
2055	4000K	On/Off	Medium	3870lm/36W	4,4	VA4AWE-840M-L2055	VA4AEE-840M-L2055	902,00
2055	4000K	On/Off	High	5490lm/52W	4,4	VA4AWE-840H-L2055	VA4AEE-840H-L2055	902,00
per meter	4000K	On/Off	Low	1390lm/12,3W	2,3	VA4AWE-840E-L****	VA4AEE-840E-L****	464,00
per meter	4000K	On/Off	Medium	1880lm/16,6W	2,3	VA4AWE-840M-L****	VA4AEE-840M-L****	464,00
per meter	4000K	On/Off	High	2670lm/24,2W	2,3	VA4AWE-840H-L****	VA4AEE-840H-L****	464,00
per meter	4000K	DALI	Low	1390lm/12,3W	2,3	VA4AWL-840E-L****	VA4AEL-840E-L****	517,00
per meter	4000K	DALI	Medium	1880lm/16,6W	2,3	VA4AWL-840M-L****	VA4AEL-840M-L****	517,00
per meter	4000K	DALI	High	2670lm/24,2W	2,3	VA4AWL-840H-L****	VA4AEL-840H-L****	517,00

Opal Diffuser | Direct

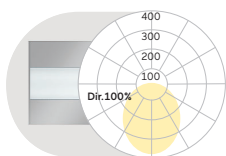

L mm	Colour Temperature	Control	Power	Lumen/Watt	Weight kg	Code Snow White	Code Silver Anodised	CHF
890	4000K	On/Off	Low	1350lm/12W	2,1	VA4OWE-840E-L890	VA4OEE-840E-L890	534,00
890	4000K	On/Off	Medium	1820lm/16W	2,1	VA4OWE-840M-L890	VA4OEE-840M-L890	534,00
890	4000K	On/Off	High	2580lm/23W	2,1	VA4OWE-840H-L890	VA4OEE-840H-L890	534,00
1182	4000K	On/Off	Low	1790lm/15W	2,6	VA4OWE-840E-L1182	VA4OEE-840E-L1182	560,00
1182	4000K	On/Off	Medium	2430lm/20W	2,6	VA4OWE-840M-L1182	VA4OEE-840M-L1182	560,00
1182	4000K	On/Off	High	3440lm/29W	2,6	VA4OWE-840H-L1182	VA4OEE-840H-L1182	560,00
1475	4000K	On/Off	Low	2240lm/18W	3,1	VA4OWE-840E-L1475	VA4OEE-840E-L1475	622,00
1475	4000K	On/Off	Medium	3030lm/25W	3,1	VA4OWE-840M-L1475	VA4OEE-840M-L1475	622,00
1475	4000K	On/Off	High	4300lm/36W	3,1	VA4OWE-840H-L1475	VA4OEE-840H-L1475	622,00
1765	4000K	On/Off	Low	2690lm/22W	3,6	VA4OWE-840E-L1765	VA4OEE-840E-L1765	718,00
1765	4000K	On/Off	Medium	3640lm/29W	3,6	VA4OWE-840M-L1765	VA4OEE-840M-L1765	718,00
1765	4000K	On/Off	High	5160lm/43W	3,6	VA4OWE-840H-L1765	VA4OEE-840H-L1765	718,00
2055	4000K	On/Off	Low	3140lm/27W	4,4	VA4OWE-840E-L2055	VA4OEE-840E-L2055	832,00
2055	4000K	On/Off	Medium	4250lm/36W	4,4	VA4OWE-840M-L2055	VA4OEE-840M-L2055	832,00
2055	4000K	On/Off	High	6020lm/52W	4,4	VA4OWE-840H-L2055	VA4OEE-840H-L2055	832,00
per meter	4000K	On/Off	Low	1530lm/12,3W	2,3	VA4OWE-840E-L****	VA4OEE-840E-L****	447,00
per meter	4000K	On/Off	Medium	2060lm/16,6W	2,3	VA4OWE-840M-L****	VA4OEE-840M-L****	447,00
per meter	4000K	On/Off	High	2930lm/24,2W	2,3	VA4OWE-840H-L****	VA4OEE-840H-L****	447,00
per meter	4000K	DALI	Low	1530lm/12,3W	2,3	VA4OWL-840E-L****	VA4OEL-840E-L****	499,00
per meter	4000K	DALI	Medium	2060lm/16,6W	2,3	VA4OWL-840M-L****	VA4OEL-840M-L****	499,00
per meter	4000K	DALI	High	2930lm/24,2W	2,3	VA4OWL-840H-L****	VA4OEL-840H-L****	499,00

Wallwasher | Direct

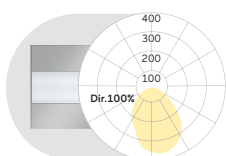

L mm	Colour Temperature	Control	Power	Lumen/Watt	Weight kg	Code Snow White	Code Silver Anodised	CHF
890	4000K	On/Off	Medium	1500lm/16W	2,1	VA4JWE-840M-L890	VA4JEE-840M-L890	552,00
890	4000K	On/Off	High	2130lm/23W	2,1	VA4JWE-840H-L890	VA4JEE-840H-L890	552,00
1182	4000K	On/Off	Medium	2000lm/20W	2,6	VA4JWE-840M-L1182	VA4JEE-840M-L1182	595,00
1182	4000K	On/Off	High	2840lm/29W	2,6	VA4JWE-840H-L1182	VA4JEE-840H-L1182	595,00
1475	4000K	On/Off	Medium	2500lm/25W	3,1	VA4JWE-840M-L1475	VA4JEE-840M-L1475	665,00
1475	4000K	On/Off	High	3550lm/36W	3,1	VA4JWE-840H-L1475	VA4JEE-840H-L1475	665,00
1765	4000K	On/Off	Medium	3000lm/29W	3,6	VA4JWE-840M-L1765	VA4JEE-840M-L1765	770,00
1765	4000K	On/Off	High	4250lm/43W	3,6	VA4JWE-840H-L1765	VA4JEE-840H-L1765	770,00
2055	4000K	On/Off	Medium	3500lm/36W	4,4	VA4JWE-840M-L2055	VA4JEE-840M-L2055	902,00
2055	4000K	On/Off	High	4960lm/52W	4,4	VA4JWE-840H-L2055	VA4JEE-840H-L2055	902,00
per meter	4000K	On/Off	Medium	1700lm/16,6W	2,3	VA4JWE-840M-L****	VA4JEE-840M-L****	455,00
per meter	4000K	On/Off	High	2410lm/24,2W	2,3	VA4JWE-840H-L****	VA4JEE-840H-L****	455,00
per meter	4000K	DALI	Medium	1700lm/16,6W	2,3	VA4JWL-840M-L****	VA4JEL-840M-L****	508,00
per meter	4000K	DALI	High	2410lm/24,2W	2,3	VA4JWL-840H-L****	VA4JEL-840H-L****	508,00

**** Your length in mm
 Meterpreise für Lichtsysteme nach Maß ab Mindestlänge 2200mm | Prices per metre for customised lighting systems with a minimum length of 2200mm
 Prix au mètre pour systèmes d'éclairage sur mesure à partir d'une longueur minimale de 2200mm

Surcharges

Optical System	CHF	Surface Finish	CHF	Control Gear	CHF	CHF	Colour Temperature	CHF	Lens Louvre*	CHF
O: Opal Diffuser	✓	W: Snow White	✓	E: On/Off	✓	L890-L1765	22: 2200K	+5%	W: Snow White	✓
D: Trucircle Polycarbonate Diffuser*	+5%	E: Silver Anodised	✓	L: DALI	+86,00	L2055	27: 2700K	+5%	A: Satin Silver	✓
		U: Urban Graphite	✓	H: Touch-Dim	+86,00		30: 3000K	✓	B: Jet Black	✓
		B: Jet Black	✓	C: Casambi*	+261,00		35: 3500K	+5%	H: Anodic Champagne	✓
		H: Anodic Champagne	+10%	6: DALI DT6 for TW	+172,00		40: 4000K	✓	K: Satin Copper	✓
		K: Satin Copper	+15%	8: DALI DT8 for TW	+172,00		65: 6500K	+5%	G: Satin Gold	✓
		R: Special RAL/NCS Colours	ⓘ				TW: Tunable White 2700-6500K**	+30%		
				*Only in combination with DALI. Please add to dimming price.					**Only in combination with DT6, DT8 or Casambi control. Please add additional control price.	
				Colour Rendering	CHF					
				8: CRI>80	✓					
				9: CRI>90	+5%					
				F: Full Spectrum	+15%					

Plank Y4/X4 | Surface

catalogue page 428

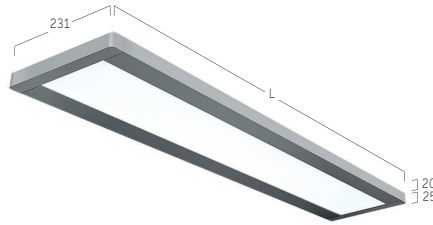

Microprismatic | Direct-Indirect

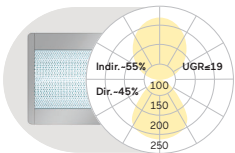

L mm	Colour Temperature	Control	Power	Lumen/Watt	Weight kg	Code Snow White	Code Silver Anodised	CHF
920	4000K	On/Off	Medium	2840lm/24W	5,8	JX4AWE-840M-L920	JX4AEE-840M-L920	674,00
920	4000K	On/Off	High	4530lm/38W	5,8	JX4AWE-840H-L920	JX4AEE-840H-L920	674,00
1210	4000K	On/Off	Medium	3790lm/33W	7,7	JX4AWE-840M-L1210	JX4AEE-840M-L1210	727,00
1210	4000K	On/Off	High	6030lm/53W	7,7	JX4AWE-840H-L1210	JX4AEE-840H-L1210	727,00
1500	4000K	On/Off	Medium	4740lm/40W	9,5	JX4AWE-840M-L1500	JX4AEE-840M-L1500	832,00
1500	4000K	On/Off	High	7540lm/64W	9,5	JX4AWE-840H-L1500	JX4AEE-840H-L1500	832,00
1800	4000K	On/Off	Medium	5690lm/47W	11,5	JX4AWE-840M-L1800	JX4AEE-840M-L1800	954,00
1800	4000K	On/Off	High	9050lm/76W	11,5	JX4AWE-840H-L1800	JX4AEE-840H-L1800	954,00

Opal Diffuser | Direct-Indirect

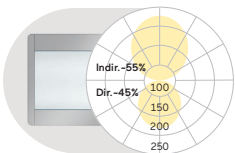

L mm	Colour Temperature	Control	Power	Lumen/Watt	Weight kg	Code Snow White	Code Silver Anodised	CHF
920	4000K	On/Off	Medium	2750lm/24W	5,8	JX4OWE-840M-L920	JX4OEE-840M-L920	657,00
920	4000K	On/Off	High	4380lm/38W	5,8	JX4OWE-840H-L920	JX4OEE-840H-L920	657,00
1210	4000K	On/Off	Medium	3670lm/33W	7,7	JX4OWE-840M-L1210	JX4OEE-840M-L1210	692,00
1210	4000K	On/Off	High	5830lm/53W	7,7	JX4OWE-840H-L1210	JX4OEE-840H-L1210	692,00
1500	4000K	On/Off	Medium	4580lm/40W	9,5	JX4OWE-840M-L1500	JX4OEE-840M-L1500	770,00
1500	4000K	On/Off	High	7290lm/64W	9,5	JX4OWE-840H-L1500	JX4OEE-840H-L1500	770,00
1800	4000K	On/Off	Medium	5500lm/47W	11,5	JX4OWE-840M-L1800	JX4OEE-840M-L1800	884,00
1800	4000K	On/Off	High	8750lm/76W	11,5	JX4OWE-840H-L1800	JX4OEE-840H-L1800	884,00

Microprismatic | Direct

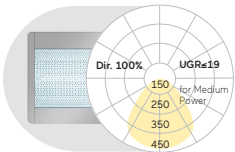

L mm	Colour Temperature	Control	Power	Lumen/Watt	Weight kg	Code Snow White	Code Silver Anodised	CHF
920	4000K	On/Off	Medium	1340lm/13W	5,5	JY4AWE-840M-L920	JY4AEE-840M-L920	613,00
920	4000K	On/Off	High	2130lm/21W	5,5	JY4AWE-840H-L920	JY4AEE-840H-L920	613,00
1210	4000K	On/Off	Medium	1790lm/17W	7,5	JY4AWE-840M-L1210	JY4AEE-840M-L1210	648,00
1210	4000K	On/Off	High	2840lm/27W	7,5	JY4AWE-840H-L1210	JY4AEE-840H-L1210	648,00
1500	4000K	On/Off	Medium	2240lm/20W	9,3	JY4AWE-840M-L1500	JY4AEE-840M-L1500	700,00
1500	4000K	On/Off	High	3550lm/33W	9,3	JY4AWE-840H-L1500	JY4AEE-840H-L1500	700,00
1800	4000K	On/Off	Medium	2690lm/24W	11,3	JY4AWE-840M-L1800	JY4AEE-840M-L1800	779,00
1800	4000K	On/Off	High	4260lm/39W	11,3	JY4AWE-840H-L1800	JY4AEE-840H-L1800	779,00

Opal Diffuser | Direct

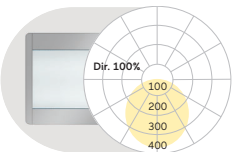

L mm	Colour Temperature	Control	Power	Lumen/Watt	Weight kg	Code Snow White	Code Silver Anodised	CHF
920	4000K	On/Off	Medium	1250lm/13W	5,5	JY4OWE-840M-L920	JY4OEE-840M-L920	595,00
920	4000K	On/Off	High	1980lm/21W	5,5	JY4OWE-840H-L920	JY4OEE-840H-L920	595,00
1210	4000K	On/Off	Medium	1670lm/17W	7,5	JY4OWE-840M-L1210	JY4OEE-840M-L1210	613,00
1210	4000K	On/Off	High	2640lm/27W	7,5	JY4OWE-840H-L1210	JY4OEE-840H-L1210	613,00
1500	4000K	On/Off	Medium	2080lm/20W	9,3	JY4OWE-840M-L1500	JY4OEE-840M-L1500	639,00
1500	4000K	On/Off	High	3300lm/33W	9,3	JY4OWE-840H-L1500	JY4OEE-840H-L1500	639,00
1800	4000K	On/Off	Medium	2500lm/24W	11,3	JY4OWE-840M-L1800	JY4OEE-840M-L1800	709,00
1800	4000K	On/Off	High	3960lm/39W	11,3	JY4OWE-840H-L1800	JY4OEE-840H-L1800	709,00

Surcharges

Surface

Surface	CHF
W: Snow White	✓
E: Silver Anodised	✓
U: Urban Graphite	✓
B: Jet Black	✓
H: Anodic Champagne	+10%
K: Satin Copper	+15%
R: Special RAL/NCS Colours	🔴

Control Gear

Control Gear	CHF	CHF
	L920-L1500	L1800
E: On/Off	✓	✓
H: Touch-Dim	+86,00	+172,00
L: DALI	+86,00	+172,00
6: DALI DT6 for TW	+172,00	+343,00
8: DALI DT8 for TW	+172,00	+343,00
C: Casambi*	+261,00	+261,00

*Only in combination with DALI. Please add to dimming price.

Colour Rendering

Colour Rendering	CHF
8: CRI>80	✓
9: CRI>90	+5%
F: Full Spectrum	+15%

Colour Temperature

Colour Temperature	CHF
22: 2200K	+5%
27: 2700K	+5%
30: 3000K	✓
35: 3500K	+5%
40: 4000K	✓
65: 6500K	+5%
TW: Tunable White 2700-6500K*	+30%

*Only in combination with DT6, DT8 or Casambi control. Please add additional control price.

✓ standard / no extra charge 🔴 on request ✗ not available



Midpin M2 |
Recessed
166



Midpoint E6 |
Semi-Recessed
166

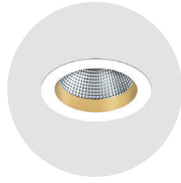

Midpoint F7 |
Recessed
166

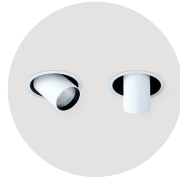

Midpoint M6 |
Recessed
167



Basic Superflat L7 |
Semi-Recessed
168



Basic Déco N3 |
Recessed Frameless
169



Basic Déco L3 |
Recessed Frame
170



Basic Max M2 |
Recessed Frameless
171



Basic Max M4 |
Recessed Frame
172



Basic Visio L9 |
Semi-Recessed
173



Ringo Star Compact F5 |
Recessed Frame
173

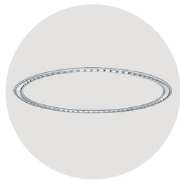

Ringo Star FX | System
40mm Recessed Frame
174

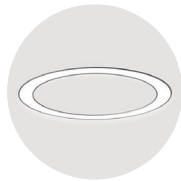

Ringo Star F1 | System
100mm Recessed Frame
175



Liquid Line Compact F5 |
Recessed Frame
176

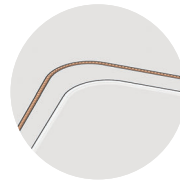

Liquid Line QX/FX |
System 40mm Recessed
177



Liquid Line F3 | System
60mm Recessed
179



Caleo Max M2 |
Recessed Frameless
180



Cubic Max M2 |
Recessed Frameless
181

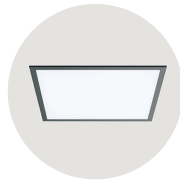

Cubic Max M4 |
Recessed Frame
181



Cubic Ambient M7 |
Recessed Frame
182



Cubic Déco L3 |
Recessed Frame
183

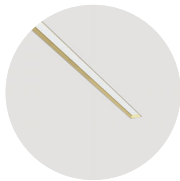

Matric Déco M9 |
Recessed Frameless
183

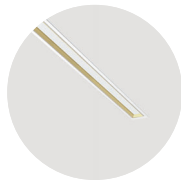

Matric Déco F9 |
Recessed Frame
185

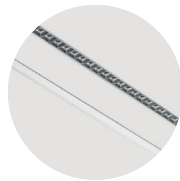

Matric MX | System 40mm
Recessed Frameless
186

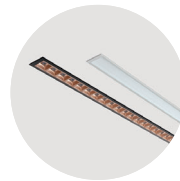

Matric FX | System
40mm Recessed Frame
188

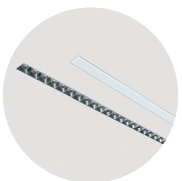

Matric M3 | System
55mm Recessed Frameless
189



Matric F3 | System
55mm Recessed Frame
191



Matric M5 | System 81mm
Recessed Frameless
193

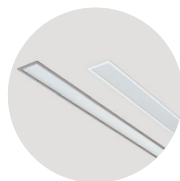

Matric F5 | System
81mm Recessed Frame
195

Einbau | Recessed | Encastré

Midpin M2 | Recessed

catalogue page 432

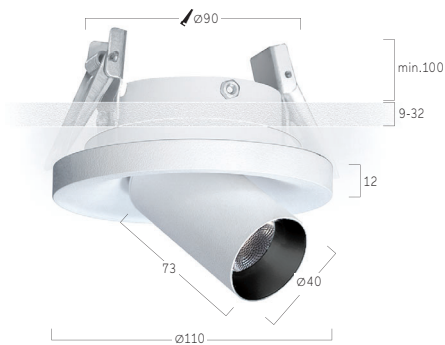

Led Engine - Eco:

Beam Angle	Colour Temperature	Control	Power	Lumen/Watt	Weight kg	Code Snow White	Code Jet Black	CHF
Medium 30°	4000K	On/Off	Medium	750lm/11W	0,8	DM2BWE-940M-W	DM2BBE-940M-B	315,00
Flood 40°	4000K	On/Off	Medium	770lm/11W	0,8	DM2CWE-940M-W	DM2CBE-940M-B	315,00



B Jet Black
W Snow White

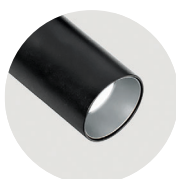

B Jet Black
A Satin Silver



B Jet Black
B Jet Black

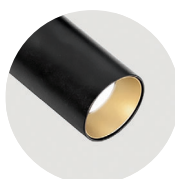

B Jet Black
G Satin Gold

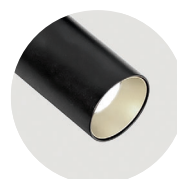

B Jet Black
H Anodic Champagne

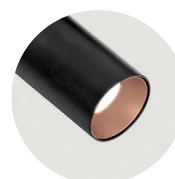

B Jet Black
K Satin Copper

Surcharges

Surface / Reflector Finish	CHF	Control Gear	CHF	Colour Temperature	CHF	Optic Ring	CHF
W: Snow White	✓	E: On/Off	✓	27: 2700K	+5%	W: Snow White	✓
B: Jet Black	✓	L: DALI	+86,00	30: 3000K	✓	V: Ivory White	✓
H: Anodic Champagne	+10%			35: 3500K	+5%	A: Satin Silver	✓
R: Special RAL/NCS Colours	ⓘ			40: 4000K	✓	B: Jet Black	✓
				DW: Dim to Warm 3000K-1800K*	+15%	H: Anodic Champagne	✓
						K: Satin Copper	✓
						G: Satin Gold	✓

✓ standard / no extra charge ⓘ on request ✗ not available

*Only in combination with DALI. Please add to dimming price.

Midpoint E6 | Semi-Recessed

catalogue page 436

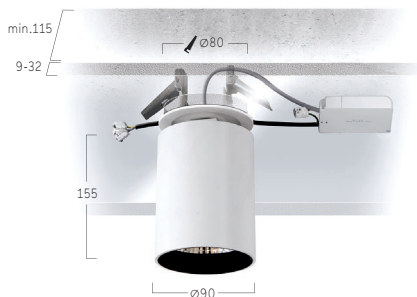

Led Engine - Eco:

Beam Angle	Colour Temperature	Control	Power	Lumen/Watt	Weight kg	Code Snow White	Code Radiant Silver	CHF
Spot 10°	4000K	On/Off	Low	1440lm/19W	1,5	PE6AWE-940FE-WK	PE6ASE-940FE-SK	387,00
Spot 10°	4000K	On/Off	Medium	2020lm/31W	1,5	PE6AWE-940FM-WK	PE6ASE-940FM-SK	387,00
Medium 20°	4000K	On/Off	Low	1850lm/19W	1,5	PE6BWE-940FE-WK	PE6BSE-940FE-SK	363,00
Medium 20°	4000K	On/Off	Medium	2870lm/31W	1,5	PE6BWE-940FM-WK	PE6BSE-940FM-SK	363,00
Flood 35°	4000K	On/Off	Low	1790lm/19W	1,5	PE6CWE-940FE-WK	PE6CSE-940FE-SK	363,00
Flood 35°	4000K	On/Off	Medium	2780lm/31W	1,5	PE6CWE-940FM-WK	PE6CSE-940FM-SK	363,00
W Flood 50°	4000K	On/Off	Low	1680lm/19W	1,5	PE6DWE-940FE-WK	PE6DSE-940FE-SK	363,00
W Flood 50°	4000K	On/Off	Medium	2710lm/31W	1,5	PE6DWE-940FM-WK	PE6DSE-940FM-SK	363,00

Led Engine - Artist Xicato:

Beam Angle	Colour Temperature	Control	Power	Lumen/Watt	Weight kg	Code Snow White	Code Radiant Silver	CHF
Spot 10°	4000K	On/Off	Low	1190lm/19W	1,5	PE6AWE-940AE-WK	PE6ASE-940AE-SK	501,00
Spot 10°	4000K	On/Off	Medium	1560lm/31W	1,5	PE6AWE-940AM-WK	PE6ASE-940AM-SK	501,00
Medium 20°	4000K	On/Off	Low	1510lm/19W	1,5	PE6BWE-940AE-WK	PE6BSE-940AE-SK	462,00
Medium 20°	4000K	On/Off	Medium	2220lm/31W	1,5	PE6BWE-940AM-WK	PE6BSE-940AM-SK	462,00
Flood 35°	4000K	On/Off	Low	1470lm/19W	1,5	PE6CWE-940AE-WK	PE6CSE-940AE-SK	462,00
Flood 35°	4000K	On/Off	Medium	2160lm/31W	1,5	PE6CWE-940AM-WK	PE6CSE-940AM-SK	462,00
W Flood 50°	4000K	On/Off	Low	1430lm/19W	1,5	PE6DWE-940AE-WK	PE6DSE-940AE-SK	462,00
W Flood 50°	4000K	On/Off	Medium	2140lm/31W	1,5	PE6DWE-940AM-WK	PE6DSE-940AM-SK	462,00



Optic Removal Tool for clear cover

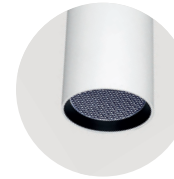

Honeycomb Louvre



Prismatic Lens

Surcharges

Surface	CHF	Control Gear	CHF	Cover	CHF	Optic Ring	CHF	Additional Options	CHF
W: Snow White	✓	E: On/Off	✓	K: Clear Cover	✓	W: Snow White	✓	Optic Removal Tool	34,00
V: Ivory White	✓	L: DALI	+86,00	P: Prismatic Lens	+21,00	V: Ivory White	✓		
S: Radiant Silver	✓	H: Touch-Dim	+86,00	H: Honeycomb Louvre	+21,00	S: Radiant Silver	✓		
B: Jet Black	✓	Colour Temperature	CHF			B: Jet Black	✓		
H: Anodic Champagne	+10%	27: 2700K	+5%			H: Anodic Champagne	✓		
R: Special RAL/NCS Colours	ⓘ	30: 3000K	✓			K: Satin Copper	✓		
		40: 4000K	✓			G: Satin Gold	✓		

✓ standard / no extra charge
ⓘ on request
✗ not available

Midpoint F7 | Recessed

catalogue page 438

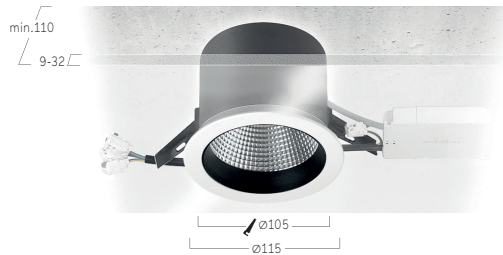
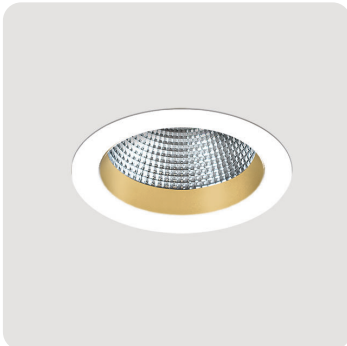

Led Engine - Eco:

Beam Angle	Colour Temperature	Control	Power	Lumen/Watt	Weight kg	Code Snow White	Code Radiant Silver	CHF
Spot 10°	4000K	On/Off	Low	1440lm/19W	1,2	PF7AWE-940FE-WK	PF7ASE-940FE-SK	368,00
Spot 10°	4000K	On/Off	Medium	2020lm/31W	1,2	PF7AWE-940FM-WK	PF7ASE-940FM-SK	368,00
Medium 20°	4000K	On/Off	Low	1850lm/19W	1,2	PF7BWE-940FE-WK	PF7BSE-940FE-SK	345,00
Medium 20°	4000K	On/Off	Medium	2870lm/31W	1,2	PF7BWE-940FM-WK	PF7BSE-940FM-SK	345,00
Flood 35°	4000K	On/Off	Low	1790lm/19W	1,2	PF7CWE-940FE-WK	PF7CSE-940FE-SK	345,00
Flood 35°	4000K	On/Off	Medium	2780lm/31W	1,2	PF7CWE-940FM-WK	PF7CSE-940FM-SK	345,00
W Flood 50°	4000K	On/Off	Low	1680lm/19W	1,2	PF7DWE-940FE-WK	PF7DSE-940FE-SK	345,00
W Flood 50°	4000K	On/Off	Medium	2710lm/31W	1,2	PF7DWE-940FM-WK	PF7DSE-940FM-SK	345,00

Led Engine - Artist Xicato:

Beam Angle	Colour Temperature	Control	Power	Lumen/Watt	Weight kg	Code Snow White	Code Radiant Silver	CHF
Spot 10°	4000K	On/Off	Low	1190lm/19W	1,2	PF7AWE-940AE-WK	PF7ASE-940AE-SK	455,00
Spot 10°	4000K	On/Off	Medium	1560lm/31W	1,2	PF7AWE-940AM-WK	PF7ASE-940AM-SK	455,00
Medium 20°	4000K	On/Off	Low	1510lm/19W	1,2	PF7BWE-940AE-WK	PF7BSE-940AE-SK	419,00
Medium 20°	4000K	On/Off	Medium	2220lm/31W	1,2	PF7BWE-940AM-WK	PF7BSE-940AM-SK	419,00
Flood 35°	4000K	On/Off	Low	1470lm/19W	1,2	PF7CWE-940AE-WK	PF7CSE-940AE-SK	419,00
Flood 35°	4000K	On/Off	Medium	2160lm/31W	1,2	PF7CWE-940AM-WK	PF7CSE-940AM-SK	419,00
W Flood 50°	4000K	On/Off	Low	1430lm/19W	1,2	PF7DWE-940AE-WK	PF7DSE-940AE-SK	419,00
W Flood 50°	4000K	On/Off	Medium	2140lm/31W	1,2	PF7DWE-940AM-WK	PF7DSE-940AM-SK	419,00



Optic Removal Tool for clear cover

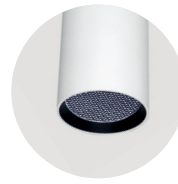

Honeycomb Louvre



Prismatic Lens

Surcharges

Surface	CHF	Control Gear	CHF	Cover	CHF	Optic Ring	CHF	Additional Options	CHF
W: Snow White	✓	E: On/Off	✓	K: Clear Cover	✓	W: Snow White	✓	Optic Removal Tool	34,00
V: Ivory White	✓	L: DALI	+86,00	P: Prismatic Lens	+21,00	V: Ivory White	✓		
S: Radiant Silver	✓	H: Touch-Dim	+86,00	H: Honeycomb Louvre	+21,00	S: Radiant Silver	✓		
B: Jet Black	✓	Colour Temperature	CHF			B: Jet Black	✓		
H: Anodic Champagne	+10%	27: 2700K	+5%			H: Anodic Champagne	✓		
R: Special RAL/NCS Colours	🔴	30: 3000K	✓			K: Satin Copper	✓		
		40: 4000K	✓			G: Satin Gold	✓		

✓ standard / no extra charge
🔴 on request
✗ not available

Midpoint Recessed | M6

catalogue page 440

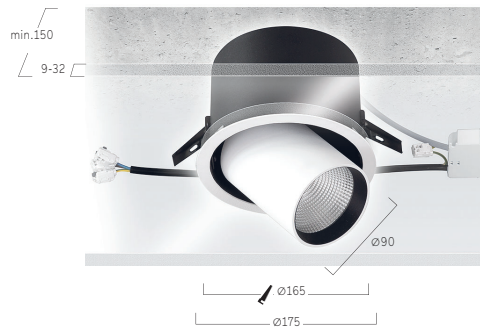
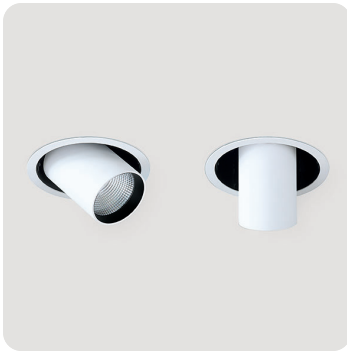

Led Engine - Eco:

Beam Angle	Colour Temperature	Control	Power	Lumen/Watt	Weight kg	Code Snow White	Code Radiant Silver	CHF
Spot 10°	4000K	On/Off	Low	1440lm/19W	2,0	PM6AWE-940FE-WK	PM6ASE-940FE-SK	394,00
Spot 10°	4000K	On/Off	Medium	2020lm/31W	2,0	PM6AWE-940FM-WK	PM6ASE-940FM-SK	394,00
Medium 20°	4000K	On/Off	Low	1850lm/19W	2,0	PM6BWE-940FE-WK	PM6BSE-940FE-SK	370,00
Medium 20°	4000K	On/Off	Medium	2870lm/31W	2,0	PM6BWE-940FM-WK	PM6BSE-940FM-SK	370,00
Flood 35°	4000K	On/Off	Low	1790lm/19W	2,0	PM6CWE-940FE-WK	PM6CSE-940FE-SK	370,00
Flood 35°	4000K	On/Off	Medium	2780lm/31W	2,0	PM6CWE-940FM-WK	PM6CSE-940FM-SK	370,00
W Flood 50°	4000K	On/Off	Low	1680lm/19W	2,0	PM6DWE-940FE-WK	PM6DSE-940FE-SK	370,00
W Flood 50°	4000K	On/Off	Medium	2710lm/31W	2,0	PM6DWE-940FM-WK	PM6DSE-940FM-SK	370,00

Led Engine - Artist Xicato:

Beam Angle	Colour Temperature	Control	Power	Lumen/Watt	Weight kg	Code Snow White	Code Radiant Silver	CHF
Spot 10°	4000K	On/Off	Low	1190lm/19W	2,0	PM6AWE-940AE-WK	PM6ASE-940AE-SK	482,00
Spot 10°	4000K	On/Off	Medium	1560lm/31W	2,0	PM6AWE-940AM-WK	PM6ASE-940AM-SK	482,00
Medium 20°	4000K	On/Off	Low	1510lm/19W	2,0	PM6BWE-940AE-WK	PM6BSE-940AE-SK	445,00
Medium 20°	4000K	On/Off	Medium	2220lm/31W	2,0	PM6BWE-940AM-WK	PM6BSE-940AM-SK	445,00
Flood 35°	4000K	On/Off	Low	1470lm/19W	2,0	PM6CWE-940AE-WK	PM6CSE-940AE-SK	445,00
Flood 35°	4000K	On/Off	Medium	2160lm/31W	2,0	PM6CWE-940AM-WK	PM6CSE-940AM-SK	445,00
W Flood 50°	4000K	On/Off	Low	1430lm/19W	2,0	PM6DWE-940AE-WK	PM6DSE-940AE-SK	445,00
W Flood 50°	4000K	On/Off	Medium	2140lm/31W	2,0	PM6DWE-940AM-WK	PM6DSE-940AM-SK	445,00

Surcharges

Surface	CHF	Control Gear	CHF	Cover	CHF	Optic Ring	CHF	Additional Options	CHF
W: Snow White	✓	E: On/Off	✓	K: Clear Cover	✓	W: Snow White	✓	Optic Removal Tool	34,00
V: Ivory White	✓	L: DALI	+86,00	P: Prismatic Lens	+21,00	V: Ivory White	✓		
S: Radiant Silver	✓	H: Touch-Dim	+86,00	H: Honeycomb Louvre	+21,00	S: Radiant Silver	✓		
B: Jet Black	✓	Colour Temperature	CHF			B: Jet Black	✓		
H: Anodic Champagne	+10%	27: 2700K	+5%			H: Anodic Champagne	✓		
R: Special RAL/NCS Colours	🔴	30: 3000K	✓			K: Satin Copper	✓		
		40: 4000K	✓			G: Satin Gold	✓		

✓ standard / no extra charge
🔴 on request
✗ not available

Basic L7 | Superflat Semi-Recessed

catalogue page 442



Cut-Out

D[mm]	300	400	500	600	800
D1[mm]	230	320	410	490	670



Microprismatic | Direct

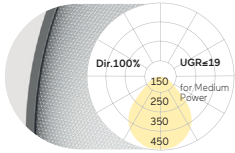

D mm	Colour Temperature	Control	Power	Lumen/Watt	Weight kg	Code Snow White	Code Radiant Silver	CHF
300	4000K	On/Off	Medium	690lm/7W	1,9	BL7AWE-840M-D300	BL7ASE-840M-D300	699,00
300	4000K	On/Off	High	1190lm/11W	1,9	BL7AWE-840H-D300	BL7ASE-840H-D300	699,00
400	4000K	On/Off	Medium	1470lm/12W	3,1	BL7AWE-840M-D400	BL7ASE-840M-D400	945,00
400	4000K	On/Off	High	2560lm/21W	3,1	BL7AWE-840H-D400	BL7ASE-840H-D400	945,00
500	4000K	On/Off	Medium	2030lm/16W	4,5	BL7AWE-840M-D500	BL7ASE-840M-D500	1154,00
500	4000K	On/Off	High	3570lm/28W	4,5	BL7AWE-840H-D500	BL7ASE-840H-D500	1154,00
600	4000K	On/Off	Medium	3390lm/25W	6,0	BL7AWE-840M-D600	BL7ASE-840M-D600	1493,00
600	4000K	On/Off	High	5520lm/42W	6,0	BL7AWE-840H-D600	BL7ASE-840H-D600	1493,00
800	4000K	On/Off	Medium	5160lm/40W	9,0	BL7AWE-840M-D800	BL7ASE-840M-D800	2687,00
800	4000K	On/Off	High	6980lm/54W	9,0	BL7AWE-840H-D800	BL7ASE-840H-D800	2687,00

Opal Diffuser | Direct

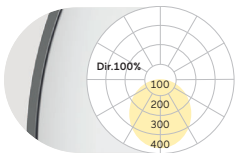

D mm	Colour Temperature	Control	Power	Lumen/Watt	Weight kg	Code Snow White	Code Radiant Silver	CHF
300	4000K	On/Off	Medium	700lm/7W	1,9	BL7OWE-840M-D300	BL7OSE-840M-D300	660,00
300	4000K	On/Off	High	1200lm/11W	1,9	BL7OWE-840H-D300	BL7OSE-840H-D300	660,00
400	4000K	On/Off	Medium	1490lm/12W	3,1	BL7OWE-840M-D400	BL7OSE-840M-D400	888,00
400	4000K	On/Off	High	2580lm/21W	3,1	BL7OWE-840H-D400	BL7OSE-840H-D400	888,00
500	4000K	On/Off	Medium	2070lm/16W	4,5	BL7OWE-840M-D500	BL7OSE-840M-D500	1098,00
500	4000K	On/Off	High	3630lm/28W	4,5	BL7OWE-840H-D500	BL7OSE-840H-D500	1098,00
600	4000K	On/Off	Medium	3460lm/25W	6,0	BL7OWE-840M-D600	BL7OSE-840M-D600	1418,00
600	4000K	On/Off	High	5620lm/42W	6,0	BL7OWE-840H-D600	BL7OSE-840H-D600	1418,00
800	4000K	On/Off	Medium	5280lm/40W	9,0	BL7OWE-840M-D800	BL7OSE-840M-D800	2611,00
800	4000K	On/Off	High	7150lm/54W	9,0	BL7OWE-840H-D800	BL7OSE-840H-D800	2611,00

Surcharges

Surface Finish	CHF	Control Gear	CHF	CHF	Colour Rendering	CHF	Colour Temperature	CHF	Additional Options	CHF
W: Snow White	✓	E: On/Off	✓	✓	8: CRI>80	✓	22: 2200K	+5%	Radar Sensor	+209,00
V: Ivory White	✓	L: DALI	+86,00	+172,00	9: CRI>90	+5%	27: 2700K	+5%	Multisensor [D400-D800]	+261,00
S: Radiant Silver	✓	H: Touch-Dim	+86,00	+172,00	F: Full Spectrum	+15%	30: 3000K	✓	Emergency Module [DALI, Autotest, incl. 3H Battery] [D400-D800]	+366,00
U: Urban Graphite	✓	C: Casambi*	+261,00	+261,00			35: 3500K	+5%		
B: Jet Black	✓	6: DALI DT6 for TW	+172,00	+343,00			40: 4000K	✓		
H: Anodic Champagne	+10%	8: DALI DT8 for TW	+172,00	+343,00			65: 6500K	+5%		
K: Satin Copper	+15%						TW: Tunable White 2700-6500K* [D400-D800]	+30%		
R: Special RAL/NCS Colours	ⓘ									

✓ standard / no extra charge ⓘ on request ✗ not available

*Only in combination with DT6, DT8 or Casambi control. Please add additional control price.

Basic Déco N3 | Recessed Frameless

catalogue page 444

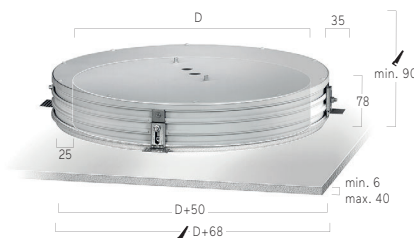

... Basic Déco N3 | Recessed Frameless

Microprismatic | Direct with Indirect Light Corona

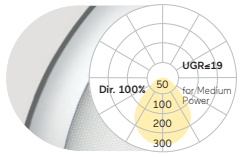

D mm	Colour Temperature	Control	Power	Lumen/Watt	Weight kg	Code Snow White	Code Radiant Silver	CHF
300	4000K	On/Off	Medium	990lm/14W	3,6	BN3AWE-840M-D300-WW	BN3ASE-840M-D300-SW	891,00
300	4000K	On/Off	High	1720lm/23W	3,6	BN3AWE-840H-D300-WW	BN3ASE-840H-D300-SW	891,00
400	4000K	On/Off	Medium	1830lm/24W	5,7	BN3AWE-840M-D400-WW	BN3ASE-840M-D400-SW	1112,00
400	4000K	On/Off	High	2920lm/37W	5,7	BN3AWE-840H-D400-WW	BN3ASE-840H-D400-SW	1112,00
500	4000K	On/Off	Medium	2800lm/36W	7,9	BN3AWE-840M-D500-WW	BN3ASE-840M-D500-SW	1339,00
500	4000K	On/Off	High	4620lm/41W	7,9	BN3AWE-840H-D500-WW	BN3ASE-840H-D500-SW	1339,00
600	4000K	On/Off	Medium	4020lm/44W	10,4	BN3AWE-840M-D600-WW	BN3ASE-840M-D600-SW	1698,00
600	4000K	On/Off	High	5910lm/65W	10,4	BN3AWE-840H-D600-WW	BN3ASE-840H-D600-SW	1698,00

Opal Diffuser | Direct with Indirect Light Corona

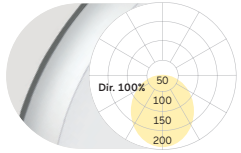

D mm	Colour Temperature	Control	Power	Lumen/Watt	Weight kg	Code Snow White	Code Radiant Silver	CHF
300	4000K	On/Off	Medium	970lm/14W	3,6	BN3OWE-840M-D300-WW	BN3OSE-840M-D300-SW	856,00
300	4000K	On/Off	High	1690lm/23W	3,6	BN3OWE-840H-D300-WW	BN3OSE-840H-D300-SW	856,00
400	4000K	On/Off	Medium	1830lm/24W	5,7	BN3OWE-840M-D400-WW	BN3OSE-840M-D400-SW	1059,00
400	4000K	On/Off	High	2920lm/37W	5,7	BN3OWE-840H-D400-WW	BN3OSE-840H-D400-SW	1059,00
500	4000K	On/Off	Medium	2820lm/36W	7,9	BN3OWE-840M-D500-WW	BN3OSE-840M-D500-SW	1269,00
500	4000K	On/Off	High	4670lm/41W	7,9	BN3OWE-840H-D500-WW	BN3OSE-840H-D500-SW	1269,00
600	4000K	On/Off	Medium	4110lm/44W	10,4	BN3OWE-840M-D600-WW	BN3OSE-840M-D600-SW	1549,00
600	4000K	On/Off	High	6010lm/65W	10,4	BN3OWE-840H-D600-WW	BN3OSE-840H-D600-SW	1549,00

Surcharges

Surface / Reflector Finish

Uni-Colours

Code	Finish	CHF
W...W:	Snow White / Snow White	✓
V...V:	Ivory White / Ivory White	✓
S...S:	Radiant Silver / Radiant Silver	✓
U...U:	Urban Graphite / Urban Graphite	✓
B...B:	Jet Black / Jet Black	✓
H...H:	Anodic Champ. / Anodic Champ.	+10%
K...K:	Satin Copper / Satin Copper	+15%

Housing for frameless installation is always white.

✓ standard / no extra charge ⚠ on request ✗ not available

Surface / Reflector Finish

Dual Colours

Code	Finish	CHF
W...G:	Snow White / Satin Gold	+15%
W...K:	Snow White / Satin Copper	+15%
W...B:	Snow White / Jet Black	+15%
H...B:	Anodic Champagne / Jet Black	+15%
B...G:	Jet Black / Satin Gold	+15%
B...W:	Jet Black / Snow White	+15%

Control Gear

Code	Control Gear	CHF
E:	On/Off	✓
L:	DALI	+86,00
H:	Touch-Dim	+86,00
C:	Casambi*	+261,00

*Only in combination with DALI. Please add to dimming price.

Colour Rendering

Code	Colour Rendering	CHF
8:	CRI>80	✓
9:	CRI>90	+5%
F:	Full Spectrum	+15%

Colour Temperature

Code	Colour Temperature	CHF
22:	2200K	+5%
27:	2700K	+5%
30:	3000K	✓
35:	3500K	+5%
40:	4000K	✓
65:	6500K	+5%

Aura Colour

Code	Aura Colour	CHF
R:	Red	✓
B:	Blue	✓
M:	Magenta	✓
W:	White	✓

Basic Déco L3 | Recessed Frame

catalogue page 446

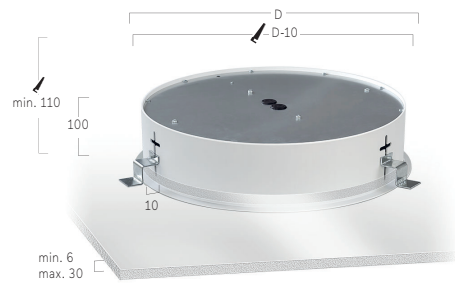

Microprismatic | Direct

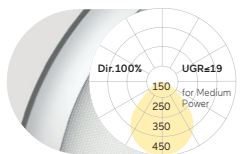

D mm	Colour Temperature	Control	Power	Lumen/Watt	Weight kg	Code Snow White	Code Radiant Silver	CHF
330	4000K	On/Off	Low	880lm/8W	3,1	BL3AWE-840E-D330-W	BL3ASE-840E-D330-S	751,00
330	4000K	On/Off	Medium	1730lm/14W	3,1	BL3AWE-840M-D330-W	BL3ASE-840M-D330-S	751,00
430	4000K	On/Off	Low	1740lm/13W	4,6	BL3AWE-840E-D430-W	BL3ASE-840E-D430-S	954,00
430	4000K	On/Off	Medium	3580lm/29W	4,6	BL3AWE-840M-D430-W	BL3ASE-840M-D430-S	954,00
530	4000K	On/Off	Low	2480lm/18W	7,1	BL3AWE-840E-D530-W	BL3ASE-840E-D530-S	1164,00
530	4000K	On/Off	Medium	4860lm/35W	7,1	BL3AWE-840M-D530-W	BL3ASE-840M-D530-S	1164,00
680	4000K	On/Off	Low	3860lm/28W	10,5	BL3AWE-840E-D680-W	BL3ASE-840E-D680-S	1505,00
680	4000K	On/Off	Medium	7250lm/52W	10,5	BL3AWE-840M-D680-W	BL3ASE-840M-D680-S	1505,00

Opal Diffuser | Direct

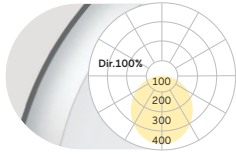

D mm	Colour Temperature	Control	Power	Lumen/Watt	Weight kg	Code Snow White	Code Radiant Silver	CHF
330	4000K	On/Off	Low	910lm/8W	3,1	BL3OWE-840E-D330-W	BL3OSE-840E-D330-S	716,00
330	4000K	On/Off	Medium	1780lm/14W	3,1	BL3OWE-840M-D330-W	BL3OSE-840M-D330-S	716,00
430	4000K	On/Off	Low	1790lm/13W	4,6	BL3OWE-840E-D430-W	BL3OSE-840E-D430-S	902,00
430	4000K	On/Off	Medium	3690lm/29W	4,6	BL3OWE-840M-D430-W	BL3OSE-840M-D430-S	902,00
530	4000K	On/Off	Low	2550lm/18W	7,1	BL3OWE-840E-D530-W	BL3OSE-840E-D530-S	1094,00
530	4000K	On/Off	Medium	5010lm/35W	7,1	BL3OWE-840M-D530-W	BL3OSE-840M-D530-S	1094,00
680	4000K	On/Off	Low	3980lm/28W	10,5	BL3OWE-840E-D680-W	BL3OSE-840E-D680-S	1357,00
680	4000K	On/Off	Medium	7470lm/52W	10,5	BL3OWE-840M-D680-W	BL3OSE-840M-D680-S	1357,00
990	4000K	On/Off	Low	7000lm/59W	15,4	BL3OWE-840E-D990-W	BL3OSE-840E-D990-S	2589,00
990	4000K	On/Off	Medium	11830lm/106W	15,4	BL3OWE-840M-D990-W	BL3OSE-840M-D990-S	2589,00

Surcharges

Surface / Reflector Finish

Uni-Colours

Surface / Reflector Finish	CHF
W...W: Snow White / Snow White	✓
V...V: Ivory White / Ivory White	✓
S...S: Radiant Silver / Radiant Silver	✓
U...U: Urban Graphite / Urban Graphite	✓
B...B: Jet Black / Jet Black	✓
H...H: Anodic Champ. / Anodic Champ.	+10%
K...K: Satin Copper / Satin Copper	+15%

Surface / Reflector Finish

Dual Colours

Surface / Reflector Finish	CHF
W...G: Snow White / Satin Gold	+15%
W...K: Snow White / Satin Copper	+15%
W...B: Snow White / Jet Black	+15%
H...B: Anodic Champagne / Jet Black	+15%
B...G: Jet Black / Satin Gold	+15%
B...W: Jet Black / Snow White	+15%

Control Gear	CHF	CHF
D330-D680		D990
E: On/Off	✓	✓
H: Touch-Dim	+86,00	+172,00
L: DALI	+86,00	+172,00
G: DALI DT6 for TW	+172,00	+343,00
8: DALI DT8 for TW	+172,00	+343,00
C: Casambi*	+261,00	+261,00

*Only in combination with DALI. Please add to dimming price.

Colour Rendering

Colour Rendering	CHF
8: CRI>80	✓
9: CRI>90	+5%
F: Full Spectrum	+15%

Colour Temperature

Colour Temperature	CHF
22: 2200K	+5%
27: 2700K	+5%
30: 3000K	✓
35: 3500K	+5%
40: 4000K	✓
65: 6500K	+5%
TW: Tunable White 2700-6500K* [D430-D990]	+30%

*Only in combination with DT6, DT8 or Casambi control. Please add additional control price.

Additional Options

Additional Options	CHF
Radar Sensor	+209,00
Emergency Module [DALI, Autotest, incl. 3H Battery]	+366,00

✓ standard / no extra charge ⚡ on request ✗ not available

Basic Max M2 | Recessed Frameless

catalogue page 450

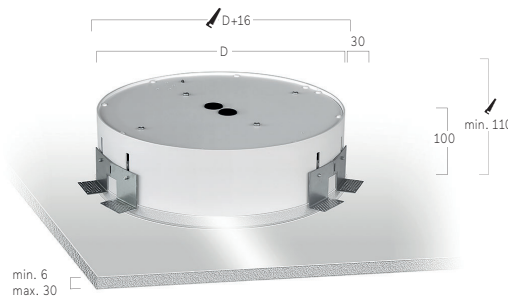

Installation Template
Please order separately

Type	Code	CHF
WT for Basic-M2/Ø300	BM2-WT-300	28,00
WT for Basic-M2/Ø400	BM2-WT-400	32,00
WT for Basic-M2/Ø500	BM2-WT-500	35,00
WT for Basic-M2/Ø650	BM2-WT-650	44,00
WT for Basic-M2/Ø950	BM2-WT-950	53,00



Microprismatic | Direct

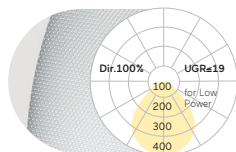

D mm	Colour Temperature	Control	Power	Lumen/Watt	Weight kg	Code Snow White	CHF
300	4000K	On/Off	Low	880lm/8W	2,0	BM2AWE-840E-D300	587,00
300	4000K	On/Off	Medium	1730lm/14W	2,0	BM2AWE-840M-D300	587,00
400	4000K	On/Off	Low	1740lm/13W	3,6	BM2AWE-840E-D400	734,00
400	4000K	On/Off	Medium	3580lm/29W	3,6	BM2AWE-840M-D400	734,00
500	4000K	On/Off	Low	2480lm/18W	5,9	BM2AWE-840E-D500	954,00
500	4000K	On/Off	Medium	4860lm/35W	5,9	BM2AWE-840M-D500	954,00
650	4000K	On/Off	Low	3860lm/28W	10,6	BM2AWE-840E-D650	1287,00
650	4000K	On/Off	Medium	7250lm/52W	10,6	BM2AWE-840M-D650	1287,00

Opal Diffuser | Direct

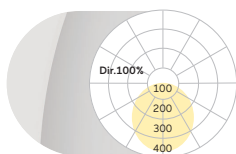

D mm	Colour Temperature	Control	Power	Lumen/Watt	Weight kg	Code Snow White	CHF
300	4000K	On/Off	Low	910lm/8W	2,0	BM2OWE-840E-D300	541,00
300	4000K	On/Off	Medium	1780lm/14W	2,0	BM2OWE-840M-D300	541,00
400	4000K	On/Off	Low	1790lm/13W	3,6	BM2OWE-840E-D400	639,00
400	4000K	On/Off	Medium	3690lm/29W	3,6	BM2OWE-840M-D400	639,00
500	4000K	On/Off	Low	2550lm/18W	5,9	BM2OWE-840E-D500	823,00
500	4000K	On/Off	Medium	5010lm/35W	5,9	BM2OWE-840M-D500	823,00
650	4000K	On/Off	Low	3980lm/28W	10,6	BM2OWE-840E-D650	1112,00
650	4000K	On/Off	Medium	7470lm/52W	10,6	BM2OWE-840M-D650	1112,00
950	4000K	On/Off	Low	7000lm/59W	18,7	BM2OWE-840E-D950	2267,00
950	4000K	On/Off	Medium	11830lm/106W	18,7	BM2OWE-840M-D950	2267,00

Surcharges		Colour Rendering		Colour Temperature		Additional Options		
Control Gear	CHF	CHF	CHF	CHF	CHF	CHF	CHF	
E: On/Off	✓	D300-D650	8: CRI>80	✓	22: 2200K	+5%	Radar Sensor	+209,00
L: DALI	+86,00	D950	9: CRI>90	+5%	27: 2700K	+5%	Emergency Module [DALI, Autotest, incl. 3H Battery]	+366,00
H: Touch-Dim	+86,00		F: Full Spectrum	+15%	30: 3000K	✓		
C: Casambi*	+261,00				35: 3500K	+5%		
6: DALI DT6 for TW	+172,00				40: 4000K	✓		
8: DALI DT8 for TW	+172,00				65: 6500K	+5%		
					TW: Tunable White 2700-6500K*	+30%		

*Only in combination with DALI. Please add to dimming price.

*Only in combination with DT6, DT8 or Casambi control. Please add additional control price.

✓ standard / no extra charge ⚡ on request ✗ not available

Basic Max M4 | Recessed Frame

catalogue page 452

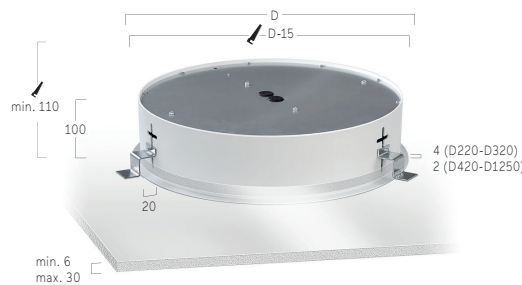

Microprismatic | Direct

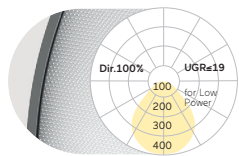

D mm	Colour Temperature	Control	Power	Lumen/Watt	Weight kg	Code Snow White	Code Radiant Silver	CHF
220	4000K	On/Off	Low	450lm/5W	1,7	BM4AWE-840E-D220	BM4ASE-840E-D220	482,00
220	4000K	On/Off	Medium	1110lm/10W	1,7	BM4AWE-840M-D220	BM4ASE-840M-D220	482,00
320	4000K	On/Off	Low	880lm/8W	3,1	BM4AWE-840E-D320	BM4ASE-840E-D320	578,00
320	4000K	On/Off	Medium	1730lm/14W	3,1	BM4AWE-840M-D320	BM4ASE-840M-D320	578,00
420	4000K	On/Off	Low	1740lm/13W	3,2	BM4AWE-840E-D420	BM4ASE-840E-D420	699,00
420	4000K	On/Off	Medium	3580lm/29W	3,2	BM4AWE-840M-D420	BM4ASE-840M-D420	699,00
520	4000K	On/Off	Low	2480lm/18W	5,5	BM4AWE-840E-D520	BM4ASE-840E-D520	926,00
520	4000K	On/Off	Medium	4860lm/35W	5,5	BM4AWE-840M-D520	BM4ASE-840M-D520	926,00
670	4000K	On/Off	Low	3860lm/28W	10,2	BM4AWE-840E-D670	BM4ASE-840E-D670	1241,00
670	4000K	On/Off	Medium	7250lm/52W	10,2	BM4AWE-840M-D670	BM4ASE-840M-D670	1241,00

Opal Diffuser | Direct

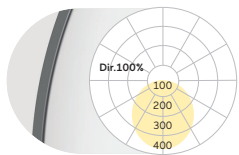

D mm	Colour Temperature	Control	Power	Lumen/Watt	Weight kg	Code Snow White	Code Radiant Silver	CHF
220	4000K	On/Off	Low	470lm/5W	1,7	BM4OWE-840E-D220	BM4OSE-840E-D220	455,00
220	4000K	On/Off	Medium	1160lm/10W	1,7	BM4OWE-840M-D220	BM4OSE-840M-D220	455,00
320	4000K	On/Off	Low	910lm/8W	3,1	BM4OWE-840E-D320	BM4OSE-840E-D320	524,00
320	4000K	On/Off	Medium	1780lm/14W	3,1	BM4OWE-840M-D320	BM4OSE-840M-D320	524,00
420	4000K	On/Off	Low	1790lm/13W	3,2	BM4OWE-840E-D420	BM4OSE-840E-D420	611,00
420	4000K	On/Off	Medium	3690lm/29W	3,2	BM4OWE-840M-D420	BM4OSE-840M-D420	611,00
520	4000K	On/Off	Low	2550lm/18W	5,5	BM4OWE-840E-D520	BM4OSE-840E-D520	786,00
520	4000K	On/Off	Medium	5010lm/35W	5,5	BM4OWE-840M-D520	BM4OSE-840M-D520	786,00
670	4000K	On/Off	Low	3980lm/28W	10,2	BM4OWE-840E-D670	BM4OSE-840E-D670	1066,00
670	4000K	On/Off	Medium	7470lm/52W	10,2	BM4OWE-840M-D670	BM4OSE-840M-D670	1066,00
980	4000K	On/Off	Low	7000lm/59W	20,0	BM4OWE-840E-D980	BM4OSE-840E-D980	2151,00
980	4000K	On/Off	Medium	11830lm/106W	20,0	BM4OWE-840M-D980	BM4OSE-840M-D980	2151,00
1250	4000K	On/Off	Low	12250lm/107W	27,0	BM4OWE-840E-D1250	BM4OSE-840E-D1250	3486,00
1250	4000K	On/Off	Medium	20700lm/195W	27,0	BM4OWE-840M-D1250	BM4OSE-840M-D1250	3486,00

Surcharges		Control Gear		Colour Rendering		Colour Temperature		Additional Options	
Surface Finish	CHF	CHF	CHF	CHF	CHF	CHF	CHF	CHF	CHF
W: Snow White	✓	D220-D670	8: CRI>80	✓	22: 2200K	+5%	Radar Sensor	+209,00	
V: Ivory White	✓	D980-D1250	9: CRI>90	+5%	27: 2700K	+5%	Emergency Module [DALI, Autotest, incl. 3H Battery]	+366,00	
S: Radiant Silver	✓		F: Full Spectrum	+15%	30: 3000K	✓			
U: Urban Graphite	✓				35: 3500K	+5%			
B: Jet Black	✓				40: 4000K	✓			
H: Anodic Champagne	+10%				65: 6500K	+5%			
K: Satin Copper	+15%				TW: Tunable White 2700-6500K** [D320-D1250]	+30%			
R: Special RAL/NCS Colours	⚡								

*Only in combination with DALI. Please add to dimming price.

**Only in combination with DT6, DT8 or Casambi control. Please add additional control price.

✓ standard / no extra charge ⚡ on request ✗ not available

Basic Visio L9 | Semi-Recessed

catalogue page 454

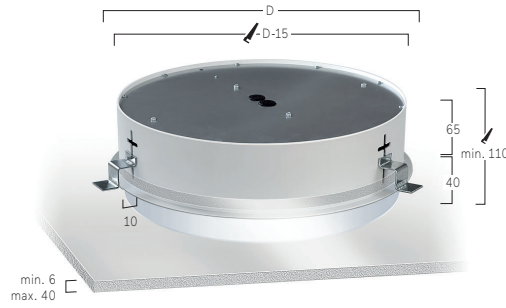

Microprismatic | Direct

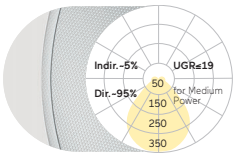

D mm	Colour Temperature	Control	Power	Lumen/Watt	Weight kg	Code Snow White	Code Radiant Silver	CHF
325	4000K	On/Off	Medium	630lm/5W	4,5	BL9AWE-840M-D325	BL9ASE-840M-D325	839,00
325	4000K	On/Off	High	1000lm/9W	4,5	BL9AWE-840H-D325	BL9ASE-840H-D325	839,00
425	4000K	On/Off	Medium	1630lm/13W	6,2	BL9AWE-840M-D425	BL9ASE-840M-D425	1066,00
425	4000K	On/Off	High	2840lm/22W	6,2	BL9AWE-840H-D425	BL9ASE-840H-D425	1066,00
525	4000K	On/Off	Medium	2470lm/19W	8,0	BL9AWE-840M-D525	BL9ASE-840M-D525	1346,00
525	4000K	On/Off	High	4560lm/34W	8,0	BL9AWE-840H-D525	BL9ASE-840H-D525	1346,00
635	4000K	On/Off	Medium	3340lm/25W	9,8	BL9AWE-840M-D635	BL9ASE-840M-D635	1819,00
635	4000K	On/Off	High	6200lm/46W	9,8	BL9AWE-840H-D635	BL9ASE-840H-D635	1819,00

Opal Diffuser | Direct

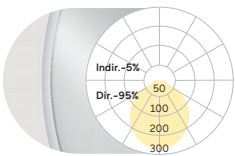

D mm	Colour Temperature	Control	Power	Lumen/Watt	Weight kg	Code Snow White	Code Radiant Silver	CHF
325	4000K	On/Off	Medium	670lm/5W	4,5	BL9OWE-840M-D325	BL9OSE-840M-D325	751,00
325	4000K	On/Off	High	1060lm/9W	4,5	BL9OWE-840H-D325	BL9OSE-840H-D325	751,00
425	4000K	On/Off	Medium	1730lm/13W	6,2	BL9OWE-840M-D425	BL9OSE-840M-D425	961,00
425	4000K	On/Off	High	3020lm/22W	6,2	BL9OWE-840H-D425	BL9OSE-840H-D425	961,00
525	4000K	On/Off	Medium	2620lm/19W	8,0	BL9OWE-840M-D525	BL9OSE-840M-D525	1206,00
525	4000K	On/Off	High	4830lm/34W	8,0	BL9OWE-840H-D525	BL9OSE-840H-D525	1206,00
635	4000K	On/Off	Medium	3550lm/25W	9,8	BL9OWE-840M-D635	BL9OSE-840M-D635	1556,00
635	4000K	On/Off	High	6570lm/46W	9,8	BL9OWE-840H-D635	BL9OSE-840H-D635	1556,00

Surcharges

Surface Finish	CHF	Control Gear	CHF	Colour Rendering	CHF	Colour Temperature	CHF	Additional Options	CHF
W: Snow White	✓	E: On/Off	✓	8: CRI>80	✓	22: 2200K	+5%	Emergency Module [DALI, Autotest, incl. 3H Battery] [D425-D635]	+366,00
V: Ivory White	✓	L: DALI	+86,00	9: CRI>90	+5%	27: 2700K	+5%		
S: Radiant Silver	✓	H: Touch-Dim	+86,00	F: Full Spectrum	+15%	30: 3000K	✓		
U: Urban Graphite	✓	C: Casambi*	+261,00			35: 3500K	+5%		
B: Jet Black	✓	6: DALI DT6 for TW	+172,00			40: 4000K	✓		
H: Anodic Champagne	+10%	8: DALI DT8 for TW	+172,00			65: 6500K	+5%		
K: Satin Copper	+15%					TW: Tunable White 2700-6500K** [D425-D635]	+30%		
R: Special RAL/NCS Colours	🚫								

✓ standard / no extra charge 🚫 on request ✗ not available

**Only in combination with DT6, DT8 or Casambi control. Please add additional control price.

Ringo Star F5 | Compact Recessed Frame

catalogue page 456

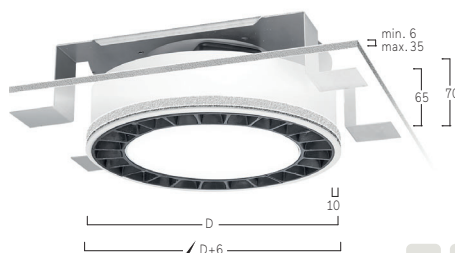

... Ringo Star F5 | Compact Recessed Frame

Lens Louvre | Direct

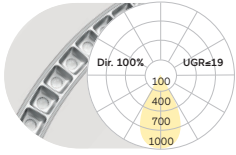

D mm	Colour Temperature	Control	Power	Lumen/Watt	Weight kg	Code Snow White/Jet Black	Code Jet Black/Jet Black	CHF
200	4000K	On/Off	Low	1570lm/13W	2,8	RF5LWE-840E-D200-B-BP	RF5LBE-840E-D200-B-BP	672,00
200	4000K	On/Off	High	2660lm/23W	2,8	RF5LWE-840H-D200-B-BP	RF5LBE-840H-D200-B-BP	672,00
270	4000K	On/Off	Low	1860lm/15W	3,8	RF5LWE-840E-D270-B-BP	RF5LBE-840E-D270-B-BP	847,00
270	4000K	On/Off	High	3110lm/26W	3,8	RF5LWE-840H-D270-B-BP	RF5LBE-840H-D270-B-BP	847,00
370	4000K	On/Off	Low	2480lm/20W	5,0	RF5LWE-840E-D370-B-BP	RF5LBE-840E-D370-B-BP	1075,00
370	4000K	On/Off	High	4140lm/34W	5,0	RF5LWE-840H-D370-B-BP	RF5LBE-840H-D370-B-BP	1075,00



Midpin Spotlight XD
770lm/10W/Ø40mm

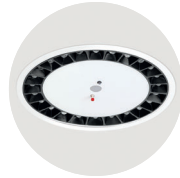

EM Emergency Module



MM Multisensor



AS Air Supply



Speaker (white or black)



Camera

Surcharges

Surface Finish	CHF	Control Gear	CHF	Colour Temperature	CHF	Lens Louvre	CHF	Central Module	CHF
W: Snow White	✓	E: On/Off	✓	22: 2200K	+5%	W: Snow White	✓	BP: Blind Plate	✓
V: Ivory White	✓	L: DALI	+86,00	27: 2700K	+5%	A: Satin Silver	✓	EM: Emergency Module	+366,00
A: Satin Silver	+15%	H: Touch-Dim	+86,00	30: 3000K	✓	B: Jet Black	✓	MP: Midpin Spotlight XD	+368,00
S: Radiant Silver	✓	Colour Rendering	CHF	35: 3500K	+5%	H: Anodic Champagne	✓	MM: Multisensor	+261,00
U: Urban Graphite	✓	8: CRI>80	✓	40: 4000K	✓	K: Satin Copper	✓	AS: Air Supply	ⓘ
B: Jet Black	✓	9: CRI>90	+5%	65: 6500K	+5%	G: Satin Gold	✓	Additional Options	CHF
H: Anodic Champagne	+10%	F: Full Spectrum	+15%					Casambi	+261,00
K: Satin Copper	+15%							Camera	ⓘ
R: Special RAL/NCS Colours	ⓘ							Speaker	ⓘ

✓ standard / no extra charge ⓘ on request ✗ not available

Ringo Star FX | System 40mm Recessed Frame

catalogue page 458

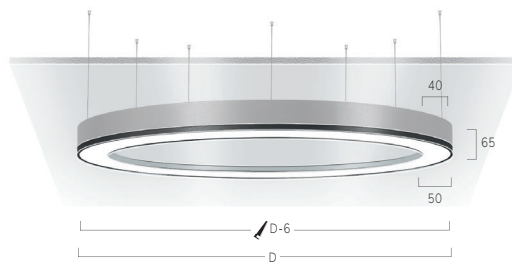

Lens Louvre | Direct

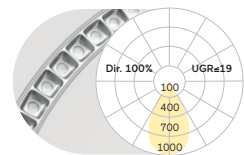

D mm	Colour Temperature	Control	Power	Lumen/Watt	Weight kg	Code Snow White/Jet Black	Code Jet Black/Jet Black	CHF
610	4000K	On/Off	Low	2850lm/23W	4,8	RFXLWE-840E-D610-B*	RFXLBE-840E-D610-B*	2629,00
610	4000K	On/Off	High	5170lm/42W	4,8	RFXLWE-840H-D610-B*	RFXLBE-840H-D610-B*	2629,00
910	4000K	On/Off	Low	4350lm/33W	7,2	RFXLWE-840E-D910-B*	RFXLBE-840E-D910-B*	3009,00
910	4000K	On/Off	High	7980lm/66W	7,2	RFXLWE-840H-D910-B*	RFXLBE-840H-D910-B*	3009,00
1255	4000K	On/Off	Low	6090lm/45W	10,0	RFXLWE-840E-D1255-B*	RFXLBE-840E-D1255-B*	3565,00
1255	4000K	On/Off	High	11170lm/90W	10,0	RFXLWE-840H-D1255-B*	RFXLBE-840H-D1255-B*	3565,00

Opal Flex Diffuser | Direct

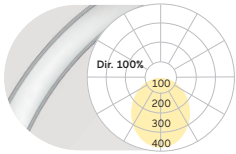

D mm	Colour Temperature	Control	Power	Lumen/Watt	Weight kg	Code Snow White	Code Jet Black	CHF
610	4000K	On/Off	Medium	2680lm/29W	4,8	RFXCWE-840M-D610	RFXCBE-840M-D610	2389,00
610	4000K	On/Off	High	3740lm/41W	4,8	RFXCWE-840H-D610	RFXCBE-840H-D610	2389,00
910	4000K	On/Off	Medium	4030lm/43W	7,2	RFXCWE-840M-D910	RFXCBE-840M-D910	2734,00
910	4000K	On/Off	High	5610lm/62W	7,2	RFXCWE-840H-D910	RFXCBE-840H-D910	2734,00
1255	4000K	On/Off	Medium	5820lm/62W	10,0	RFXCWE-840M-D1255	RFXCBE-840M-D1255	3240,00
1255	4000K	On/Off	High	7940lm/89W	10,0	RFXCWE-840H-D1255	RFXCBE-840H-D1255	3240,00
1510	4000K	On/Off	Medium	6730lm/71W	12,1	RFXCWE-840M-D1510	RFXCBE-840M-D1510	4127,00
1510	4000K	On/Off	High	9920lm/108W	12,1	RFXCWE-840H-D1510	RFXCBE-840H-D1510	4127,00
2010	4000K	On/Off	Medium	9400lm/100W	15,8	RFXCWE-840M-D2010	RFXCBE-840M-D2010	5158,00
2010	4000K	On/Off	High	13210lm/144W	15,8	RFXCWE-840H-D2010	RFXCBE-840H-D2010	5158,00

Surcharges

Surface Finish	CHF	Control Gear	CHF	CHF	Colour Rendering	CHF	Colour Temperature	CHF	Lens Louvre*	CHF
W: Snow White	✓	E: On/Off	✓	✓	8: CRI>80	✓	22: 2200K	+5%	W: Snow White	✓
V: Ivory White	✓	L: DALI	+86,00	+172,00	9: CRI>90	+5%	27: 2700K	+5%	A: Satin Silver	✓
A: Satin Silver	+15%	H: Touch-Dim	+86,00	+172,00	F: Full Spectrum	+15%	30: 3000K	✓	B: Jet Black	✓
S: Radiant Silver	✓	C: Casambi*	+261,00	+261,00			35: 3500K	+5%	H: Anodic Champagne	✓
U: Urban Graphite	✓						40: 4000K	✓	K: Satin Copper	✓
B: Jet Black	✓						65: 6500K	+5%	G: Satin Gold	✓
H: Anodic Champagne	+10%									
K: Satin Copper	+15%									
R: Special RAL/NCS Colours	ⓘ									

*Only in combination with DALI. Please add to dimming price.

✓ standard / no extra charge ⓘ on request ✗ not available

Ringo Star F1 | System 100mm Recessed Frame

catalogue page 462

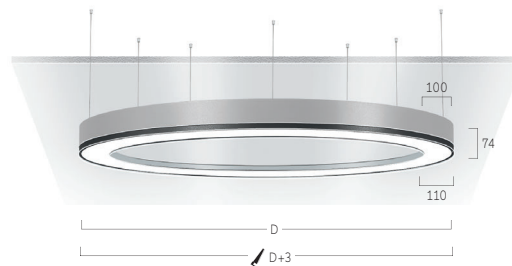
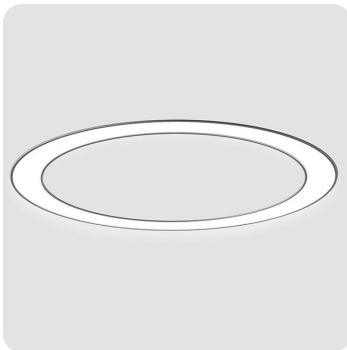

Microprismatic | Direct

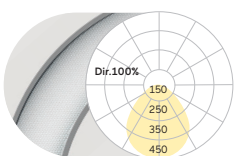

D mm	Colour Temperature	Control	Power	Lumen/Watt	Weight kg	Code Snow White	Code Radiant Silver	CHF
600	4000K	On/Off	Low	3810lm/34W	6,0	RF1AWE-840E-D600	RF1ASE-840E-D600	2305,00
600	4000K	On/Off	Medium	4790lm/45W	6,0	RF1AWE-840M-D600	RF1ASE-840M-D600	2305,00
900	4000K	On/Off	Low	6460lm/59W	7,0	RF1AWE-840E-D900	RF1ASE-840E-D900	3157,00
900	4000K	On/Off	Medium	7900lm/75W	7,0	RF1AWE-840M-D900	RF1ASE-840M-D900	3157,00
1200	4000K	On/Off	Low	8750lm/79W	12,0	RF1AWE-840E-D1200	RF1ASE-840E-D1200	4272,00
1200	4000K	On/Off	Medium	10260lm/95W	12,0	RF1AWE-840M-D1200	RF1ASE-840M-D1200	4272,00
1500	4000K	On/Off	Low	10980lm/98W	15,0	RF1AWE-840E-D1500	RF1ASE-840E-D1500	4958,00
1500	4000K	On/Off	Medium	13200lm/120W	15,0	RF1AWE-840M-D1500	RF1ASE-840M-D1500	4958,00
2000	4000K	On/Off	Low	14650lm/131W	20,0	RF1AWE-840E-D2000	RF1ASE-840E-D2000	7531,00
2000	4000K	On/Off	Medium	18330lm/168W	20,0	RF1AWE-840M-D2000	RF1ASE-840M-D2000	7531,00
2500	4000K	On/Off	Low	18900lm/166W	25,0	RF1AWE-840E-D2500	RF1ASE-840E-D2500	9363,00
2500	4000K	On/Off	Medium	23090lm/207W	25,0	RF1AWE-840M-D2500	RF1ASE-840M-D2500	9363,00
3000	4000K	On/Off	Low	23260lm/202W	30,0	RF1AWE-840E-D3000	RF1ASE-840E-D3000	11179,00
3000	4000K	On/Off	Medium	28420lm/252W	30,0	RF1AWE-840M-D3000	RF1ASE-840M-D3000	11179,00
3500	4000K	On/Off	Low	26170lm/227W	35,0	RF1AWE-840E-D3500	RF1ASE-840E-D3500	12611,00
3500	4000K	On/Off	Medium	31970lm/281W	35,0	RF1AWE-840M-D3500	RF1ASE-840M-D3500	12611,00
4000	4000K	On/Off	Low	30530lm/271W	40,0	RF1AWE-840E-D4000	RF1ASE-840E-D4000	14562,00
4000	4000K	On/Off	Medium	37290lm/338W	40,0	RF1AWE-840M-D4000	RF1ASE-840M-D4000	14562,00
5000	4000K	On/Off	Low	37800lm/332W	50,0	RF1AWE-840E-D5000	RF1ASE-840E-D5000	18076,00
5000	4000K	On/Off	Medium	46170lm/414W	50,0	RF1AWE-840M-D5000	RF1ASE-840M-D5000	18076,00
6000	4000K	On/Off	Low	46520lm/405W	60,0	RF1AWE-840E-D6000	RF1ASE-840E-D6000	21669,00
6000	4000K	On/Off	Medium	56830lm/504W	60,0	RF1AWE-840M-D6000	RF1ASE-840M-D6000	21669,00
7000	4000K	On/Off	Low	55240lm/496W	70,0	RF1AWE-840E-D7000	RF1ASE-840E-D7000	25108,00
7000	4000K	On/Off	Medium	67490lm/617W	70,0	RF1AWE-840M-D7000	RF1ASE-840M-D7000	25108,00
8000	4000K	On/Off	Low	61780lm/536W	80,0	RF1AWE-840E-D8000	RF1ASE-840E-D8000	28660,00
8000	4000K	On/Off	Medium	75480lm/667W	80,0	RF1AWE-840M-D8000	RF1ASE-840M-D8000	28660,00

... Ringo Star F1 | System 100mm Recessed Frame

Opal Diffuser | Direct

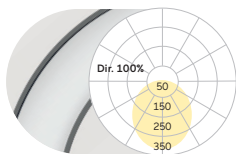

D mm	Colour Temperature	Control	Power	Lumen/Watt	Weight kg	Code Snow White	Code Radiant Silver	CHF
600	4000K	On/Off	Low	4090lm/34W	6,0	RF10WE-840E-D600	RF10SE-840E-D600	2211,00
600	4000K	On/Off	Medium	5150lm/45W	6,0	RF10WE-840M-D600	RF10SE-840M-D600	2211,00
900	4000K	On/Off	Low	6930lm/59W	7,0	RF10WE-840E-D900	RF10SE-840E-D900	2972,00
900	4000K	On/Off	Medium	8490lm/75W	7,0	RF10WE-840M-D900	RF10SE-840M-D900	2972,00
1200	4000K	On/Off	Low	9400lm/79W	12,0	RF10WE-840E-D1200	RF10SE-840E-D1200	3994,00
1200	4000K	On/Off	Medium	11030lm/95W	12,0	RF10WE-840M-D1200	RF10SE-840M-D1200	3994,00
1500	4000K	On/Off	Low	11800lm/98W	15,0	RF10WE-840E-D1500	RF10SE-840E-D1500	4561,00
1500	4000K	On/Off	Medium	14180lm/120W	15,0	RF10WE-840M-D1500	RF10SE-840M-D1500	4561,00
2000	4000K	On/Off	Low	15730lm/131W	20,0	RF10WE-840E-D2000	RF10SE-840E-D2000	7053,00
2000	4000K	On/Off	Medium	19690lm/168W	20,0	RF10WE-840M-D2000	RF10SE-840M-D2000	7053,00
2500	4000K	On/Off	Low	20300lm/166W	25,0	RF10WE-840E-D2500	RF10SE-840E-D2500	8791,00
2500	4000K	On/Off	Medium	24800lm/207W	25,0	RF10WE-840M-D2500	RF10SE-840M-D2500	8791,00
3000	4000K	On/Off	Low	24990lm/202W	30,0	RF10WE-840E-D3000	RF10SE-840E-D3000	10509,00
3000	4000K	On/Off	Medium	30520lm/252W	30,0	RF10WE-840M-D3000	RF10SE-840M-D3000	10509,00
3500	4000K	On/Off	Low	28110lm/227W	35,0	RF10WE-840E-D3500	RF10SE-840E-D3500	11848,00
3500	4000K	On/Off	Medium	34340lm/281W	35,0	RF10WE-840M-D3500	RF10SE-840M-D3500	11848,00
4000	4000K	On/Off	Low	32790lm/271W	40,0	RF10WE-840E-D4000	RF10SE-840E-D4000	13703,00
4000	4000K	On/Off	Medium	40060lm/338W	40,0	RF10WE-840M-D4000	RF10SE-840M-D4000	13703,00
5000	4000K	On/Off	Low	40600lm/332W	50,0	RF10WE-840E-D5000	RF10SE-840E-D5000	17121,00
5000	4000K	On/Off	Medium	49600lm/414W	50,0	RF10WE-840M-D5000	RF10SE-840M-D5000	17121,00
6000	4000K	On/Off	Low	49970lm/405W	60,0	RF10WE-840E-D6000	RF10SE-840E-D6000	20619,00
6000	4000K	On/Off	Medium	61050lm/504W	60,0	RF10WE-840M-D6000	RF10SE-840M-D6000	20619,00
7000	4000K	On/Off	Low	59340lm/496W	70,0	RF10WE-840E-D7000	RF10SE-840E-D7000	23961,00
7000	4000K	On/Off	Medium	72500lm/617W	70,0	RF10WE-840M-D7000	RF10SE-840M-D7000	23961,00
8000	4000K	On/Off	Low	66370lm/536W	80,0	RF10WE-840E-D8000	RF10SE-840E-D8000	27419,00
8000	4000K	On/Off	Medium	81080lm/667W	80,0	RF10WE-840M-D8000	RF10SE-840M-D8000	27419,00

Surcharges

Surface Finish

- W: Snow White
- V: Ivory White
- S: Radiant Silver
- U: Urban Graphite
- B: Jet Black
- H: Anodic Champagne
- K: Satin Copper
- R: Special RAL/NCS Colours

CHF	Control Gear	CHF	CHF	CHF
	E: On/Off			
	L: DALI	+86,00	+172,00	
	H: Touch-Dim	+86,00	+172,00	
	C: Casambi*	+261,00	+261,00	
	G: DALI DT6 for TW	+172,00	+343,00	
	8: DALI DT8 for TW [D900-D8000]	+172,00	+343,00	

*Only in combination with DALI. Please add to dimming price.

Colour Temperature	CHF
22: 2200K	+5%
27: 2700K	+5%
30: 3000K	
35: 3500K	+5%
40: 4000K	
65: 6500K	+5%
TW: Tunable White 2700-6500K*	+30%

*Only in combination with DT6, DT8 or Casambi control. Please add additional control price.

Colour Rendering	CHF
8: CRI>80	
9: CRI>90	+5%
F: Full Spectrum	+15%

Additional Options

Additional Options	CHF
Emergency Module [DALI, Autotest, incl. 3H Battery] [D900-D8000]	+366,00

✓ standard / no extra charge ⚠ on request ✗ not available

Liquid Line Compact F5 | Recessed Frame

catalogue page 464

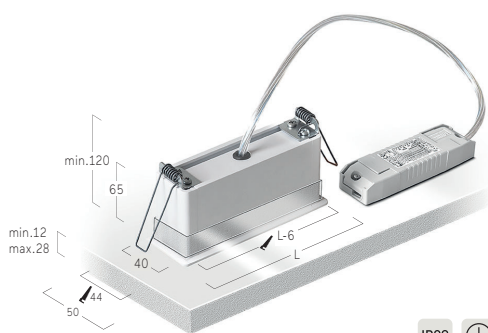

Lens Louvre | Direct

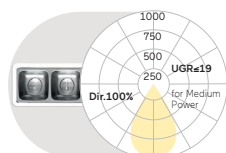

L mm	Colour Temperature	Control	Power	Lumen/Watt	Weight kg	Code Snow White/Jet Black	Code Jet Black/Jet Black	CHF
149	4000K	On/Off	Medium	620lm/7W	0,6	QF5LWE-840M-L149-B	QF5LBE-840M-L149-B	639,00
149	4000K	On/Off	High	820lm/9W	0,6	QF5LWE-840H-L149-B	QF5LBE-840H-L149-B	639,00
281	4000K	On/Off	Medium	1240lm/12W	1,0	QF5LWE-840M-L281-B	QF5LBE-840M-L281-B	1042,00
281	4000K	On/Off	High	1640lm/17W	1,0	QF5LWE-840H-L281-B	QF5LBE-840H-L281-B	1042,00
413	4000K	On/Off	Medium	1860lm/16W	1,3	QF5LWE-840M-L413-B	QF5LBE-840M-L413-B	1462,00
413	4000K	On/Off	High	2460lm/23W	1,3	QF5LWE-840H-L413-B	QF5LBE-840H-L413-B	1462,00

Surcharges

Surface Finish	CHF	Control Gear	CHF	Colour Rendering	CHF	Colour Temperature	CHF	Lens Louvre*	CHF
W: Snow White	✓	E: On/Off	✓	8: CRI>80	✓	22: 2200K	+5%	W: Snow White	✓
V: Ivory White	✓	L: DALI	+172,00	9: CRI>90	+5%	27: 2700K	+5%	A: Satin Silver	✓
A: Satin Silver	+15%	H: Touch-Dim	+172,00	F: Full Spectrum	+15%	30: 3000K	✓	B: Jet Black	✓
S: Radiant Silver	✓					35: 3500K	+5%	H: Anodic Champagne	✓
U: Urban Graphite	✓					40: 4000K	✓	G: Satin Gold	✓
B: Jet Black	✓					65: 6500K	+5%	K: Satin Copper	✓
H: Anodic Champagne	+10%								
K: Satin Copper	+15%								
R: Special RAL/NCS Colours	🔔								

✓ standard / no extra charge
🔔 on request
✗ not available

Liquid Line QX/FX | System 40mm Recessed

catalogue page **466**

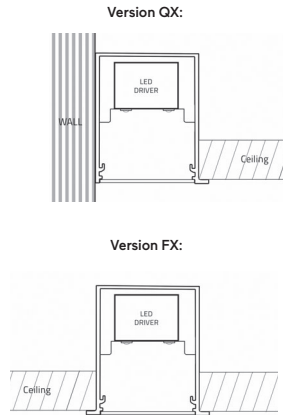
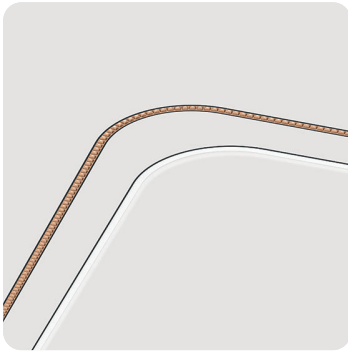

- DE** System aus linearen, vertikal und horizontal gebogenen Komponenten sowie Y- und X-Verbindungs-elementen. Auf Grundlage skizzierter Kundenvorgabe erstellt Lightnet technische Zeichnung der gewünschten Struktur zur Prüfung und Freigabe. Zeichnungen für mögliche Radien, X- und Y-Module siehe Katalog. Sonderradien bei Opal-Flex Diffuser möglich.
- EN** System consisting of linear elements, vertically and horizontally curved elements and Y- and X-connectors. Based on customer specification, Lightnet creates technical drawings of the desired structure for review and approval. For drawings of possible curves, X- and Y-modules, see catalog. Special curves possible for Opal-Flex diffuser.
- FR** Système d'éclairage sur-mesure des éléments/modules droits-linéaires, verticaux et horizontaux cintrés, tout comme des connections/jonctions en forme de Y et X. Sur la base des schémas et spécifications voulues par le client, Lightnet créer les dessins techniques de la structure sur-mesure souhaitée pour contrôle et validation avant mise en production. Pour les dessins des rayons possibles et des modules X et Y, voir le catalogue. Rayons spéciaux possibles pour les diffusCHFs Opal-Flex.

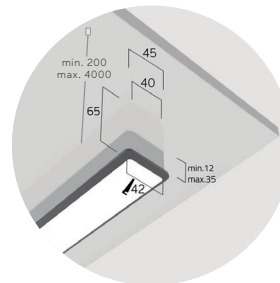

Version QX

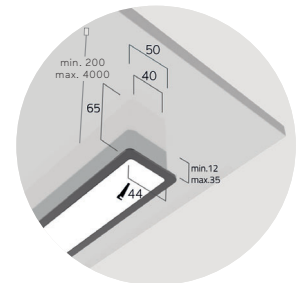

Version FX

QX Lens Louvre | Direct

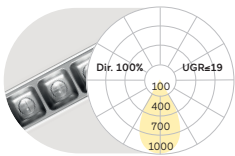

L mm	Colour Temperature	Control	Power	Lumen/Watt	Weight kg	Code Snow White/Jet Black	Code Jet Black/Jet Black	CHF
Liquid Line per meter (Lineare Teilstücke Straight Sections Sections droites)								
per meter	4000K	On/Off	Low	1640lm/12,6W	2,3	QQXLWE-840E-L****-B*	QQXLBE-840E-L****-B*	664,00
per meter	4000K	On/Off	High	3020lm/24,3W	2,3	QQXLWE-840H-L****-B*	QQXLBE-840H-L****-B*	664,00
per meter	4000K	DALI	Low	1640lm/12,6W	2,3	QQXLWL-840E-L****-B*	QQXLBL-840E-L****-B*	716,00
per meter	4000K	DALI	High	3020lm/24,3W	2,3	QQXLWL-840H-L****-B*	QQXLBL-840H-L****-B*	716,00
Liquid Line per meter (Gebogene Teilstücke Curved and bent Sections Courbes Sections)								
per meter	4000K	On/Off	Low	1640lm/12,6W	2,3	QQXLWE-840E-L****-B*	QQXLBE-840E-L****-B*	1222,00
per meter	4000K	On/Off	High	3020lm/24,3W	2,3	QQXLWE-840H-L****-B*	QQXLBE-840H-L****-B*	1222,00
per meter	4000K	DALI	Low	1640lm/12,6W	2,3	QQXLWL-840E-L****-B*	QQXLBL-840E-L****-B*	1274,00
per meter	4000K	DALI	High	3020lm/24,3W	2,3	QQXLWL-840H-L****-B*	QQXLBL-840H-L****-B*	1274,00

FX Lens Louvre | Direct

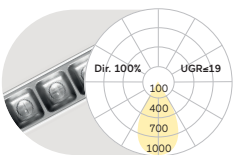

L mm	Colour Temperature	Control	Power	Lumen/Watt	Weight kg	Code Snow White/Jet Black	Code Jet Black/Jet Black	CHF
Liquid Line per meter (Lineare Teilstücke Straight Sections Sections droites)								
per meter	4000K	On/Off	Low	1640lm/12,6W	2,3	QFXLWE-840E-L****-B*	QFXLBE-840E-L****-B*	664,00
per meter	4000K	On/Off	High	3020lm/24,3W	2,3	QFXLWE-840H-L****-B*	QFXLBE-840H-L****-B*	664,00
per meter	4000K	DALI	Low	1640lm/12,6W	2,3	QFXLWL-840E-L****-B*	QFXLBL-840E-L****-B*	716,00
per meter	4000K	DALI	High	3020lm/24,3W	2,3	QFXLWL-840H-L****-B*	QFXLBL-840H-L****-B*	716,00
Liquid Line per meter (Gebogene Teilstücke Curved and bent Sections Courbes Sections)								
per meter	4000K	On/Off	Low	1640lm/12,6W	2,3	QFXLWE-840E-L****-B*	QFXLBE-840E-L****-B*	1222,00
per meter	4000K	On/Off	High	3020lm/24,3W	2,3	QFXLWE-840H-L****-B*	QFXLBE-840H-L****-B*	1222,00
per meter	4000K	DALI	Low	1640lm/12,6W	2,3	QFXLWL-840E-L****-B*	QFXLBL-840E-L****-B*	1274,00
per meter	4000K	DALI	High	3020lm/24,3W	2,3	QFXLWL-840H-L****-B*	QFXLBL-840H-L****-B*	1274,00

**** Your length in mm

Meterpreise für Lichtsysteme nach Maß ab Mindestlänge 2200mm | Prices per metre for customised lighting systems with a minimum length of 2200mm
 Prix au mètre pour systèmes d'éclairage sur mesure à partir d'une longueur minimale de 2200mm

... Liquid Line QX/FX | System 40mm Recessed

QX Opal Flex Diffuser | Direct

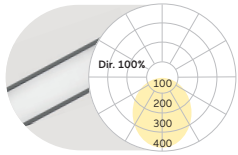

L mm	Colour Temperature	Control	Power	Lumen/Watt	Weight kg	Code Snow White	Code Jet Black	CHF
Liquid Line per meter (Lineare Teilstücke Straight Sections Sections droites)								
per meter	4000K	On/Off	Medium	1550lm/15,6W	2,3	QQXCWE-840M-L****	QQXCBE-840M-L****	524,00
per meter	4000K	On/Off	High	2150lm/21,8W	2,3	QQXCWE-840H-L****	QQXCBE-840H-L****	524,00
per meter	4000K	DALI	Medium	1550lm/15,6W	2,3	QQXCWL-840M-L****	QQXCBL-840M-L****	594,00
per meter	4000K	DALI	High	2150lm/21,8W	2,3	QQXCWL-840H-L****	QQXCBL-840H-L****	594,00
Liquid Line per meter (Gebogene Teilstücke Curved and bent Sections Courbes Sections)								
per meter	4000K	On/Off	Medium	1550lm/15,6W	2,3	QQXCWE-840M-L****	QQXCBE-840M-L****	874,00
per meter	4000K	On/Off	High	2150lm/21,8W	2,3	QQXCWE-840H-L****	QQXCBE-840H-L****	874,00
per meter	4000K	DALI	Medium	1550lm/15,6W	2,3	QQXCWL-840M-L****	QQXCBL-840M-L****	926,00
per meter	4000K	DALI	High	2150lm/21,8W	2,3	QQXCWL-840H-L****	QQXCBL-840H-L****	926,00
Zusätzlicher Preis per X-Junction Module Additional Price per X-Junction Module Prix supplémentaire par module X-Junction								+438,00
Zusätzlicher Preis per Y-Junction Module Additional Price per Y-Junction Module Prix supplémentaire par module Y-Junction								+385,00

FX Opal Flex Diffuser | Direct

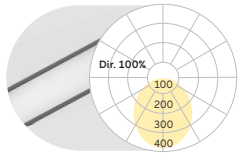

L mm	Colour Temperature	Control	Power	Lumen/Watt	Weight kg	Code Snow White	Code Jet Black	CHF
Liquid Line per meter (Lineare Teilstücke Straight Sections Sections droites)								
per meter	4000K	On/Off	Medium	1550lm/15,6W	2,3	QFXCWE-840M-L****	QFXCBE-840M-L****	524,00
per meter	4000K	On/Off	High	2150lm/21,8W	2,3	QFXCWE-840H-L****	QFXCBE-840H-L****	524,00
per meter	4000K	DALI	Medium	1550lm/15,6W	2,3	QFXCWL-840M-L****	QFXCBL-840M-L****	594,00
per meter	4000K	DALI	High	2150lm/21,8W	2,3	QFXCWL-840H-L****	QFXCBL-840H-L****	594,00
Liquid Line per meter (Gebogene Teilstücke Curved and bent Sections Courbes Sections)								
per meter	4000K	On/Off	Medium	1550lm/15,6W	2,3	QFXCWE-840M-L****	QFXCBE-840M-L****	874,00
per meter	4000K	On/Off	High	2150lm/21,8W	2,3	QFXCWE-840H-L****	QFXCBE-840H-L****	874,00
per meter	4000K	DALI	Medium	1550lm/15,6W	2,3	QFXCWL-840M-L****	QFXCBL-840M-L****	926,00
per meter	4000K	DALI	High	2150lm/21,8W	2,3	QFXCWL-840H-L****	QFXCBL-840H-L****	926,00
Zusätzlicher Preis per X-Junction Module Additional Price per X-Junction Module Prix supplémentaire par module X-Junction								+438,00
Zusätzlicher Preis per Y-Junction Module Additional Price per Y-Junction Module Prix supplémentaire par module Y-Junction								+385,00

**** Your length in mm

Meterpreise für Lichtsysteme nach Maß ab Mindestlänge 2200mm | Prices per metre for customised lighting systems with a minimum length of 2200mm
 Prix au mètre pour systèmes d'éclairage sur mesure à partir d'une longueur minimale de 2200mm



Linear Module



Curve Module (Opal-Flex)



Curve Module (Louvre)



Bend Module



X-Junction Module (Opal-Flex)



Y-Junction Module (Opal-Flex)

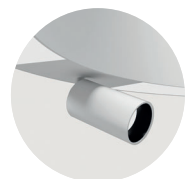

Midpin Spotlight XM



B Jet Black
W Snow White



B Jet Black
A Satin Silver



B Jet Black
B Jet Black

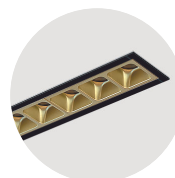

B Jet Black
G Satin Gold



B Jet Black
H Anodic Champagne



B Jet Black
K Satin Copper

Surcharges

Surface Finish	CHF	Control Gear	CHF	Colour Temperature	CHF	Reflector Colour	CHF	Additional Options	CHF
W: Snow White	✓	E: On/Off	✓	22: 2200K	+5%	W: Snow White	✓	Midpin Spotlight XM	+363,00
V: Ivory White	✓	L: DALI	✓	27: 2700K	+5%	A: Satin Silver	✓		
A: Satin Silver	+15%	H: Touch-Dim	⚡	30: 3000K	✓	B: Jet Black	✓		
U: Urban Graphite	✓	C: Casambi	⚡	35: 3500K	+5%	H: Anodic Champagne	✓		
B: Jet Black	✓	Colour Rendering	CHF	40: 4000K	✓	K: Satin Copper	✓		
H: Anodic Champagne	+10%	8: CRI>80	✓	65: 6500K	+5%	G: Satin Gold	✓		
K: Satin Copper	+15%	9: CRI>90	+5%						
R: Special RAL/NCS Colours	⚡	F: Full Spectrum	+15%						

✓ standard / no extra charge ⚡ on request ✗ not available

Liquid Line F3 | System 60mm Recessed

catalogue page 474

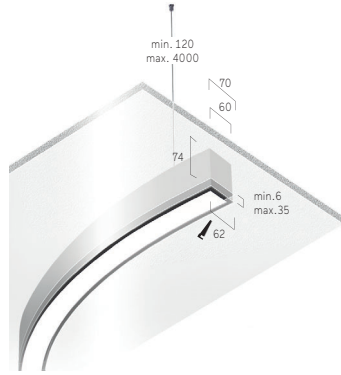

DE System aus linearen, vertikal und horizontal gebogenen Komponenten sowie Y- und X-Verbindungselementen. Auf Grundlage skizzierter Kundenvorgabe erstellt Lightnet technische Zeichnung der gewünschten Struktur zur Prüfung und Freigabe. Zeichnungen für mögliche Radien, X- und Y-Module siehe Katalog. Sonderradien bei Opal-Flex Diffuser möglich.

EN System consisting of linear elements, vertically and horizontally curved elements and Y- and X-connectors. Based on customer specification, Lightnet creates technical drawings of the desired structure for review and approval. For drawings of possible curves, X- and Y-modules, see catalog. Special curves possible for Opal-Flex diffuser.

FR Système d'éclairage sur-mesure des éléments/modules droits-linéaires, verticaux et horizontaux cintrés, tout comme des connections/jonctions en forme de Y et X. Sur la base des schémas et spécifications voulues par le client, Lightnet crée les dessins techniques de la structure sur-mesure souhaitée pour contrôle et validation avant mise en production. Pour les dessins des rayons possibles et des modules X et Y, voir le catalogue. Rayons spéciaux possibles pour les diffusCHFs Opal-Flex.



Microprismatic | Direct

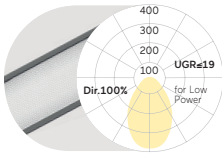

L mm	Colour Temperature	Control	Power	Lumen/Watt	Weight kg	Code Snow White	Code Jet Black	CHF
Liquid Line per meter (Lineare Teilstücke Straight Sections Sections droites)								
per meter	4000K	On/Off	Low	1200lm/14,6W	3,5	QF3AWE-840E-L****	QF3ABE-840E-L****	681,00
per meter	4000K	On/Off	Medium	1760lm/22,5W	3,5	QF3AWE-840M-L****	QF3ABE-840M-L****	681,00
per meter	4000K	On/Off	High	2290lm/30,3W	3,5	QF3AWE-840H-L****	QF3ABE-840H-L****	681,00
per meter	4000K	DALI	Low	1200lm/14,6W	3,5	QF3AWL-840E-L****	QF3ABL-840E-L****	734,00
per meter	4000K	DALI	Medium	1760lm/22,5W	3,5	QF3AWL-840M-L****	QF3ABL-840M-L****	734,00
per meter	4000K	DALI	High	2290lm/30,3W	3,5	QF3AWL-840H-L****	QF3ABL-840H-L****	734,00
Liquid Line per meter (Gebogene Teilstücke Curved and bent Sections Courbes Sections)								
per meter	4000K	On/Off	Low	1200lm/14,6W	3,5	QF3AWE-840E-L****	QF3ABE-840E-L****	1031,00
per meter	4000K	On/Off	Medium	1760lm/22,5W	3,5	QF3AWE-840M-L****	QF3ABE-840M-L****	1031,00
per meter	4000K	On/Off	High	2290lm/30,3W	3,5	QF3AWE-840H-L****	QF3ABE-840H-L****	1031,00
per meter	4000K	DALI	Low	1200lm/14,6W	3,5	QF3AWL-840E-L****	QF3ABL-840E-L****	1084,00
per meter	4000K	DALI	Medium	1760lm/22,5W	3,5	QF3AWL-840M-L****	QF3ABL-840M-L****	1084,00
per meter	4000K	DALI	High	2290lm/30,3W	3,5	QF3AWL-840H-L****	QF3ABL-840H-L****	1084,00
Zusätzlicher Preis per X-Junction Module Additional Price per X-Junction Module Prix supplémentaire par module X-Junction								+438,00
Zusätzlicher Preis per Y-Junction Module Additional Price per Y-Junction Module Prix supplémentaire par module Y-Junction								+385,00

Opal Diffuser | Direct

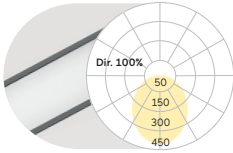

L mm	Colour Temperature	Control	Power	Lumen/Watt	Weight kg	Code Snow White	Code Jet Black	CHF
Liquid Line per meter (Lineare Teilstücke Straight Sections Sections droites)								
per meter	4000K	On/Off	Low	1300lm/14,6W	3,5	QF3OWE-840E-L****	QF3OBE-840E-L****	646,00
per meter	4000K	On/Off	Medium	1910lm/22,5W	3,5	QF3OWE-840M-L****	QF3OBE-840M-L****	646,00
per meter	4000K	On/Off	High	2480lm/30,3W	3,5	QF3OWE-840H-L****	QF3OBE-840H-L****	646,00
per meter	4000K	DALI	Low	1300lm/14,6W	3,5	QF3OWL-840E-L****	QF3OBL-840E-L****	699,00
per meter	4000K	DALI	Medium	1910lm/22,5W	3,5	QF3OWL-840M-L****	QF3OBL-840M-L****	699,00
per meter	4000K	DALI	High	2480lm/30,3W	3,5	QF3OWL-840H-L****	QF3OBL-840H-L****	699,00
Liquid Line per meter (Gebogene Teilstücke Curved and bent Sections Courbes Sections)								
per meter	4000K	On/Off	Low	1300lm/14,6W	3,5	QF3OWE-840E-L****	QF3OBE-840E-L****	996,00
per meter	4000K	On/Off	Medium	1910lm/22,5W	3,5	QF3OWE-840M-L****	QF3OBE-840M-L****	996,00
per meter	4000K	On/Off	High	2480lm/30,3W	3,5	QF3OWE-840H-L****	QF3OBE-840H-L****	996,00
per meter	4000K	DALI	Low	1300lm/14,6W	3,5	QF3OWL-840E-L****	QF3OBL-840E-L****	1049,00
per meter	4000K	DALI	Medium	1910lm/22,5W	3,5	QF3OWL-840M-L****	QF3OBL-840M-L****	1049,00
per meter	4000K	DALI	High	2480lm/30,3W	3,5	QF3OWL-840H-L****	QF3OBL-840H-L****	1049,00
Zusätzlicher Preis per X-Junction Module Additional Price per X-Junction Module Prix supplémentaire par module X-Junction								+438,00
Zusätzlicher Preis per Y-Junction Module Additional Price per Y-Junction Module Prix supplémentaire par module Y-Junction								+385,00

**** Your length in mm
 Meterpreise für Lichtsysteme nach Maß ab Mindestlänge 2200mm | Prices per metre for customised lighting systems with a minimum length of 2200mm
 Prix au mètre pour systèmes d'éclairage sur mesure à partir d'une longueur minimale de 2200mm



Linear Module



Corner Module



Curve Module



Curve Module



Bend Module



Bend Module



X-Junction Module



X-Junction Module



Y-Junction Module

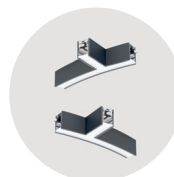

Y-Junction Module

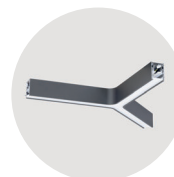

Y-Junction Module

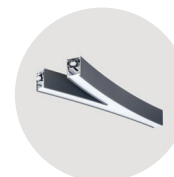

Y-Junction Module

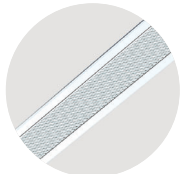

W Snow White

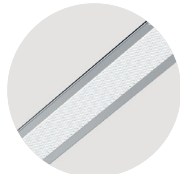

S Radiant Silver

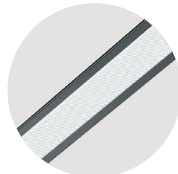

U Urban Graphite



B Jet Black

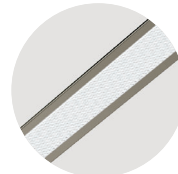

H Anodic Champagne



K Satin Copper

Surcharges

Surface Finish	CHF
W: Snow White	✓
V: Ivory White	✓
A: Satin Silver	+15%
U: Urban Graphite	✓
B: Jet Black	✓
H: Anodic Champagne	+10%
K: Satin Copper	+15%
R: Special RAL/NCS Colours	🔴

Control Gear	CHF
E: On/Off	✓
L: DALI	+86,00
H: Touch-Dim	+86,00
C: Casambi*	+261,00

*Only in combination with DALI. Please add to dimming price.

Colour Rendering	CHF
8: CRI>80	✓
9: CRI>90	+5%
F: Full Spectrum	+15%

Colour Temperature	CHF
22: 2200K	+5%
27: 2700K	+5%
30: 3000K	✓
35: 3500K	+5%
40: 4000K	✓
65: 6500K	+5%

✓ standard / no extra charge 🔴 on request ✗ not available

Caleo Max M2 | Recessed Frameless

catalogue page **478**

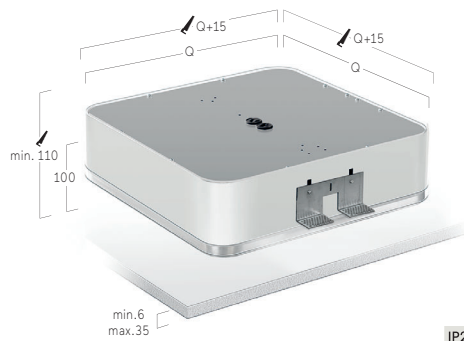

Microprismatic | Direct

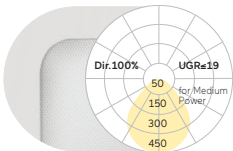

Q mm	Colour Temperature	Control	Power	Lumen/Watt	Weight kg	Code Snow White	CHF
340	4000K	On/Off	Medium	1230lm/12W	3,5	AM2AWE-840M-Q340	559,00
340	4000K	On/Off	High	1810lm/18W	3,5	AM2AWE-840H-Q340	559,00
420	4000K	On/Off	Medium	2010lm/19W	5,0	AM2AWE-840M-Q420	667,00
420	4000K	On/Off	High	2920lm/27W	5,0	AM2AWE-840H-Q420	667,00
612	4000K	On/Off	Medium	4580lm/40W	7,0	AM2AWE-840M-Q612	900,00
612	4000K	On/Off	High	7250lm/65W	7,0	AM2AWE-840H-Q612	900,00

Opal Diffuser | Direct

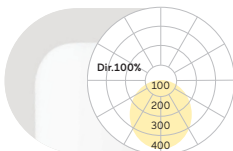

Q mm	Colour Temperature	Control	Power	Lumen/Watt	Weight kg	Code Snow White	CHF
340	4000K	On/Off	Medium	1390lm/12W	3,5	AM2OWE-840M-Q340	522,00
340	4000K	On/Off	High	2050lm/18W	3,5	AM2OWE-840H-Q340	522,00
420	4000K	On/Off	Medium	2280lm/19W	5,0	AM2OWE-840M-Q420	630,00
420	4000K	On/Off	High	3310lm/27W	5,0	AM2OWE-840H-Q420	630,00
612	4000K	On/Off	Medium	5180lm/40W	7,0	AM2OWE-840M-Q612	784,00
612	4000K	On/Off	High	8220lm/65W	7,0	AM2OWE-840H-Q612	784,00

Surcharges

Control Gear	CHF
E: On/Off	✓
H: Touch-Dim	+86,00
L: DALI	+86,00
6: DALI DT6 for TW	+172,00
8: DALI DT8 for TW	+172,00
C: Casambi*	+261,00

*Only in combination with DALI. Please add to dimming price.

Colour Rendering	CHF
8: CRI>80	✓
9: CRI>90	+5%
F: Full Spectrum	+15%

Colour Temperature	CHF
22: 2200K	+5%
27: 2700K	+5%
30: 3000K	✓
35: 3500K	+5%
40: 4000K	✓
65: 6500K	+5%
TW: Tunable White 2700-6500K*	+30%

*Only in combination with DT6, DT8 or Casambi control. Please add additional control price.

Additional Options	CHF
Radar Sensor	+209,00
Emergency Module [DALI, Autotest, incl. 3H Battery]	+366,00

✓ standard / no extra charge 🔴 on request ✗ not available

Cubic Max M2 | Recessed Frameless

catalogue page 480

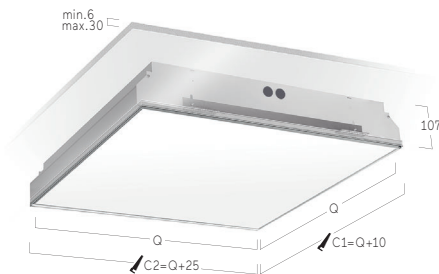
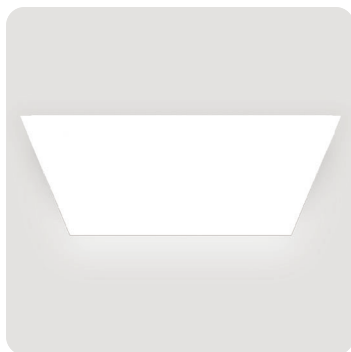

Microprismatic | Direct

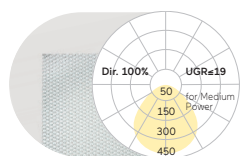

Q mm	Colour Temperature	Control	Power	Lumen/Watt	Weight kg	Code Snow White	CHF
340	4000K	On/Off	Medium	1340lm/12W	3,0	CM2AWE-840M-Q340	518,00
340	4000K	On/Off	High	1980lm/18W	3,0	CM2AWE-840H-Q340	518,00
420	4000K	On/Off	Medium	2200lm/19W	4,5	CM2AWE-840M-Q420	611,00
420	4000K	On/Off	High	3200lm/27W	4,5	CM2AWE-840H-Q420	611,00
612	4000K	On/Off	Medium	5010lm/40W	6,5	CM2AWE-840M-Q612	833,00
612	4000K	On/Off	High	7940lm/65W	6,5	CM2AWE-840H-Q612	833,00

Opal Diffuser | Direct

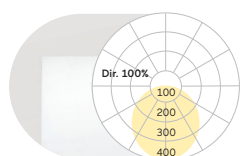

Q mm	Colour Temperature	Control	Power	Lumen/Watt	Weight kg	Code Snow White	CHF
340	4000K	On/Off	Medium	1420lm/12W	3,0	CM2OWE-840M-Q340	482,00
340	4000K	On/Off	High	2090lm/18W	3,0	CM2OWE-840H-Q340	482,00
420	4000K	On/Off	Medium	2320lm/19W	4,5	CM2OWE-840M-Q420	574,00
420	4000K	On/Off	High	3370lm/27W	4,5	CM2OWE-840H-Q420	574,00
612	4000K	On/Off	Medium	5280lm/40W	6,5	CM2OWE-840M-Q612	714,00
612	4000K	On/Off	High	8360lm/65W	6,5	CM2OWE-840H-Q612	714,00

Surcharges

Control Gear	CHF	Colour Rendering	CHF	Colour Temperature	CHF	Additional Options	CHF
E: On/Off	✓	8: CRI>80	✓	22: 2200K	+5%	Emergency Module [DALI, Autotest, incl. 3H Battery]	+366,00
H: Touch-Dim	+86,00	9: CRI>90	+5%	27: 2700K	+5%		
L: DALI	+86,00	F: Full Spectrum	+15%	30: 3000K	✓		
G: DALI DT6 for TW	+172,00			35: 3500K	+5%		
B: DALI DT8 for TW	+172,00			40: 4000K	✓		
C: Casambi*	+261,00			65: 6500K	+5%		
				TW: Tunable White 2700-6500K*	+30%		

*Only in combination with DALI. Please add to dimming price.

*Only in combination with DT6, DT8 or Casambi control. Please add additional control price.

✓ standard / no extra charge ⚡ on request ✖ not available

Cubic Max M4 | Recessed Frame

catalogue page 482

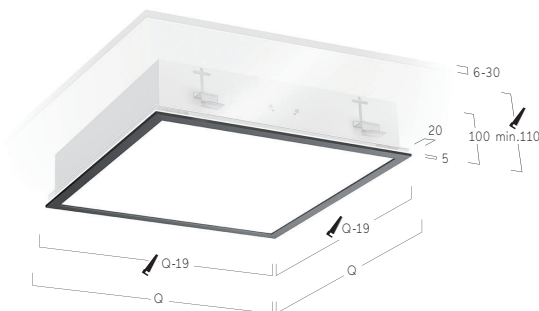

Microprismatic | Direct

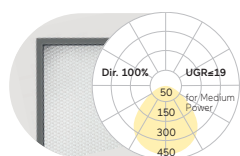

Q mm	Colour Temperature	Control	Power	Lumen/Watt	Weight kg	Code Snow White	Code Silver Anodised	CHF
379	4000K	On/Off	Medium	1310lm/12W	4,3	CM4AWE-840M-Q379	CM4AEE-840M-Q379	541,00
379	4000K	On/Off	High	1940lm/18W	4,3	CM4AWE-840H-Q379	CM4AEE-840H-Q379	541,00
479	4000K	On/Off	Medium	2150lm/19W	6,8	CM4AWE-840M-Q479	CM4AEE-840M-Q479	632,00
479	4000K	On/Off	High	3130lm/27W	6,8	CM4AWE-840H-Q479	CM4AEE-840H-Q479	632,00
621	4000K	On/Off	Medium	4720lm/38W	8,2	CM4AWE-840M-Q621	CM4AEE-840M-Q621	928,00
621	4000K	On/Off	High	6930lm/58W	8,2	CM4AWE-840H-Q621	CM4AEE-840H-Q621	928,00
910	4000K	On/Off	Medium	7770lm/67W	13,0	CM4AWE-840M-Q910	CM4AEE-840M-Q910	2022,00
910	4000K	On/Off	High	12840lm/129W	13,0	CM4AWE-840H-Q910	CM4AEE-840H-Q910	2022,00

... Cubic Max M4 | Recessed Frame

Opal Diffuser | Direct

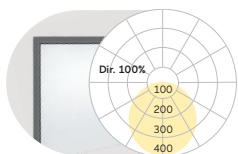

Q mm	Colour Temperature	Control	Power	Lumen/Watt	Weight kg	Code Snow White	Code Silver Anodised	CHF
379	4000K	On/Off	Medium	1350lm/12W	4,3	CM4OWE-840M-Q379	CM4OEE-840M-Q379	508,00
379	4000K	On/Off	High	1990lm/18W	4,3	CM4OWE-840H-Q379	CM4OEE-840H-Q379	508,00
479	4000K	On/Off	Medium	2210lm/19W	6,8	CM4OWE-840M-Q479	CM4OEE-840M-Q479	608,00
479	4000K	On/Off	High	3210lm/27W	6,8	CM4OWE-840H-Q479	CM4OEE-840H-Q479	608,00
621	4000K	On/Off	Medium	4850lm/38W	8,2	CM4OWE-840M-Q621	CM4OEE-840M-Q621	882,00
621	4000K	On/Off	High	7120lm/58W	8,2	CM4OWE-840H-Q621	CM4OEE-840H-Q621	882,00
910	4000K	On/Off	Medium	7980lm/67W	13,0	CM4OWE-840M-Q910	CM4OEE-840M-Q910	1852,00
910	4000K	On/Off	High	13190lm/129W	13,0	CM4OWE-840H-Q910	CM4OEE-840H-Q910	1852,00

Surcharges

Surface Finish	CHF	Control Gear	CHF	CHF	Colour Rendering	CHF	Colour Temperature	CHF	Additional Options	CHF
W: Snow White	✓	E: On/Off	Q379-Q621	Q910	8: CRI>80	✓	22: 2200K	+5%	Emergency Module [DALI, Autotest, incl. 3H Battery]	+366,00
E: Silver Anodised	✓	H: Touch-Dim	+86,00	+172,00	9: CRI>90	+5%	27: 2700K	+5%		
U: Urban Graphite	✓	L: DALI	+86,00	+172,00	F: Full Spectrum	+15%	30: 3000K	✓		
B: Jet Black	✓	6: DALI DT6 for TW	+172,00	+343,00			35: 3500K	+5%		
H: Anodic Champagne	+10%	8: DALI DT8 for TW	+172,00	+343,00			40: 4000K	✓		
R: Special RAL/NCS Colours	ⓘ	C: Casambi*	+261,00	+261,00			65: 6500K	+5%		
							TW: Tunable White 2700-6500K*	+30%		

*Only in combination with DALI. Please add to dimming price.

*Only in combination with DT6, DT8 or Casambi control. Please add additional control price.

✓ standard / no extra charge ⓘ on request ✗ not available

Cubic M7 | Ambient Recessed Frame

catalogue page **484**

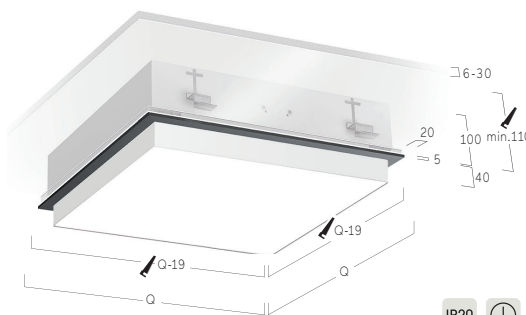

Ambient Diffuser | Direct

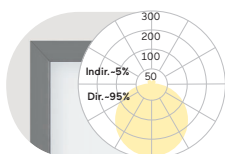

Q mm	Colour Temperature	Control	Power	Lumen/Watt	Weight kg	Code Snow White	Code Silver Anodised	CHF
379	4000K	On/Off	Medium	1310lm/12W	4,6	CM7FWE-840M-Q379	CM7FEE-840M-Q379	541,00
379	4000K	On/Off	High	1930lm/18W	4,6	CM7FWE-840H-Q379	CM7FEE-840H-Q379	541,00
479	4000K	On/Off	Medium	2140lm/19W	6,3	CM7FWE-840M-Q479	CM7FEE-840M-Q479	639,00
479	4000K	On/Off	High	3110lm/27W	6,3	CM7FWE-840H-Q479	CM7FEE-840H-Q479	639,00
621	4000K	On/Off	Medium	4870lm/40W	10,0	CM7FWE-840M-Q621	CM7FEE-840M-Q621	919,00
621	4000K	On/Off	High	7720lm/65W	10,0	CM7FWE-840H-Q621	CM7FEE-840H-Q621	919,00

Surcharges

Surface Finish	CHF	Control Gear	CHF	CHF	Colour Rendering	CHF	Colour Temperature	CHF	Additional Options	CHF
W: Snow White	✓	E: On/Off	Q379-Q621	Q910	8: CRI>80	✓	22: 2200K	+5%	Emergency Module [DALI, Autotest, incl. 3H Battery]	+366,00
E: Silver Anodised	✓	H: Touch-Dim	+86,00	+172,00	9: CRI>90	+5%	27: 2700K	+5%		
U: Urban Graphite	✓	L: DALI	+86,00	+172,00	F: Full Spectrum	+15%	30: 3000K	✓		
B: Jet Black	✓	6: DALI DT6 for TW	+172,00	+343,00			35: 3500K	+5%		
H: Anodic Champagne	+10%	8: DALI DT8 for TW	+172,00	+343,00			40: 4000K	✓		
R: Special RAL/NCS Colours	ⓘ	C: Casambi*	+261,00	+261,00			65: 6500K	+5%		
							TW: Tunable White 2700-6500K*	+30%		

*Only in combination with DALI. Please add to dimming price.

*Only in combination with DT6, DT8 or Casambi control. Please add additional control price.

✓ standard / no extra charge ⓘ on request ✗ not available

Cubic Déco L3 | Recessed Frame

catalogue page 486

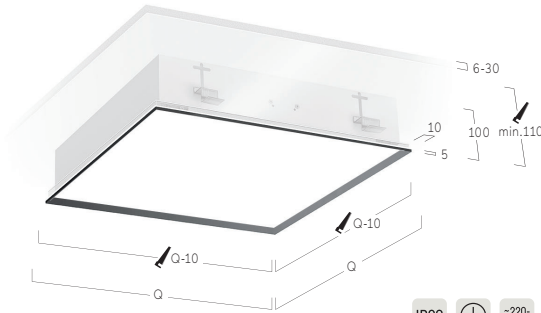

Microprismatic | Direct

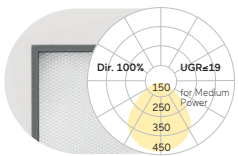

Q mm	Colour Temperature	Control	Power	Lumen/Watt	Weight kg	Code Snow White	Code Radiant Silver	CHF
350	4000K	On/Off	Medium	1360lm/12W	4,7	CL3AWE-840M-Q350-W	CL3ASE-840M-Q350-S	683,00
350	4000K	On/Off	High	2010lm/18W	4,7	CL3AWE-840H-Q350-W	CL3ASE-840H-Q350-S	683,00
450	4000K	On/Off	Medium	2370lm/19W	7,2	CL3AWE-840M-Q450-W	CL3ASE-840M-Q450-S	791,00
450	4000K	On/Off	High	3450lm/27W	7,2	CL3AWE-840H-Q450-W	CL3ASE-840H-Q450-S	791,00
550	4000K	On/Off	Medium	3630lm/27W	10,0	CL3AWE-840M-Q550-W	CL3ASE-840M-Q550-S	956,00
550	4000K	On/Off	High	6790lm/50W	10,0	CL3AWE-840H-Q550-W	CL3ASE-840H-Q550-S	956,00
650	4000K	On/Off	Medium	5200lm/40W	14,4	CL3AWE-840M-Q650-W	CL3ASE-840M-Q650-S	1101,00
650	4000K	On/Off	High	8500lm/65W	14,4	CL3AWE-840H-Q650-W	CL3ASE-840H-Q650-S	1101,00

Opal Diffuser | Direct

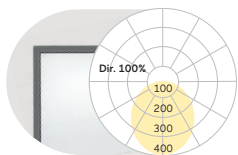

Q mm	Colour Temperature	Control	Power	Lumen/Watt	Weight kg	Code Snow White	Code Radiant Silver	CHF
350	4000K	On/Off	Medium	1400lm/12W	4,7	CL3OWE-840M-Q350-W	CL3OSE-840M-Q350-S	590,00
350	4000K	On/Off	High	2070lm/18W	4,7	CL3OWE-840H-Q350-W	CL3OSE-840H-Q350-S	590,00
450	4000K	On/Off	Medium	2440lm/19W	7,2	CL3OWE-840M-Q450-W	CL3OSE-840M-Q450-S	700,00
450	4000K	On/Off	High	3550lm/27W	7,2	CL3OWE-840H-Q450-W	CL3OSE-840H-Q450-S	700,00
550	4000K	On/Off	Medium	3740lm/27W	10,0	CL3OWE-840M-Q550-W	CL3OSE-840M-Q550-S	902,00
550	4000K	On/Off	High	6990lm/50W	10,0	CL3OWE-840H-Q550-W	CL3OSE-840H-Q550-S	902,00
650	4000K	On/Off	Medium	5360lm/40W	14,4	CL3OWE-840M-Q650-W	CL3OSE-840M-Q650-S	1045,00
650	4000K	On/Off	High	8760lm/65W	14,4	CL3OWE-840H-Q650-W	CL3OSE-840H-Q650-S	1045,00

Surcharges

Surface / Reflector Finish

Uni-Colours

W...W: Snow White / Snow White	✓	CHF
V...V: Ivory White / Ivory White	✓	CHF
S...S: Radiant Silver / Radiant Silver	✓	CHF
U...U: Urban Graphite / Urban Graphite	✓	CHF
B...B: Jet Black / Jet Black	✓	CHF
H...H: Anodic Champ. / Anodic Champ.	+5%	CHF
K...K: Satin Copper / Satin Copper	+15%	CHF

Surface / Reflector Finish

Dual Colours

W...G: Snow White / Satin Gold	+15%	CHF
W...K: Snow White / Satin Copper	+15%	CHF
W...B: Snow White / Jet Black	+15%	CHF
H...B: Anodic Champ./ Jet Black	+15%	CHF
B...G: Jet Black / Satin Gold	+15%	CHF
B...W: Jet Black / Snow White	+15%	CHF

Control Gear

CHF

E: On/Off	✓	CHF
L: DALI	+86,00	CHF
H: Touch-Dim	+86,00	CHF
C: Casambi*	+261,00	CHF
6: DALI DT6 for TW	+172,00	CHF
8: DALI DT8 for TW	+172,00	CHF

*Only in combination with DALI. Please add to dimming price.

Colour Rendering

CHF

8: CRI>80	✓	CHF
9: CRI>90	+5%	CHF
F: Full Spectrum	+15%	CHF

Colour Temperature

CHF

22: 2200K	+5%	CHF
27: 2700K	+5%	CHF
30: 3000K	✓	CHF
35: 3500K	+5%	CHF
40: 4000K	✓	CHF
65: 6500K	+5%	CHF
TW: Tunable White 2700-6500K*	+30%	CHF

*Only in combination with DT6, DT8 or Casambi control. Please add additional control price.

Additional Options

CHF

Radar Sensor	+209,00	CHF
Emergency Module [DALI, Autotest, incl. 3H Battery]	+366,00	CHF

✓ standard / no extra charge ⚠ on request ✗ not available

Matric Déco M9 | Recessed Frameless

catalogue page 488

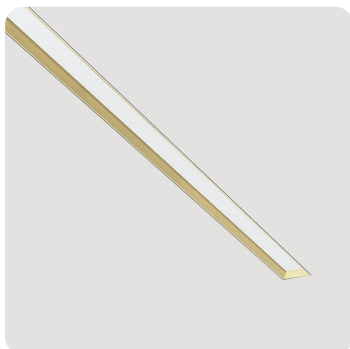

Installation Bracket without Shadow Gap

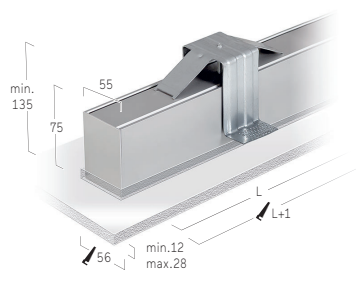

Installation Housing with Shadow Gap

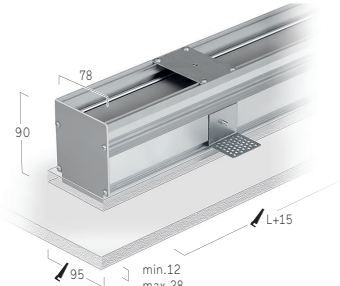

... Matric Déco M9 | Recessed Frameless

Lens Louvre | Direct

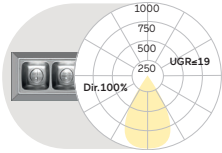

L mm	Colour Temperature	Control	Power	Lumen/Watt	Weight kg	Code Snow White/Snow White	CHF
681	4000K	On/Off	Low	1090lm/10W	2,5	LM9LWE-840E-L681-BW	674,00
681	4000K	On/Off	High	2000lm/17W	2,5	LM9LWE-840H-L681-BW	674,00
945	4000K	On/Off	Low	1520lm/13W	3,1	LM9LWE-840E-L945-BW	699,00
945	4000K	On/Off	High	2790lm/24W	3,1	LM9LWE-840H-L945-BW	699,00
1209	4000K	On/Off	Low	1960lm/16W	3,7	LM9LWE-840E-L1209-BW	804,00
1209	4000K	On/Off	High	3590lm/30W	3,7	LM9LWE-840H-L1209-BW	804,00
1474	4000K	On/Off	Low	2390lm/19W	4,4	LM9LWE-840E-L1474-BW	954,00
1474	4000K	On/Off	High	4390lm/37W	4,4	LM9LWE-840H-L1474-BW	954,00
1738	4000K	On/Off	Low	2830lm/23W	5,0	LM9LWE-840E-L1738-BW	1147,00
1738	4000K	On/Off	High	5190lm/43W	5,0	LM9LWE-840H-L1738-BW	1147,00
2002	4000K	On/Off	Low	3260lm/26W	5,9	LM9LWE-840E-L2002-BW	1383,00
2002	4000K	On/Off	High	5990lm/49W	5,9	LM9LWE-840H-L2002-BW	1383,00
per meter	4000K	On/Off	Low	1650lm/12,5W	3,3	LM9LWE-840E-L****-BW	683,00
per meter	4000K	On/Off	High	3020lm/24,1W	3,3	LM9LWE-840H-L****-BW	683,00
per meter	4000K	DALI	Low	1650lm/12,5W	3,3	LM9LWL-840E-L****-BW	735,00
per meter	4000K	DALI	High	3020lm/24,1W	3,3	LM9LWL-840H-L****-BW	735,00

Microprismatic | Direct

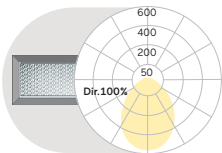

L mm	Colour Temperature	Control	Power	Lumen/Watt	Weight kg	Code Snow White/Snow White	CHF
600	4000K	On/Off	Low	550lm/7W	2,2	LM9AWE-840E-L600-BW	534,00
600	4000K	On/Off	High	990lm/12W	2,2	LM9AWE-840H-L600-BW	534,00
890	4000K	On/Off	Low	830lm/10W	2,8	LM9AWE-840E-L890-BW	559,00
890	4000K	On/Off	High	1490lm/16W	2,8	LM9AWE-840H-L890-BW	559,00
1182	4000K	On/Off	Low	1110lm/12W	3,5	LM9AWE-840E-L1182-BW	611,00
1182	4000K	On/Off	High	1990lm/21W	3,5	LM9AWE-840H-L1182-BW	611,00
1475	4000K	On/Off	Low	1390lm/14W	4,1	LM9AWE-840E-L1475-BW	709,00
1475	4000K	On/Off	High	2480lm/25W	4,1	LM9AWE-840H-L1475-BW	709,00
1765	4000K	On/Off	Low	1660lm/17W	4,8	LM9AWE-840E-L1765-BW	867,00
1765	4000K	On/Off	High	2980lm/30W	4,8	LM9AWE-840H-L1765-BW	867,00
2055	4000K	On/Off	Low	1940lm/22W	5,7	LM9AWE-840E-L2055-BW	1066,00
2055	4000K	On/Off	High	3480lm/37W	5,7	LM9AWE-840H-L2055-BW	1066,00
per meter	4000K	On/Off	Low	940lm/9,5W	3,1	LM9AWE-840E-L****-BW	517,00
per meter	4000K	On/Off	High	1690lm/16,9W	3,1	LM9AWE-840H-L****-BW	517,00
per meter	4000K	DALI	Low	940lm/9,5W	3,1	LM9AWL-840E-L****-BW	569,00
per meter	4000K	DALI	High	1690lm/16,9W	3,1	LM9AWL-840H-L****-BW	569,00

Opal Diffuser | Direct

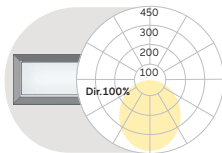

L mm	Colour Temperature	Control	Power	Lumen/Watt	Weight kg	Code Snow White/Snow White	CHF
600	4000K	On/Off	Medium	780lm/9W	2,2	LM9OWE-840M-L600-BW	517,00
600	4000K	On/Off	High	1060lm/12W	2,2	LM9OWE-840H-L600-BW	517,00
890	4000K	On/Off	Medium	1170lm/12W	2,8	LM9OWE-840M-L890-BW	541,00
890	4000K	On/Off	High	1590lm/16W	2,8	LM9OWE-840H-L890-BW	541,00
1182	4000K	On/Off	Medium	1560lm/15W	3,5	LM9OWE-840M-L1182-BW	587,00
1182	4000K	On/Off	High	2110lm/21W	3,5	LM9OWE-840H-L1182-BW	587,00
1475	4000K	On/Off	Medium	1950lm/19W	4,1	LM9OWE-840M-L1475-BW	674,00
1475	4000K	On/Off	High	2640lm/25W	4,1	LM9OWE-840H-L1475-BW	674,00
1765	4000K	On/Off	Medium	2330lm/22W	4,8	LM9OWE-840M-L1765-BW	821,00
1765	4000K	On/Off	High	3170lm/30W	4,8	LM9OWE-840H-L1765-BW	821,00
2055	4000K	On/Off	Medium	2720lm/28W	5,7	LM9OWE-840M-L2055-BW	996,00
2055	4000K	On/Off	High	3700lm/37W	5,7	LM9OWE-840H-L2055-BW	996,00
per meter	4000K	On/Off	Medium	1320lm/12,4W	3,1	LM9OWE-840M-L****-BW	482,00
per meter	4000K	On/Off	High	1800lm/16,9W	3,1	LM9OWE-840H-L****-BW	482,00
per meter	4000K	DALI	Medium	1320lm/12,4W	3,1	LM9OWL-840M-L****-BW	534,00
per meter	4000K	DALI	High	1800lm/16,9W	3,1	LM9OWL-840H-L****-BW	534,00

**** Your length in mm

Meterpreise für Lichtsysteme nach Maß ab Mindestlänge 2200mm | Prices per meter for customised lighting systems with a minimum length of 2200mm | Prix au mètre pour systèmes d'éclairage sur mesure à partir d'une longueur minimale de 2200mm

Surcharges

Control Gear

	CHF	CHF
	L600-L1765	L2055
E: On/Off	✓	✓
L: DALI	+86,00	+172,00
H: Touch-Dim	+86,00	+172,00
C: Casambi*	+261,00	+261,00
6: DALI DT6 for TW [L1182-L2055]	+172,00	+343,00
8: DALI DT8 for TW [L890-L2055]	+172,00	+343,00

*Only in combination with DALI. Please add to dimming price.

Colour Rendering

	CHF
8: CRI>80	✓
9: CRI>90	+5%
F: Full Spectrum	+15%

Colour Temperature

	CHF
22: 2200K	+5%
27: 2700K	+5%
30: 3000K	✓
35: 3500K	+5%
40: 4000K	✓
65: 6500K	+5%
TW: Tunable White 2700-6500K*	+30%

*Only in combination with DT6, DT8 or Casambi control. Please add additional control price.

Reflector Colour

	CHF
W: Snow White/Snow White	+15%
A: Satin Silver/Satin Silver	+15%
B: Jet Black/Jet Black	+15%
H: Anodic Champ./Anodic Champ.	+15%
K: Satin Copper/ Satin Copper	+15%
G: Satin Gold/ Satin Gold	+15%

Installation

	CHF
B: Installation Brackets	✓
F: Installation Housing	+20%

Additional Options

	CHF
Emergency Module [DALI, Autotest, incl. 3H Battery] [L1182-L2055]	+366,00

✓ standard / no extra charge ⚠ on request ✗ not available

Matric Déco F9 | Recessed Frame

catalogue page 490

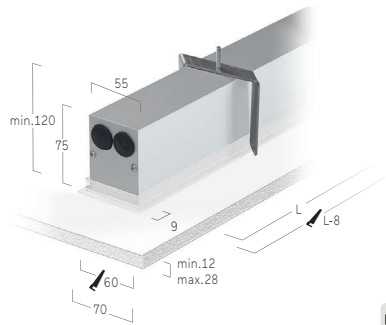
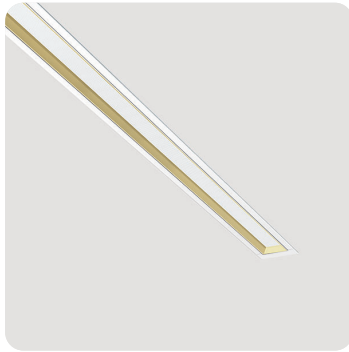

Lens Louvre | Direct

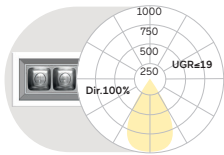

L mm	Colour Temperature	Control	Power	Lumen/Watt	Weight kg	Code Snow White/Snow White	Code Jet Black/Jet Black	CHF
696	4000K	On/Off	Low	1090lm/10W	2,3	LF9LWE-840E-L696-W	LF9LBE-840E-L696-B	683,00
696	4000K	On/Off	High	2000lm/17W	2,3	LF9LWE-840H-L696-W	LF9LBE-840H-L696-B	683,00
960	4000K	On/Off	Low	1520lm/13W	2,9	LF9LWE-840E-L960-W	LF9LBE-840E-L960-B	707,00
960	4000K	On/Off	High	2790lm/24W	2,9	LF9LWE-840H-L960-W	LF9LBE-840H-L960-B	707,00
1224	4000K	On/Off	Low	1960lm/16W	3,6	LF9LWE-840E-L1224-W	LF9LBE-840E-L1224-B	812,00
1224	4000K	On/Off	High	3590lm/30W	3,6	LF9LWE-840H-L1224-W	LF9LBE-840H-L1224-B	812,00
1489	4000K	On/Off	Low	2390lm/19W	4,3	LF9LWE-840E-L1489-W	LF9LBE-840E-L1489-B	963,00
1489	4000K	On/Off	High	4390lm/37W	4,3	LF9LWE-840H-L1489-W	LF9LBE-840H-L1489-B	963,00
1753	4000K	On/Off	Low	2830lm/23W	4,9	LF9LWE-840E-L1753-W	LF9LBE-840E-L1753-B	1155,00
1753	4000K	On/Off	High	5190lm/43W	4,9	LF9LWE-840H-L1753-W	LF9LBE-840H-L1753-B	1155,00
2017	4000K	On/Off	Low	3260lm/26W	5,9	LF9LWE-840E-L2017-W	LF9LBE-840E-L2017-B	1392,00
2017	4000K	On/Off	High	5990lm/49W	5,9	LF9LWE-840H-L2017-W	LF9LBE-840H-L2017-B	1392,00
per meter	4000K	On/Off	Low	1650lm/12,5W	3,0	LF9LWE-840E-L****-W	LF9LBE-840E-L****-B	692,00
per meter	4000K	On/Off	High	3020lm/24,1W	3,0	LF9LWE-840H-L****-W	LF9LBE-840H-L****-B	692,00
per meter	4000K	DALI	Low	1650lm/12,5W	3,0	LF9LWL-840E-L****-W	LF9LBL-840E-L****-B	744,00
per meter	4000K	DALI	High	3020lm/24,1W	3,0	LF9LWL-840H-L****-W	LF9LBL-840H-L****-B	744,00

Microprismatic | Direct

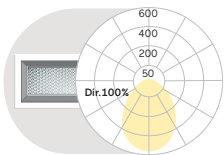

L mm	Colour Temperature	Control	Power	Lumen/Watt	Weight kg	Code Snow White/Snow White	Code Jet Black/Jet Black	CHF
615	4000K	On/Off	Low	550lm/7W	2,0	LF9AWE-840E-L615-W	LF9ABE-840E-L615-B	543,00
615	4000K	On/Off	High	990lm/12W	2,0	LF9AWE-840H-L615-W	LF9ABE-840H-L615-B	543,00
905	4000K	On/Off	Low	830lm/10W	2,7	LF9AWE-840E-L905-W	LF9ABE-840E-L905-B	567,00
905	4000K	On/Off	High	1490lm/16W	2,7	LF9AWE-840H-L905-W	LF9ABE-840H-L905-B	567,00
1198	4000K	On/Off	Low	1110lm/12W	3,4	LF9AWE-840E-L1198-W	LF9ABE-840E-L1198-B	620,00
1198	4000K	On/Off	High	1990lm/21W	3,4	LF9AWE-840H-L1198-W	LF9ABE-840H-L1198-B	620,00
1490	4000K	On/Off	Low	1390lm/14W	4,0	LF9AWE-840E-L1490-W	LF9ABE-840E-L1490-B	718,00
1490	4000K	On/Off	High	2480lm/25W	4,0	LF9AWE-840H-L1490-W	LF9ABE-840H-L1490-B	718,00
1780	4000K	On/Off	Low	1660lm/17W	4,7	LF9AWE-840E-L1780-W	LF9ABE-840E-L1780-B	875,00
1780	4000K	On/Off	High	2980lm/30W	4,7	LF9AWE-840H-L1780-W	LF9ABE-840H-L1780-B	875,00
2075	4000K	On/Off	Low	1940lm/22W	5,7	LF9AWE-840E-L2075-W	LF9ABE-840E-L2075-B	1075,00
2075	4000K	On/Off	High	3480lm/37W	5,7	LF9AWE-840H-L2075-W	LF9ABE-840H-L2075-B	1075,00
per meter	4000K	On/Off	Low	940lm/9,5W	2,9	LF9AWE-840E-L****-W	LF9ABE-840E-L****-B	525,00
per meter	4000K	On/Off	High	1690lm/16,9W	2,9	LF9AWE-840H-L****-W	LF9ABE-840H-L****-B	525,00
per meter	4000K	DALI	Low	940lm/9,5W	2,9	LF9AWL-840E-L****-W	LF9ABL-840E-L****-B	578,00
per meter	4000K	DALI	High	1690lm/16,9W	2,9	LF9AWL-840H-L****-W	LF9ABL-840H-L****-B	578,00

Opal Diffuser | Direct

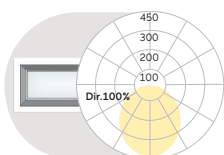

L mm	Colour Temperature	Control	Power	Lumen/Watt	Weight kg	Code Snow White/Snow White	Code Jet Black/Jet Black	CHF
615	4000K	On/Off	Medium	780lm/9W	2,0	LF9OWE-840M-L615-W	LF9OBE-840M-L615-B	525,00
615	4000K	On/Off	High	1060lm/12W	2,0	LF9OWE-840H-L615-W	LF9OBE-840H-L615-B	525,00
905	4000K	On/Off	Medium	1170lm/12W	2,7	LF9OWE-840M-L905-W	LF9OBE-840M-L905-B	550,00
905	4000K	On/Off	High	1590lm/16W	2,7	LF9OWE-840H-L905-W	LF9OBE-840H-L905-B	550,00
1198	4000K	On/Off	Medium	1560lm/15W	3,4	LF9OWE-840M-L1198-W	LF9OBE-840M-L1198-B	595,00
1198	4000K	On/Off	High	2110lm/21W	3,4	LF9OWE-840H-L1198-W	LF9OBE-840H-L1198-B	595,00
1490	4000K	On/Off	Medium	1950lm/19W	4,0	LF9OWE-840M-L1490-W	LF9OBE-840M-L1490-B	683,00
1490	4000K	On/Off	High	2640lm/25W	4,0	LF9OWE-840H-L1490-W	LF9OBE-840H-L1490-B	683,00
1780	4000K	On/Off	Medium	2330lm/22W	4,7	LF9OWE-840M-L1780-W	LF9OBE-840M-L1780-B	830,00
1780	4000K	On/Off	High	3170lm/30W	4,7	LF9OWE-840H-L1780-W	LF9OBE-840H-L1780-B	830,00
2075	4000K	On/Off	Medium	2720lm/28W	5,7	LF9OWE-840M-L2075-W	LF9OBE-840M-L2075-B	1005,00
2075	4000K	On/Off	High	3700lm/37W	5,7	LF9OWE-840H-L2075-W	LF9OBE-840H-L2075-B	1005,00
per meter	4000K	On/Off	Medium	1320lm/12,4W	2,9	LF9OWE-840M-L****-W	LF9OBE-840M-L****-B	490,00
per meter	4000K	On/Off	High	1800lm/16,9W	2,9	LF9OWE-840H-L****-W	LF9OBE-840H-L****-B	490,00
per meter	4000K	DALI	Medium	1320lm/12,4W	2,9	LF9OWL-840M-L****-W	LF9OBL-840M-L****-B	543,00
per meter	4000K	DALI	High	1800lm/16,9W	2,9	LF9OWL-840H-L****-W	LF9OBL-840H-L****-B	543,00

**** Your length in mm

Meterpreise für Lichtsysteme nach Maß ab Mindestlänge 2200mm | Prices per metre for customised lighting systems with a minimum length of 2200mm
 Prix au mètre pour systèmes d'éclairage sur mesure à partir d'une longueur minimale de 2200mm

Surcharges

Surface / Reflector Finish + Lens Louvre*	CHF
Uni-Colours	
W...W: Snow White / Snow White	✓
V...V: Ivory White / Ivory White	✓
A...A: Satin Silver / Satin Silver	✓
U...U: Urban Graphite / Urban Graphite	✓
B...B: Jet Black / Jet Black	✓
H...H: Anodic Champ. / Anodic Champ.	+10%
K...K: Satin Copper / Satin Copper	+15%

Surface / Reflector Finish + Lens Louvre*	CHF
Dual Colours	
W...G: Snow White / Satin Gold	+15%
W...K: Snow White / Satin Copper	+15%
W...B: Snow White / Jet Black	+15%
H...B: Anodic Champagne / Jet Black	+15%
B...G: Jet Black / Satin Gold	+15%
B...W: Jet Black / Snow White	+15%

Colour Rendering	CHF
8: CRI>80	✓
9: CRI>90	+5%
F: Full Spectrum	+15%

Control Gear	CHF	CHF
	L615-L1780	L2075
E: On/Off	✓	✓
L: DALI	+86,00	+172,00
H: Touch-Dim	+86,00	+172,00
C: Casambi* [L905-L2075]	+261,00	+261,00
6: DALI DT6 for TW [L1198-L2075]	+172,00	+343,00
8: DALI DT8 for TW [L905-L2075]	+172,00	+343,00

*Only in combination with DALI. Please add to dimming price.

Colour Temperature	CHF
22: 2200K	+5%
27: 2700K	+5%
30: 3000K	✓
35: 3500K	+5%
40: 4000K	✓
65: 6500K	+5%
TW: Tunable White 2700-6500K*	+30%

*Only in combination with DT6, DT8 or Casambi control. Please add additional control price.

Additional Options	CHF
Emergency Module [DALI, Autotest, incl. 3H Battery] [L1178-L2075]	+366,00

✓ standard / no extra charge ⚡ on request ✗ not available

Matric MX | System 40 mm Recessed Frameless

catalogue page **498**



Installation Housing with Shadow Gap

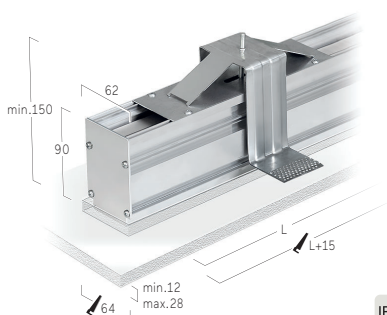

IP20 ⚡ -220/-240V 50-60 Hz IK 02 R60 ≤3 McAdam LOW POWER 190810 50000K MEDIUM POWER 185810 50000K HIGH POWER 180810 50000K CE UK CA

Lens Louvre | Direct

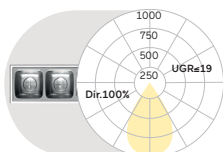

L mm	Colour Temperature	Control	Power	Lumen/Watt	Weight kg	Code Snow White/Jet Black	CHF
665	4000K	On/Off	Low	1090lm/10W	3,1	LMXLWE-840E-L665-B*	609,00
665	4000K	On/Off	High	2000lm/17W	3,1	LMXLWE-840H-L665-B*	609,00
930	4000K	On/Off	Low	1520lm/13W	4,1	LMXLWE-840E-L930-B*	637,00
930	4000K	On/Off	High	2790lm/24W	4,1	LMXLWE-840H-L930-B*	637,00
1194	4000K	On/Off	Low	1960lm/16W	5,2	LMXLWE-840E-L1194-B*	742,00
1194	4000K	On/Off	High	3590lm/30W	5,2	LMXLWE-840H-L1194-B*	742,00
1458	4000K	On/Off	Low	2390lm/19W	6,3	LMXLWE-840E-L1458-B*	900,00
1458	4000K	On/Off	High	4390lm/37W	6,3	LMXLWE-840H-L1458-B*	900,00
1723	4000K	On/Off	Low	2830lm/23W	7,3	LMXLWE-840E-L1723-B*	1103,00
1723	4000K	On/Off	High	5190lm/43W	7,3	LMXLWE-840H-L1723-B*	1103,00
1987	4000K	On/Off	Low	3260lm/26W	8,6	LMXLWE-840E-L1987-B*	1348,00
1987	4000K	On/Off	High	5990lm/49W	8,6	LMXLWE-840H-L1987-B*	1348,00
per meter	4000K	On/Off	Low	1650lm/12,5W	4,7	LMXLWE-840E-L****-B*	657,00
per meter	4000K	On/Off	High	3020lm/24,1W	4,7	LMXLWE-840H-L****-B*	657,00
per meter	4000K	DALI	Low	1650lm/12,5W	4,7	LMXLWL-840E-L****-B*	709,00
per meter	4000K	DALI	High	3020lm/24,1W	4,7	LMXLWL-840H-L****-B*	709,00

Microprismatic | Direct

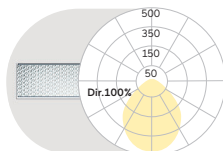

L mm	Colour Temperature	Control	Power	Lumen/Watt	Weight kg	Code Snow White	CHF
600	4000K	On/Off	Low	610lm/7W	2,8	LMXAW-E-840E-L600	506,00
600	4000K	On/Off	High	1100lm/12W	2,8	LMXAW-E-840H-L600	506,00
890	4000K	On/Off	Low	920lm/10W	3,9	LMXAW-E-840E-L890	532,00
890	4000K	On/Off	High	1650lm/16W	3,9	LMXAW-E-840H-L890	532,00
1182	4000K	On/Off	Low	1230lm/12W	5,1	LMXAW-E-840E-L1182	595,00
1182	4000K	On/Off	High	2200lm/21W	5,1	LMXAW-E-840H-L1182	595,00
1475	4000K	On/Off	Low	1530lm/14W	6,3	LMXAW-E-840E-L1475	700,00
1475	4000K	On/Off	High	2750lm/25W	6,3	LMXAW-E-840H-L1475	700,00
1765	4000K	On/Off	Low	1840lm/17W	7,4	LMXAW-E-840E-L1765	865,00
1765	4000K	On/Off	High	3300lm/30W	7,4	LMXAW-E-840H-L1765	865,00
2055	4000K	On/Off	Low	2150lm/22W	8,9	LMXAW-E-840E-L2055	1050,00
2055	4000K	On/Off	High	3850lm/37W	8,9	LMXAW-E-840H-L2055	1050,00
per meter	4000K	On/Off	Low	1040lm/9,5W	4,4	LMXAW-E-840E-L****	508,00
per meter	4000K	On/Off	High	1870lm/16,9W	4,4	LMXAW-E-840H-L****	508,00
per meter	4000K	DALI	Low	1040lm/9,5W	4,4	LMXAWL-840E-L****	560,00
per meter	4000K	DALI	High	1870lm/16,9W	4,4	LMXAWL-840H-L****	560,00

**** Your length in mm
 Meterpreise für Lichtsysteme nach Maß ab Mindestlänge 2200mm | Prices per meter for customised lighting systems with a minimum length of 2200mm | Prix au mètre pour systèmes d'éclairage sur mesure à partir d'une longueur minimale de 2200mm

Opal Diffuser | Direct

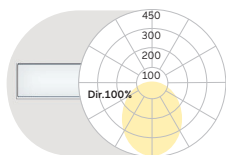

L mm	Colour Temperature	Control	Power	Lumen/Watt	Weight kg	Code Snow White	CHF
600	4000K	On/Off	Medium	870lm/9W	2,8	LMXOWE-840M-L600	489,00
600	4000K	On/Off	High	1180lm/12W	2,8	LMXOWE-840H-L600	489,00
890	4000K	On/Off	Medium	1300lm/12W	3,9	LMXOWE-840M-L890	515,00
890	4000K	On/Off	High	1760lm/16W	3,9	LMXOWE-840H-L890	515,00
1182	4000K	On/Off	Medium	1730lm/15W	5,1	LMXOWE-840M-L1182	567,00
1182	4000K	On/Off	High	2350lm/21W	5,1	LMXOWE-840H-L1182	567,00
1475	4000K	On/Off	Medium	2160lm/19W	6,3	LMXOWE-840M-L1475	665,00
1475	4000K	On/Off	High	2940lm/25W	6,3	LMXOWE-840H-L1475	665,00
1765	4000K	On/Off	Medium	2600lm/22W	7,4	LMXOWE-840M-L1765	812,00
1765	4000K	On/Off	High	3530lm/30W	7,4	LMXOWE-840H-L1765	812,00
2055	4000K	On/Off	Medium	3030lm/28W	8,9	LMXOWE-840M-L2055	987,00
2055	4000K	On/Off	High	4110lm/37W	8,9	LMXOWE-840H-L2055	987,00
per meter	4000K	On/Off	Medium	1470lm/12,4W	4,4	LMXOWE-840M-L****	482,00
per meter	4000K	On/Off	High	2000lm/16,9W	4,4	LMXOWE-840H-L****	482,00
per meter	4000K	DALI	Medium	1470lm/12,4W	4,4	LMXOWL-840M-L****	534,00
per meter	4000K	DALI	High	2000lm/16,9W	4,4	LMXOWL-840H-L****	534,00

Wallwasher | Direct

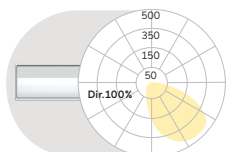

L mm	Colour Temperature	Control	Power	Lumen/Watt	Weight kg	Code Snow White	CHF
600	4000K	On/Off	Medium	840lm/11W	2,8	LMXGWE-840M-L600	541,00
600	4000K	On/Off	High	1070lm/14W	2,8	LMXGWE-840H-L600	541,00
890	4000K	On/Off	Medium	1260lm/15W	3,9	LMXGWE-840M-L890	569,00
890	4000K	On/Off	High	1610lm/19W	3,9	LMXGWE-840H-L890	569,00
1182	4000K	On/Off	Medium	1680lm/19W	5,1	LMXGWE-840M-L1182	651,00
1182	4000K	On/Off	High	2150lm/25W	5,1	LMXGWE-840H-L1182	651,00
1475	4000K	On/Off	Medium	2100lm/23W	6,3	LMXGWE-840M-L1475	749,00
1475	4000K	On/Off	High	2680lm/30W	6,3	LMXGWE-840H-L1475	749,00
1765	4000K	On/Off	Medium	2520lm/28W	7,4	LMXGWE-840M-L1765	888,00
1765	4000K	On/Off	High	3220lm/36W	7,4	LMXGWE-840H-L1765	888,00
2055	4000K	On/Off	Medium	2940lm/34W	8,9	LMXGWE-840M-L2055	1112,00
2055	4000K	On/Off	High	3760lm/44W	8,9	LMXGWE-840H-L2055	1112,00
per meter	4000K	On/Off	Medium	1430lm/15,6W	4,4	LMXGWE-840M-L****	525,00
per meter	4000K	On/Off	High	1830lm/20,3W	4,4	LMXGWE-840H-L****	525,00
per meter	4000K	DALI	Medium	1430lm/15,6W	4,4	LMXGWL-840M-L****	578,00
per meter	4000K	DALI	High	1830lm/20,3W	4,4	LMXGWL-840H-L****	578,00

**** Your length in mm

Meterpreise für Lichtsysteme nach Maß ab Mindestlänge 2200mm | Prices per meter for customised lighting systems with a minimum length of 2200mm | Prix au mètre pour systèmes d'éclairage sur mesure à partir d'une longueur minimale de 2200mm



90° Corner
Opal/Micropismatic

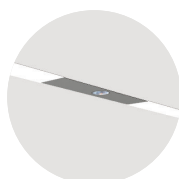

Midpin-Downlight XD
310lm/5W/Ø21mm

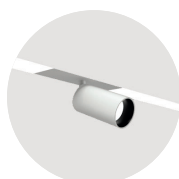

Midpin Spotlight XM
770lm/10W/Ø40mm



3-Phase Track



48V Track

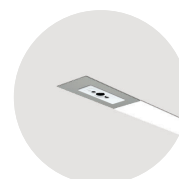

Multisensor

Surcharges

Control Gear

	CHF L600-L1765	CHF L2055
E: On/Off	✓	✓
L: DALI	+86,00	+172,00
H: Touch-Dim	+86,00	+172,00
C: Casambi* [L890-L2055]	+261,00	+261,00
6: DALI DT6 for TW [L1182-L2055]	+172,00	+343,00
8: DALI DT8 for TW [L890-L2055]	+172,00	+343,00

*Only in combination with DALI. Please add to dimming price.

Colour Temperature

Colour Temperature	CHF
22: 2200K	+5%
27: 2700K	+5%
30: 3000K	✓
35: 3500K	+5%
40: 4000K	✓
65: 6500K	+5%
TW: Tunable White 2700-6500K*	+30%

*Only in combination with DT6, DT8 or Casambi control. Please add additional control price.

Colour Rendering

Colour Rendering	CHF
8: CRI>80	✓
9: CRI>90	+5%
F: Full Spectrum	+15%
Lens Louvre*	CHF
W: Snow White	✓
A: Satin Silver	✓
B: Jet Black	✓
H: Anodic Champagne	✓
K: Satin Copper	✓
G: Satin Gold	✓

Additional Options

Additional Options	CHF
90° Corner	ⓘ
Midpin Downlight XD	+363,00
Midpin Spotlight XM	+363,00
3-Phase Track	ⓘ
48V Track	ⓘ
Multisensor [L1182-L2055]	+261,00
Emergency Module [DALI, Autotest, incl. 3H Battery] [L1182-L2055]	+366,00

✓ standard / no extra charge ⓘ on request ✗ not available

Matric FX | System 40mm Recessed Frame

catalogue page 500

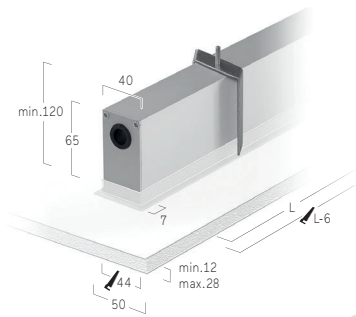
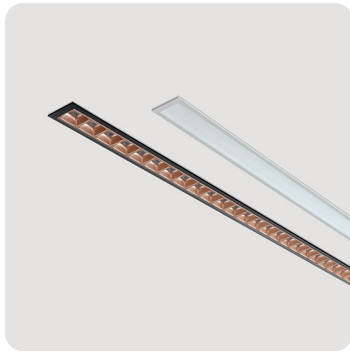

Lens Louvre | Direct

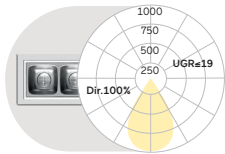

L mm	Colour Temperature	Control	Power	Lumen/Watt	Weight kg	Code Snow White/Jet Black	Code Silver Anodised/Jet Black	CHF
675	4000K	On/Off	Low	1090lm/10W	1,6	LFXLWE-840E-L675-B*	LFXLEE-840E-L675-B*	601,00
675	4000K	On/Off	High	2000lm/17W	1,6	LFXLWE-840H-L675-B*	LFXLEE-840H-L675-B*	601,00
940	4000K	On/Off	Low	1520lm/13W	2,0	LFXLWE-840E-L940-B*	LFXLEE-840E-L940-B*	620,00
940	4000K	On/Off	High	2790lm/24W	2,0	LFXLWE-840H-L940-B*	LFXLEE-840H-L940-B*	620,00
1204	4000K	On/Off	Low	1960lm/16W	2,5	LFXLWE-840E-L1204-B*	LFXLEE-840E-L1204-B*	690,00
1204	4000K	On/Off	High	3590lm/30W	2,5	LFXLWE-840H-L1204-B*	LFXLEE-840H-L1204-B*	690,00
1468	4000K	On/Off	Low	2390lm/19W	2,9	LFXLWE-840E-L1468-B*	LFXLEE-840E-L1468-B*	812,00
1468	4000K	On/Off	High	4390lm/37W	2,9	LFXLWE-840H-L1468-B*	LFXLEE-840H-L1468-B*	812,00
1733	4000K	On/Off	Low	2830lm/23W	3,4	LFXLWE-840E-L1733-B*	LFXLEE-840E-L1733-B*	980,00
1733	4000K	On/Off	High	5190lm/43W	3,4	LFXLWE-840H-L1733-B*	LFXLEE-840H-L1733-B*	980,00
1997	4000K	On/Off	Low	3260lm/26W	4,2	LFXLWE-840E-L1997-B*	LFXLEE-840E-L1997-B*	1190,00
1997	4000K	On/Off	High	5990lm/49W	4,2	LFXLWE-840H-L1997-B*	LFXLEE-840H-L1997-B*	1190,00
per meter	4000K	On/Off	Low	1650lm/12,5W	2,1	LFXLWE-840E-L****-B*	LFXLEE-840E-L****-B*	587,00
per meter	4000K	On/Off	High	3020lm/24,1W	2,1	LFXLWE-840H-L****-B*	LFXLEE-840H-L****-B*	587,00
per meter	4000K	DALI	Low	1650lm/12,5W	2,1	LFXLWL-840E-L****-B*	LFXLEEL-840E-L****-B*	639,00
per meter	4000K	DALI	High	3020lm/24,1W	2,1	LFXLWL-840H-L****-B*	LFXLEEL-840H-L****-B*	639,00

Microprismatic | Direct

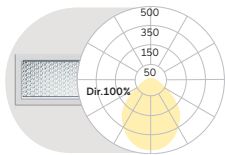

L mm	Colour Temperature	Control	Power	Lumen/Watt	Weight kg	Code Snow White	Code Silver Anodised	CHF
610	4000K	On/Off	Low	610lm/7W	1,7	LFXAWWE-840E-L610	LFXAAEE-840E-L610	497,00
610	4000K	On/Off	High	1100lm/12W	1,7	LFXAWWE-840H-L610	LFXAAEE-840H-L610	497,00
900	4000K	On/Off	Low	920lm/10W	2,0	LFXAWWE-840E-L900	LFXAAEE-840E-L900	515,00
900	4000K	On/Off	High	1650lm/16W	2,0	LFXAWWE-840H-L900	LFXAAEE-840H-L900	515,00
1192	4000K	On/Off	Low	1230lm/12W	2,5	LFXAWWE-840E-L1192	LFXAAEE-840E-L1192	543,00
1192	4000K	On/Off	High	2200lm/21W	2,5	LFXAWWE-840H-L1192	LFXAAEE-840H-L1192	543,00
1485	4000K	On/Off	Low	1530lm/14W	3,0	LFXAWWE-840E-L1485	LFXAAEE-840E-L1485	613,00
1485	4000K	On/Off	High	2750lm/25W	3,0	LFXAWWE-840H-L1485	LFXAAEE-840H-L1485	613,00
1775	4000K	On/Off	Low	1840lm/17W	3,5	LFXAWWE-840E-L1775	LFXAAEE-840E-L1775	742,00
1775	4000K	On/Off	High	3300lm/30W	3,5	LFXAWWE-840H-L1775	LFXAAEE-840H-L1775	742,00
2065	4000K	On/Off	Low	2150lm/22W	4,4	LFXAWWE-840E-L2065	LFXAAEE-840E-L2065	893,00
2065	4000K	On/Off	High	3850lm/37W	4,4	LFXAWWE-840H-L2065	LFXAAEE-840H-L2065	893,00
per meter	4000K	On/Off	Low	1040lm/9,5W	2,2	LFXAWWE-840E-L****	LFXAAEE-840E-L****	438,00
per meter	4000K	On/Off	High	1870lm/16,9W	2,2	LFXAWWE-840H-L****	LFXAAEE-840H-L****	438,00
per meter	4000K	DALI	Low	1040lm/9,5W	2,2	LFXAWWL-840E-L****	LFXAAEL-840E-L****	490,00
per meter	4000K	DALI	High	1870lm/16,9W	2,2	LFXAWWL-840H-L****	LFXAAEL-840H-L****	490,00

Opal Diffuser | Direct

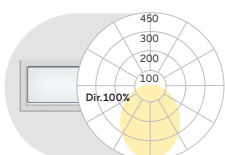

L mm	Colour Temperature	Control	Power	Lumen/Watt	Weight kg	Code Snow White	Code Silver Anodised	CHF
610	4000K	On/Off	Medium	870lm/9W	1,7	LFXOWWE-840M-L610	LFXOOEE-840M-L610	480,00
610	4000K	On/Off	High	1180lm/12W	1,7	LFXOWWE-840H-L610	LFXOOEE-840H-L610	480,00
900	4000K	On/Off	Medium	1300lm/12W	2,0	LFXOWWE-840M-L900	LFXOOEE-840M-L900	497,00
900	4000K	On/Off	High	1760lm/16W	2,0	LFXOWWE-840H-L900	LFXOOEE-840H-L900	497,00
1192	4000K	On/Off	Medium	1730lm/15W	2,5	LFXOWWE-840M-L1192	LFXOOEE-840M-L1192	515,00
1192	4000K	On/Off	High	2350lm/21W	2,5	LFXOWWE-840H-L1192	LFXOOEE-840H-L1192	515,00
1485	4000K	On/Off	Medium	2160lm/19W	3,0	LFXOWWE-840M-L1485	LFXOOEE-840M-L1485	578,00
1485	4000K	On/Off	High	2940lm/25W	3,0	LFXOWWE-840H-L1485	LFXOOEE-840H-L1485	578,00
1775	4000K	On/Off	Medium	2600lm/22W	3,5	LFXOWWE-840M-L1775	LFXOOEE-840M-L1775	690,00
1775	4000K	On/Off	High	3530lm/30W	3,5	LFXOWWE-840H-L1775	LFXOOEE-840H-L1775	690,00
2065	4000K	On/Off	Medium	3030lm/28W	4,4	LFXOWWE-840M-L2065	LFXOOEE-840M-L2065	830,00
2065	4000K	On/Off	High	4110lm/37W	4,4	LFXOWWE-840H-L2065	LFXOOEE-840H-L2065	830,00
per meter	4000K	On/Off	Medium	1470lm/12,4W	2,2	LFXOWWE-840M-L****	LFXOOEE-840M-L****	412,00
per meter	4000K	On/Off	High	2000lm/16,9W	2,2	LFXOWWE-840H-L****	LFXOOEE-840H-L****	412,00
per meter	4000K	DALI	Medium	1470lm/12,4W	2,2	LFXOWWL-840M-L****	LFXOOEL-840M-L****	464,00
per meter	4000K	DALI	High	2000lm/16,9W	2,2	LFXOWWL-840H-L****	LFXOOEL-840H-L****	464,00

**** Your length in mm

Meterpreise für Lichtsysteme nach Maß ab Mindestlänge 2200mm | Prices per metre for customised lighting systems with a minimum length of 2200mm
 Prix au mètre pour systèmes d'éclairage sur mesure à partir d'une longueur minimale de 2200mm

Wallwasher | Direct

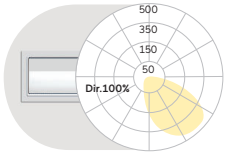

L mm	Colour Temperature	Control	Power	Lumen/Watt	Weight kg	Code Snow White	Code Silver Anodised	CHF
610	4000K	On/Off	Medium	840lm/11W	1,7	LFXGWE-840M-L610	LFXGEE-840M-L610	532,00
610	4000K	On/Off	High	1070lm/14W	1,7	LFXGWE-840H-L610	LFXGEE-840H-L610	532,00
900	4000K	On/Off	Medium	1260lm/15W	2,2	LFXGWE-840M-L900	LFXGEE-840M-L900	552,00
900	4000K	On/Off	High	1610lm/19W	2,2	LFXGWE-840H-L900	LFXGEE-840H-L900	552,00
1192	4000K	On/Off	Medium	1680lm/19W	2,7	LFXGWE-840M-L1192	LFXGEE-840M-L1192	599,00
1192	4000K	On/Off	High	2150lm/25W	2,7	LFXGWE-840H-L1192	LFXGEE-840H-L1192	599,00
1485	4000K	On/Off	Medium	2100lm/23W	3,3	LFXGWE-840M-L1485	LFXGEE-840M-L1485	662,00
1485	4000K	On/Off	High	2680lm/30W	3,3	LFXGWE-840H-L1485	LFXGEE-840H-L1485	662,00
1775	4000K	On/Off	Medium	2520lm/28W	3,8	LFXGWE-840M-L1775	LFXGEE-840M-L1775	765,00
1775	4000K	On/Off	High	3220lm/36W	3,8	LFXGWE-840H-L1775	LFXGEE-840H-L1775	765,00
2065	4000K	On/Off	Medium	2940lm/34W	4,5	LFXGWE-840M-L2065	LFXGEE-840M-L2065	954,00
2065	4000K	On/Off	High	3760lm/44W	4,5	LFXGWE-840H-L2065	LFXGEE-840H-L2065	954,00
per meter	4000K	On/Off	Medium	1430lm/15,6W	2,4	LFXGWE-840M-L****	LFXGEE-840M-L****	455,00
per meter	4000K	On/Off	High	1830lm/20,3W	2,4	LFXGWE-840H-L****	LFXGEE-840H-L****	455,00
per meter	4000K	DALI	Medium	1430lm/15,6W	2,4	LFXGWL-840M-L****	LFXGEL-840M-L****	508,00
per meter	4000K	DALI	High	1830lm/20,3W	2,4	LFXGWL-840H-L****	LFXGEL-840H-L****	508,00



90° Corner Opal/Micropismatic

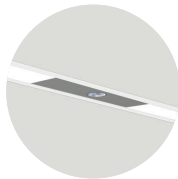

Midpin-Downlight XD 310lm/5W/Ø21mm

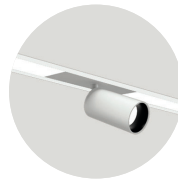

Midpin Spotlight XM 770lm/10W/Ø40mm

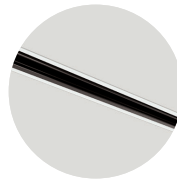

48V Track

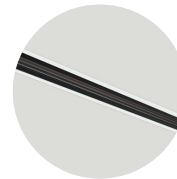

3-Phase Track



Multisensor

Surcharges

Surface Finish

Surface Finish	CHF
W: Snow White	✓
V: Ivory White	✓
A: Satin Silver	✓
E: Silver Anodised	✓
U: Urban Graphite	✓
B: Jet Black	✓
H: Anodic Champagne	+10%
K: Satin Copper	+15%
R: Special RAL/NCS Colours	ⓘ

Control Gear

Control Gear	CHF L610-L1775	CHF L2065
E: On/Off	✓	✓
L: DALI	+86,00	+172,00
H: Touch-Dim	+86,00	+172,00
C: Casambi* [L900-L2065]	+261,00	+261,00
6: DALI DT6 for TW [L1192-L2065]	+172,00	+343,00
8: DALI DT8 for TW [L900-L2065]	+172,00	+343,00

*Only in combination with DALI. Please add to dimming price.

Colour Temperature

Colour Temperature	CHF
22: 2200K	+5%
27: 2700K	+5%
30: 3000K	✓
35: 3500K	+5%
40: 4000K	✓
65: 6500K	+5%
TW: Tunable White 2700-6500K*	+30%

*Only in combination with DT6, DT8 or Casambi control. Please add additional control price.

Colour Rendering

Colour Rendering	CHF
8: CRI>80	✓
9: CRI>90	+5%
F: Full Spectrum	+15%

Lens Louvre*

Lens Louvre*	CHF
W: Snow White	✓
A: Satin Silver	✓
B: Jet Black	✓
H: Anodic Champagne	✓
K: Satin Copper	✓
G: Satin Gold	✓

Additional Options

Additional Options	CHF
90° Corner	ⓘ
Midpin Downlight XD	+363,00
Midpin Spotlight XM	+363,00
3-Phase Track	ⓘ
48V Track	ⓘ
Multisensor [L1192-L2065]	+261,00
Emergency Module [DALI, Autotest, incl. 3H Battery] [L1192-L2065]	+366,00

✓ standard / no extra charge ⓘ on request ✗ not available

Matric M3 | System 55mm Recessed Frameless

catalogue page 502

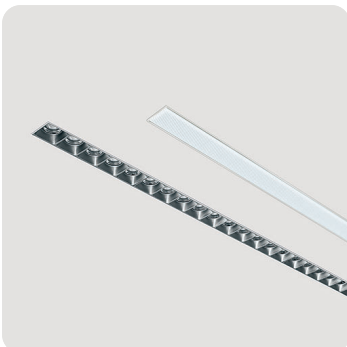

B: Installation Bracket without Shadow Gap

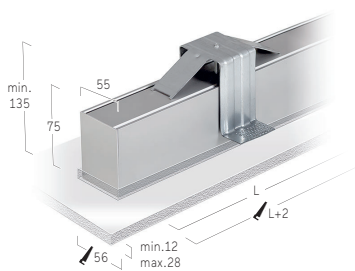

F: Installation Housing with Shadow Gap

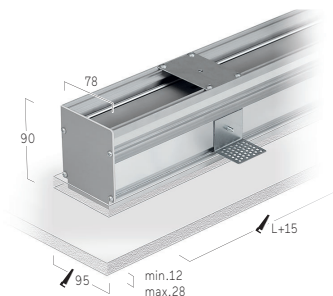

... Matric M3 | System 55mm Recessed Frameless

Lens Louvre | Direct

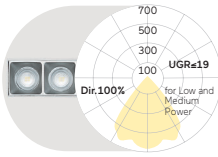

L mm	Colour Temperature	Control	Power	Lumen/Watt	Weight kg	Code	Snow White/Jet Black	CHF
752	4000K	On/Off	Low	1370lm/11W	2,6	LM3LWE-840E-L752-BB*		648,00
752	4000K	On/Off	Medium	1870lm/15W	2,6	LM3LWE-840M-L752-BB*		648,00
752	4000K	On/Off	High	2690lm/22W	2,6	LM3LWE-840H-L752-BB*		648,00
1002	4000K	On/Off	Low	1830lm/14W	3,2	LM3LWE-840E-L1002-BB*		664,00
1002	4000K	On/Off	Medium	2500lm/19W	3,2	LM3LWE-840M-L1002-BB*		664,00
1002	4000K	On/Off	High	3590lm/28W	3,2	LM3LWE-840H-L1002-BB*		664,00
1252	4000K	On/Off	Low	2290lm/16W	3,8	LM3LWE-840E-L1252-BB*		751,00
1252	4000K	On/Off	Medium	3120lm/23W	3,8	LM3LWE-840M-L1252-BB*		751,00
1252	4000K	On/Off	High	4500lm/34W	3,8	LM3LWE-840H-L1252-BB*		751,00
1502	4000K	On/Off	Low	2750lm/19W	4,3	LM3LWE-840E-L1502-BB*		884,00
1502	4000K	On/Off	Medium	3750lm/27W	4,3	LM3LWE-840M-L1502-BB*		884,00
1502	4000K	On/Off	High	5380lm/40W	4,3	LM3LWE-840H-L1502-BB*		884,00
1752	4000K	On/Off	Low	3200lm/22W	4,9	LM3LWE-840E-L1752-BB*		1059,00
1752	4000K	On/Off	Medium	4370lm/31W	4,9	LM3LWE-840M-L1752-BB*		1059,00
1752	4000K	On/Off	High	6280lm/46W	4,9	LM3LWE-840H-L1752-BB*		1059,00
2002	4000K	On/Off	Low	3660lm/25W	5,8	LM3LWE-840E-L2002-BB*		1278,00
2002	4000K	On/Off	Medium	5000lm/35W	5,8	LM3LWE-840M-L2002-BB*		1278,00
2002	4000K	On/Off	High	7180lm/53W	5,8	LM3LWE-840H-L2002-BB*		1278,00
per meter	4000K	On/Off	Low	1830lm/12,3W	3,2	LM3LWE-840E-L****-BB*		630,00
per meter	4000K	On/Off	Medium	2500lm/17,3W	3,2	LM3LWE-840M-L****-BB*		630,00
per meter	4000K	On/Off	High	3600lm/26,4W	3,2	LM3LWE-840H-L****-BB*		630,00
per meter	4000K	DALI	Low	1830lm/12,3W	3,2	LM3LWL-840E-L****-BB*		683,00
per meter	4000K	DALI	Medium	2500lm/17,3W	3,2	LM3LWL-840M-L****-BB*		683,00
per meter	4000K	DALI	High	3600lm/26,4W	3,2	LM3LWL-840H-L****-BB*		683,00

Microprismatic | Direct

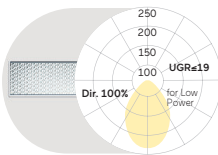

L mm	Colour Temperature	Control	Power	Lumen/Watt	Weight kg	Code	Snow White	CHF
600	4000K	On/Off	Low	820lm/9W	2,1	LM3AWE-840E-L600-B		480,00
600	4000K	On/Off	Medium	1110lm/12W	2,1	LM3AWE-840M-L600-B		480,00
600	4000K	On/Off	High	1570lm/17W	2,1	LM3AWE-840H-L600-B		480,00
890	4000K	On/Off	Low	1230lm/12W	2,7	LM3AWE-840E-L890-B		524,00
890	4000K	On/Off	Medium	1660lm/16W	2,7	LM3AWE-840M-L890-B		524,00
890	4000K	On/Off	High	2350lm/24W	2,7	LM3AWE-840H-L890-B		524,00
1182	4000K	On/Off	Low	1640lm/16W	3,4	LM3AWE-840E-L1182-B		559,00
1182	4000K	On/Off	Medium	2210lm/21W	3,4	LM3AWE-840M-L1182-B		559,00
1182	4000K	On/Off	High	3130lm/31W	3,4	LM3AWE-840H-L1182-B		559,00
1475	4000K	On/Off	Low	2050lm/19W	4,0	LM3AWE-840E-L1475-B		639,00
1475	4000K	On/Off	Medium	2770lm/26W	4,0	LM3AWE-840M-L1475-B		639,00
1475	4000K	On/Off	High	3920lm/37W	4,0	LM3AWE-840H-L1475-B		639,00
1765	4000K	On/Off	Low	2450lm/22W	4,6	LM3AWE-840E-L1765-B		779,00
1765	4000K	On/Off	Medium	3320lm/30W	4,6	LM3AWE-840M-L1765-B		779,00
1765	4000K	On/Off	High	4700lm/44W	4,6	LM3AWE-840H-L1765-B		779,00
2055	4000K	On/Off	Low	2860lm/28W	5,5	LM3AWE-840E-L2055-B		961,00
2055	4000K	On/Off	Medium	3870lm/38W	5,5	LM3AWE-840M-L2055-B		961,00
2055	4000K	On/Off	High	5490lm/54W	5,5	LM3AWE-840H-L2055-B		961,00
per meter	4000K	On/Off	Low	1390lm/12,5W	3,0	LM3AWE-840E-L****-B		464,00
per meter	4000K	On/Off	Medium	1880lm/17,2W	3,0	LM3AWE-840M-L****-B		464,00
per meter	4000K	On/Off	High	2670lm/25,2W	3,0	LM3AWE-840H-L****-B		464,00
per meter	4000K	DALI	Low	1390lm/12,5W	3,0	LM3AWL-840E-L****-B		517,00
per meter	4000K	DALI	Medium	1880lm/17,2W	3,0	LM3AWL-840M-L****-B		517,00
per meter	4000K	DALI	High	2670lm/25,2W	3,0	LM3AWL-840H-L****-B		517,00

Opal Diffuser | Direct

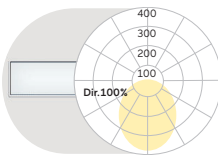

L mm	Colour Temperature	Control	Power	Lumen/Watt	Weight kg	Code	Snow White	CHF
600	4000K	On/Off	Low	900lm/9W	2,1	LM3OWE-840E-L600-B		462,00
600	4000K	On/Off	Medium	1210lm/12W	2,1	LM3OWE-840M-L600-B		462,00
600	4000K	On/Off	High	1720lm/17W	2,1	LM3OWE-840H-L600-B		462,00
890	4000K	On/Off	Low	1350lm/12W	2,7	LM3OWE-840E-L890-B		506,00
890	4000K	On/Off	Medium	1820lm/16W	2,7	LM3OWE-840M-L890-B		506,00
890	4000K	On/Off	High	2580lm/24W	2,7	LM3OWE-840H-L890-B		506,00
1182	4000K	On/Off	Low	1790lm/16W	3,4	LM3OWE-840E-L1182-B		534,00
1182	4000K	On/Off	Medium	2430lm/21W	3,4	LM3OWE-840M-L1182-B		534,00
1182	4000K	On/Off	High	3440lm/31W	3,4	LM3OWE-840H-L1182-B		534,00
1475	4000K	On/Off	Low	2240lm/19W	4,0	LM3OWE-840E-L1475-B		604,00
1475	4000K	On/Off	Medium	3030lm/26W	4,0	LM3OWE-840M-L1475-B		604,00
1475	4000K	On/Off	High	4300lm/37W	4,0	LM3OWE-840H-L1475-B		604,00
1765	4000K	On/Off	Low	2690lm/22W	4,6	LM3OWE-840E-L1765-B		734,00
1765	4000K	On/Off	Medium	3640lm/30W	4,6	LM3OWE-840M-L1765-B		734,00
1765	4000K	On/Off	High	5160lm/44W	4,6	LM3OWE-840H-L1765-B		734,00
2055	4000K	On/Off	Low	3140lm/28W	5,5	LM3OWE-840E-L2055-B		891,00
2055	4000K	On/Off	Medium	4250lm/38W	5,5	LM3OWE-840M-L2055-B		891,00
2055	4000K	On/Off	High	6020lm/54W	5,5	LM3OWE-840H-L2055-B		891,00
per meter	4000K	On/Off	Low	1530lm/12,5W	3,0	LM3OWE-840E-L****-B		438,00
per meter	4000K	On/Off	Medium	2060lm/17,2W	3,0	LM3OWE-840M-L****-B		438,00
per meter	4000K	On/Off	High	2930lm/25,2W	3,0	LM3OWE-840H-L****-B		438,00
per meter	4000K	DALI	Low	1530lm/12,5W	3,0	LM3OWL-840E-L****-B		490,00
per meter	4000K	DALI	Medium	2060lm/17,2W	3,0	LM3OWL-840M-L****-B		490,00
per meter	4000K	DALI	High	2930lm/25,2W	3,0	LM3OWL-840H-L****-B		490,00

**** Your length in mm

Meterpreise für Lichtsysteme nach Maß ab Mindestlänge 2200mm | Prices per meter for customised lighting systems with a minimum length of 2200mm | Prix au mètre pour systèmes d'éclairage sur mesure à partir d'une longueur minimale de 2200mm

Wallwasher | Direct

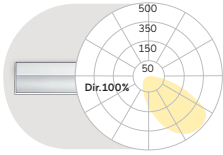

L mm	Colour Temperature	Control	Power	Lumen/Watt	Weight kg	Code Snow White	CHF
600	4000K	On/Off	Medium	750lm/11W	2,2	LM3GWE-840M-L600-B	515,00
600	4000K	On/Off	High	1030lm/15W	2,2	LM3GWE-840H-L600-B	515,00
890	4000K	On/Off	Medium	1130lm/15W	2,8	LM3GWE-840M-L890-B	550,00
890	4000K	On/Off	High	1540lm/21W	2,8	LM3GWE-840H-L890-B	550,00
1182	4000K	On/Off	Medium	1500lm/19W	3,5	LM3GWE-840M-L1182-B	602,00
1182	4000K	On/Off	High	2060lm/27W	3,5	LM3GWE-840H-L1182-B	602,00
1475	4000K	On/Off	Medium	1880lm/23W	4,2	LM3GWE-840M-L1475-B	683,00
1475	4000K	On/Off	High	2570lm/33W	4,2	LM3GWE-840H-L1475-B	683,00
1765	4000K	On/Off	Medium	2250lm/28W	4,8	LM3GWE-840M-L1765-B	832,00
1765	4000K	On/Off	High	3090lm/39W	4,8	LM3GWE-840H-L1765-B	832,00
2055	4000K	On/Off	Medium	2630lm/34W	5,7	LM3GWE-840M-L2055-B	1014,00
2055	4000K	On/Off	High	3600lm/47W	5,7	LM3GWE-840H-L2055-B	1014,00
per meter	4000K	On/Off	Medium	1280lm/15,6W	3,1	LM3GWE-840M-L****-B	490,00
per meter	4000K	On/Off	High	1750lm/21,9W	3,1	LM3GWE-840H-L****-B	490,00
per meter	4000K	DALI	Medium	1280lm/15,6W	3,1	LM3GWL-840M-L****-B	543,00
per meter	4000K	DALI	High	1750lm/21,9W	3,1	LM3GWL-840H-L****-B	543,00

**** Your length in mm

Meterpreise für Lichtsysteme nach Maß ab Mindestlänge 2200mm | Prices per meter for customised lighting systems with a minimum length of 2200mm | Prix au mètre pour systèmes d'éclairage sur mesure à partir d'une longueur minimale de 2200mm



90° Corner
Opal/Microprismatic

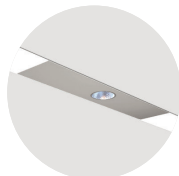

Midpin-Downlight XD
770lm/10W/Ø40mm

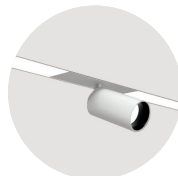

Midpin Spotlight XM
770lm/10W/Ø40mm

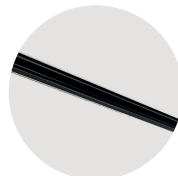

3-Phase Track

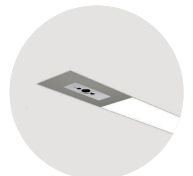

Multisensor

Surcharges

Optical System	CHF	Control Gear	CHF L600-L1765	CHF L2055	Colour Temperature	CHF	Lens Louvre*	CHF	Installation	CHF
O: Opal Diffuser (PMMA)	✓	E: On/Off	✓	✓	22: 2200K	+5%	W: Snow White	✓	B: Installation Brackets	✓
D: Opal Diffuser Polycarbonate*	+5%	L: DALI	+86,00	+172,00	27: 2700K	+5%	A: Satin Silver	✓	F: Installation Housing	+20%
		H: Touch-Dim	+86,00	+172,00	30: 3000K	✓	B: Jet Black	✓	Additional Options	CHF
		C: Casambi	+261,00	+261,00	35: 3500K	+5%	H: Anodic Champagne	✓	90° Corner	ⓘ
		6: DALI DT6 for TW	+172,00	+343,00	40: 4000K	✓	K: Satin Copper	✓	Midpin Downlight XD	+363,00
		8: DALI DT8 for TW	+172,00	+343,00	65: 6500K	+5%	G: Satin Gold	✓	Midpin Spotlight XM	+363,00
					TW: Tunable White 2700-6500K** [L1182-L2055]	+30%			Multisensor [L1182-L2055]	+261,00
									Emergency Module [DALI, Autotest, incl. 3H Battery] [L1182-L2055]	+366,00
		Colour Rendering	CHF							
		8: CRI>80	✓							
		9: CRI>90	+5%							
		F: Full Spectrum	+15%							

*Opal Diffuser made of sustainable Trucircle Polycarbonate / Fire Rated - Glow wire flammability Index 950°C EN60695-2-12 / Tp(a). Luminous flux reduction of 10%.

**Only in combination with DALI. Please add to dimming price.

*Only in combination with DT6, DT8 or Casambi control. Please add additional control price.

✓ standard / no extra charge ⓘ on request ✗ not available

Matric F3 | System 55mm Recessed Frame

catalogue page 504

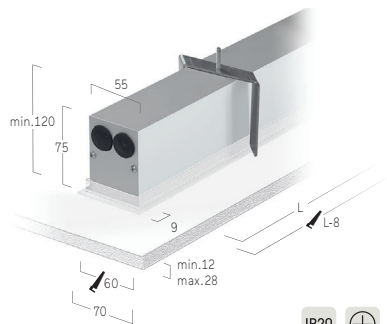

... Matric F3 | System 55mm Recessed Frameless

Lens Louvre | Direct

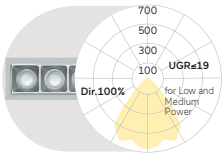

L mm	Colour Temperature	Control	Power	Lumen/Watt	Weight kg	Code Snow White/Jet Black	Code Silver Anodised/Jet Black	CHF
768	4000K	On/Off	Low	1370lm/11W	2,2	LF3LWE-840E-L768-B*	LF3LEE-840E-L768-B*	657,00
768	4000K	On/Off	Medium	1870lm/15W	2,2	LF3LWE-840M-L768-B*	LF3LEE-840M-L768-B*	657,00
768	4000K	On/Off	High	2690lm/22W	2,2	LF3LWE-840H-L768-B*	LF3LEE-840H-L768-B*	657,00
1018	4000K	On/Off	Low	1830lm/14W	2,9	LF3LWE-840E-L1018-B*	LF3LEE-840E-L1018-B*	672,00
1018	4000K	On/Off	Medium	2500lm/19W	2,9	LF3LWE-840M-L1018-B*	LF3LEE-840M-L1018-B*	672,00
1018	4000K	On/Off	High	3590lm/28W	2,9	LF3LWE-840H-L1018-B*	LF3LEE-840H-L1018-B*	672,00
1268	4000K	On/Off	Low	2290lm/16W	3,5	LF3LWE-840E-L1268-B*	LF3LEE-840E-L1268-B*	760,00
1268	4000K	On/Off	Medium	3120lm/23W	3,5	LF3LWE-840M-L1268-B*	LF3LEE-840M-L1268-B*	760,00
1268	4000K	On/Off	High	4500lm/34W	3,5	LF3LWE-840H-L1268-B*	LF3LEE-840H-L1268-B*	760,00
1518	4000K	On/Off	Low	2750lm/19W	4,1	LF3LWE-840E-L1518-B*	LF3LEE-840E-L1518-B*	893,00
1518	4000K	On/Off	Medium	3750lm/27W	4,1	LF3LWE-840M-L1518-B*	LF3LEE-840M-L1518-B*	893,00
1518	4000K	On/Off	High	5380lm/40W	4,1	LF3LWE-840H-L1518-B*	LF3LEE-840H-L1518-B*	893,00
1768	4000K	On/Off	Low	3200lm/22W	4,7	LF3LWE-840E-L1768-B*	LF3LEE-840E-L1768-B*	1068,00
1768	4000K	On/Off	Medium	4370lm/31W	4,7	LF3LWE-840M-L1768-B*	LF3LEE-840M-L1768-B*	1068,00
1768	4000K	On/Off	High	6280lm/46W	4,7	LF3LWE-840H-L1768-B*	LF3LEE-840H-L1768-B*	1068,00
2018	4000K	On/Off	Low	3660lm/25W	5,6	LF3LWE-840E-L2018-B*	LF3LEE-840E-L2018-B*	1287,00
2018	4000K	On/Off	Medium	5000lm/35W	5,6	LF3LWE-840M-L2018-B*	LF3LEE-840M-L2018-B*	1287,00
2018	4000K	On/Off	High	7180lm/53W	5,6	LF3LWE-840H-L2018-B*	LF3LEE-840H-L2018-B*	1287,00
per meter	4000K	On/Off	Low	1830lm/12,3W	2,9	LF3LWE-840E-L****-B*	LF3LEE-840E-L****-B*	639,00
per meter	4000K	On/Off	Medium	2500lm/17,3W	2,9	LF3LWE-840M-L****-B*	LF3LEE-840M-L****-B*	639,00
per meter	4000K	On/Off	High	3600lm/26,4W	2,9	LF3LWE-840H-L****-B*	LF3LEE-840H-L****-B*	639,00
per meter	4000K	DALI	Low	1830lm/12,3W	2,9	LF3LWL-840E-L****-B*	LF3LEEL-840E-L****-B*	692,00
per meter	4000K	DALI	Medium	2500lm/17,3W	2,9	LF3LWL-840M-L****-B*	LF3LEEL-840M-L****-B*	692,00
per meter	4000K	DALI	High	3600lm/26,4W	2,9	LF3LWL-840H-L****-B*	LF3LEEL-840H-L****-B*	692,00

Microprismatic | Direct

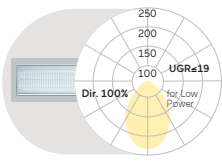

L mm	Colour Temperature	Control	Power	Lumen/Watt	Weight kg	Code Snow White	Code Silver Anodised	CHF
615	4000K	On/Off	Low	820lm/9W	1,7	LF3AWE-840E-L615	LF3AEE-840E-L615	489,00
615	4000K	On/Off	Medium	1110lm/12W	1,7	LF3AWE-840M-L615	LF3AEE-840M-L615	489,00
615	4000K	On/Off	High	1570lm/17W	1,7	LF3AWE-840H-L615	LF3AEE-840H-L615	489,00
905	4000K	On/Off	Low	1230lm/12W	2,4	LF3AWE-840E-L905	LF3AEE-840E-L905	532,00
905	4000K	On/Off	Medium	1660lm/16W	2,4	LF3AWE-840M-L905	LF3AEE-840M-L905	532,00
905	4000K	On/Off	High	2350lm/24W	2,4	LF3AWE-840H-L905	LF3AEE-840H-L905	532,00
1198	4000K	On/Off	Low	1640lm/16W	3,0	LF3AWE-840E-L1198	LF3AEE-840E-L1198	567,00
1198	4000K	On/Off	Medium	2210lm/21W	3,0	LF3AWE-840M-L1198	LF3AEE-840M-L1198	567,00
1198	4000K	On/Off	High	3130lm/31W	3,0	LF3AWE-840H-L1198	LF3AEE-840H-L1198	567,00
1490	4000K	On/Off	Low	2050lm/19W	3,7	LF3AWE-840E-L1490	LF3AEE-840E-L1490	648,00
1490	4000K	On/Off	Medium	2770lm/26W	3,7	LF3AWE-840M-L1490	LF3AEE-840M-L1490	648,00
1490	4000K	On/Off	High	3920lm/37W	3,7	LF3AWE-840H-L1490	LF3AEE-840H-L1490	648,00
1780	4000K	On/Off	Low	2450lm/22W	4,3	LF3AWE-840E-L1780	LF3AEE-840E-L1780	788,00
1780	4000K	On/Off	Medium	3320lm/30W	4,3	LF3AWE-840M-L1780	LF3AEE-840M-L1780	788,00
1780	4000K	On/Off	High	4700lm/44W	4,3	LF3AWE-840H-L1780	LF3AEE-840H-L1780	788,00
2075	4000K	On/Off	Low	2860lm/28W	5,2	LF3AWE-840E-L2075	LF3AEE-840E-L2075	970,00
2075	4000K	On/Off	Medium	3870lm/38W	5,2	LF3AWE-840M-L2075	LF3AEE-840M-L2075	970,00
2075	4000K	On/Off	High	5490lm/54W	5,2	LF3AWE-840H-L2075	LF3AEE-840H-L2075	970,00
per meter	4000K	On/Off	Low	1390lm/12,5W	2,5	LF3AWE-840E-L****	LF3AEE-840E-L****	473,00
per meter	4000K	On/Off	Medium	1880lm/17,2W	2,5	LF3AWE-840M-L****	LF3AEE-840M-L****	473,00
per meter	4000K	On/Off	High	2670lm/25,2W	2,5	LF3AWE-840H-L****	LF3AEE-840H-L****	473,00
per meter	4000K	DALI	Low	1390lm/12,5W	2,5	LF3AWL-840E-L****	LF3AEEL-840E-L****	525,00
per meter	4000K	DALI	Medium	1880lm/17,2W	2,5	LF3AWL-840M-L****	LF3AEEL-840M-L****	525,00
per meter	4000K	DALI	High	2670lm/25,2W	2,5	LF3AWL-840H-L****	LF3AEEL-840H-L****	525,00

Opal Diffuser | Direct

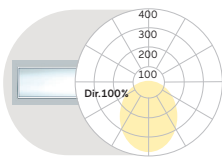

L mm	Colour Temperature	Control	Power	Lumen/Watt	Weight kg	Code Snow White	Code Silver Anodised	CHF
615	4000K	On/Off	Low	900lm/9W	1,7	LF3OWE-840E-L615	LF3OEE-840E-L615	471,00
615	4000K	On/Off	Medium	1210lm/12W	1,7	LF3OWE-840M-L615	LF3OEE-840M-L615	471,00
615	4000K	On/Off	High	1720lm/17W	1,7	LF3OWE-840H-L615	LF3OEE-840H-L615	471,00
905	4000K	On/Off	Low	1350lm/12W	2,4	LF3OWE-840E-L905	LF3OEE-840E-L905	515,00
905	4000K	On/Off	Medium	1820lm/16W	2,4	LF3OWE-840M-L905	LF3OEE-840M-L905	515,00
905	4000K	On/Off	High	2580lm/24W	2,4	LF3OWE-840H-L905	LF3OEE-840H-L905	515,00
1198	4000K	On/Off	Low	1790lm/16W	3,0	LF3OWE-840E-L1198	LF3OEE-840E-L1198	543,00
1198	4000K	On/Off	Medium	2430lm/21W	3,0	LF3OWE-840M-L1198	LF3OEE-840M-L1198	543,00
1198	4000K	On/Off	High	3440lm/31W	3,0	LF3OWE-840H-L1198	LF3OEE-840H-L1198	543,00
1490	4000K	On/Off	Low	2240lm/19W	3,7	LF3OWE-840E-L1490	LF3OEE-840E-L1490	613,00
1490	4000K	On/Off	Medium	3030lm/26W	3,7	LF3OWE-840M-L1490	LF3OEE-840M-L1490	613,00
1490	4000K	On/Off	High	4300lm/37W	3,7	LF3OWE-840H-L1490	LF3OEE-840H-L1490	613,00
1780	4000K	On/Off	Low	2690lm/22W	4,3	LF3OWE-840E-L1780	LF3OEE-840E-L1780	742,00
1780	4000K	On/Off	Medium	3640lm/30W	4,3	LF3OWE-840M-L1780	LF3OEE-840M-L1780	742,00
1780	4000K	On/Off	High	5160lm/44W	4,3	LF3OWE-840H-L1780	LF3OEE-840H-L1780	742,00
2075	4000K	On/Off	Low	3140lm/28W	5,2	LF3OWE-840E-L2075	LF3OEE-840E-L2075	900,00
2075	4000K	On/Off	Medium	4250lm/38W	5,2	LF3OWE-840M-L2075	LF3OEE-840M-L2075	900,00
2075	4000K	On/Off	High	6020lm/54W	5,2	LF3OWE-840H-L2075	LF3OEE-840H-L2075	900,00
per meter	4000K	On/Off	Low	1530lm/12,5W	2,5	LF3OWE-840E-L****	LF3OEE-840E-L****	447,00
per meter	4000K	On/Off	Medium	2060lm/17,2W	2,5	LF3OWE-840M-L****	LF3OEE-840M-L****	447,00
per meter	4000K	On/Off	High	2930lm/25,2W	2,5	LF3OWE-840H-L****	LF3OEE-840H-L****	447,00
per meter	4000K	DALI	Low	1530lm/12,5W	2,5	LF3OWL-840E-L****	LF3OEL-840E-L****	499,00
per meter	4000K	DALI	Medium	2060lm/17,2W	2,5	LF3OWL-840M-L****	LF3OEL-840M-L****	499,00
per meter	4000K	DALI	High	2930lm/25,2W	2,5	LF3OWL-840H-L****	LF3OEL-840H-L****	499,00

**** Your length in mm

Meterpreise für Lichtsysteme nach Maß ab Mindestlänge 2200mm | Prices per metre for customised lighting systems with a minimum length of 2200mm
 Prix au mètre pour systèmes d'éclairage sur mesure à partir d'une longueur minimale de 2200mm

Wallwasher | Direct

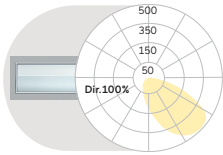

L mm	Colour Temperature	Control	Power	Lumen/Watt	Weight kg	Code Snow White	Code Silver Anodised	CHF
615	4000K	On/Off	Medium	750lm/11W	1,8	LF3GWE-840M-L615	LF3GEE-840M-L615	524,00
615	4000K	On/Off	High	1030lm/15W	1,8	LF3GWE-840H-L615	LF3GEE-840H-L615	524,00
905	4000K	On/Off	Medium	1130lm/15W	2,5	LF3GWE-840M-L905	LF3GEE-840M-L905	559,00
905	4000K	On/Off	High	1540lm/21W	2,5	LF3GWE-840H-L905	LF3GEE-840H-L905	559,00
1198	4000K	On/Off	Medium	1500lm/19W	3,2	LF3GWE-840M-L1198	LF3GEE-840M-L1198	611,00
1198	4000K	On/Off	High	2060lm/27W	3,2	LF3GWE-840H-L1198	LF3GEE-840H-L1198	611,00
1490	4000K	On/Off	Medium	1880lm/23W	3,9	LF3GWE-840M-L1490	LF3GEE-840M-L1490	692,00
1490	4000K	On/Off	High	2570lm/33W	3,9	LF3GWE-840H-L1490	LF3GEE-840H-L1490	692,00
1780	4000K	On/Off	Medium	2250lm/28W	4,5	LF3GWE-840M-L1780	LF3GEE-840M-L1780	840,00
1780	4000K	On/Off	High	3090lm/39W	4,5	LF3GWE-840H-L1780	LF3GEE-840H-L1780	840,00
2075	4000K	On/Off	Medium	2630lm/34W	5,5	LF3GWE-840M-L2075	LF3GEE-840M-L2075	1022,00
2075	4000K	On/Off	High	3600lm/47W	5,5	LF3GWE-840H-L2075	LF3GEE-840H-L2075	1022,00
per meter	4000K	On/Off	Medium	1280lm/15,6W	2,7	LF3GWE-840M-L****	LF3GEE-840M-L****	499,00
per meter	4000K	On/Off	High	1750lm/21,9W	2,7	LF3GWE-840H-L****	LF3GEE-840H-L****	499,00
per meter	4000K	DALI	Medium	1280lm/15,6W	2,7	LF3GWL-840M-L****	LF3GEL-840M-L****	552,00
per meter	4000K	DALI	High	1750lm/21,9W	2,7	LF3GWL-840H-L****	LF3GEL-840H-L****	552,00

**** Your length in mm

Meterpreise für Lichtsysteme nach Maß ab Mindestlänge 2200mm | Prices per metre for customised lighting systems with a minimum length of 2200mm
 Prix au mètre pour systèmes d'éclairage sur mesure à partir d'une longueur minimale de 2200mm



90° Corner
Opal/Microprismatic

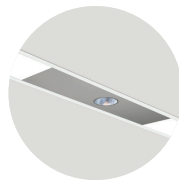

Midpin-Downlight XD
770lm/10W/Ø40mm

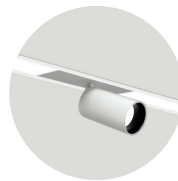

Midpin Spotlight XM
770lm/10W/Ø40mm

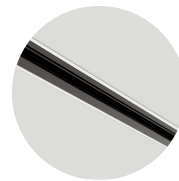

3-Phase Track



Multisensor

Surcharges

Surface Finish

W: Snow White	✓	CHF
E: Silver Anodised	✓	CHF
U: Urban Graphite	✓	CHF
B: Jet Black	✓	CHF
H: Anodic Champagne	+10%	CHF
K: Satin Copper	+15%	CHF
R: Special RAL/NCS Colours	🔴	CHF

Control Gear

E: On/Off	✓	CHF
L: DALI	+86,00	CHF
H: Touch-Dim	+86,00	CHF
C: Casambi*	+261,00	CHF
6: DALI DT6 for TW [L1198-L2075]	+172,00	CHF
8: DALI DT8 for TW [L905-L2075]	+172,00	CHF

*Only in combination with DALI. Please add to dimming price.

Colour Rendering

8: CRI>80	✓	CHF
9: CRI>90	+5%	CHF
F: Full Spectrum	+15%	CHF

Lens Louvre*

W: Snow White	✓	CHF
S: Radiant Silver	✓	CHF
U: Urban Graphite	✓	CHF
B: Jet Black	✓	CHF
H: Anodic Champagne	✓	CHF
K: Satin Copper	✓	CHF
G: Satin Gold	✓	CHF

Colour Temperature

22: 2200K	+5%	CHF
27: 2700K	+5%	CHF
30: 3000K	✓	CHF
35: 3500K	+5%	CHF
40: 4000K	✓	CHF
65: 6500K	+5%	CHF
TW: Tunable White 2700-6500K*	+30%	CHF

*Only in combination with DT6, DT8 or Casambi control. Please add additional control price.

Additional Options

90° Corner	🔴	CHF
Midpin Downlight XD	+363,00	CHF
Midpin Spotlight XM	+363,00	CHF
Multisensor [L1198-L2075]	+261,00	CHF
Emergency Module [DALI, Autotest, incl. 3H Battery] [L1198-L2075]	+366,00	CHF

✓ standard / no extra charge 🔴 on request 🚫 not available

Matric M5 | System 81mm Recessed Frameless

catalogue page 506

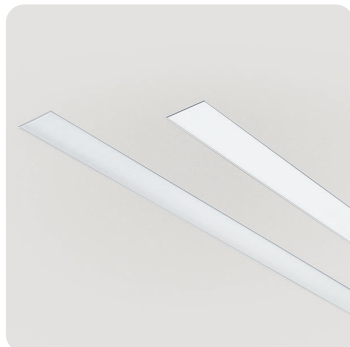

B: Installation Bracket without Shadow Gap

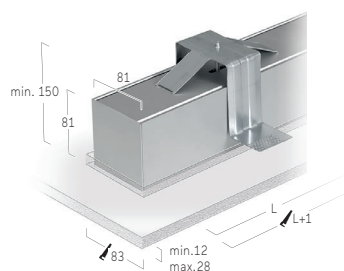

F: Installation Housing with Shadow Gap

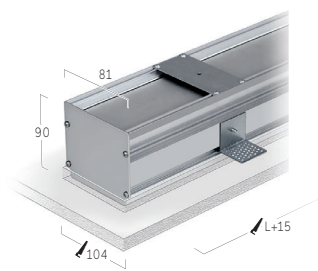

... Matric M5 | System 81mm Recessed Frameless

Microprismatic | Direct

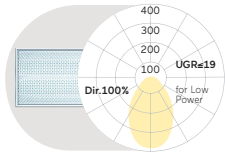

L mm	Colour Temperature	Control	Power	Lumen/Watt	Weight kg	Code Snow White	CHF
600	4000K	On/Off	Low	1000lm/11W	2,7	LM5AWE-840E-L600-B	490,00
600	4000K	On/Off	Medium	1380lm/15W	2,7	LM5AWE-840M-L600-B	490,00
600	4000K	On/Off	High	2010lm/21W	2,7	LM5AWE-840H-L600-B	490,00
890	4000K	On/Off	Low	1510lm/15W	3,5	LM5AWE-840E-L890-B	541,00
890	4000K	On/Off	Medium	2070lm/21W	3,5	LM5AWE-840M-L890-B	541,00
890	4000K	On/Off	High	3020lm/31W	3,5	LM5AWE-840H-L890-B	541,00
1182	4000K	On/Off	Low	2010lm/19W	4,3	LM5AWE-840E-L1182-B	588,00
1182	4000K	On/Off	Medium	2760lm/26W	4,3	LM5AWE-840M-L1182-B	588,00
1182	4000K	On/Off	High	4020lm/40W	4,3	LM5AWE-840H-L1182-B	588,00
1475	4000K	On/Off	Low	2510lm/23W	5,2	LM5AWE-840E-L1475-B	674,00
1475	4000K	On/Off	Medium	3450lm/32W	5,2	LM5AWE-840M-L1475-B	674,00
1475	4000K	On/Off	High	5030lm/49W	5,2	LM5AWE-840H-L1475-B	674,00
1765	4000K	On/Off	Low	3010lm/27W	6,0	LM5AWE-840E-L1765-B	832,00
1765	4000K	On/Off	Medium	4140lm/38W	6,0	LM5AWE-840M-L1765-B	832,00
1765	4000K	On/Off	High	6030lm/59W	6,0	LM5AWE-840H-L1765-B	832,00
2055	4000K	On/Off	Low	3510lm/34W	7,0	LM5AWE-840E-L2055-B	1024,00
2055	4000K	On/Off	Medium	4830lm/47W	7,0	LM5AWE-840M-L2055-B	1024,00
2055	4000K	On/Off	High	7040lm/71W	7,0	LM5AWE-840H-L2055-B	1024,00
per meter	4000K	On/Off	Low	1710lm/15,5W	3,8	LM5AWE-840E-L****-B	508,00
per meter	4000K	On/Off	Medium	2350lm/21,7W	3,8	LM5AWE-840M-L****-B	508,00
per meter	4000K	On/Off	High	3420lm/33,3W	3,8	LM5AWE-840H-L****-B	508,00
per meter	4000K	DALI	Low	1710lm/15,5W	3,8	LM5AWL-840E-L****-B	560,00
per meter	4000K	DALI	Medium	2350lm/21,7W	3,8	LM5AWL-840M-L****-B	560,00
per meter	4000K	DALI	High	3420lm/33,3W	3,8	LM5AWL-840H-L****-B	560,00

Opal Diffuser | Direct

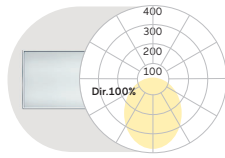

L mm	Colour Temperature	Control	Power	Lumen/Watt	Weight kg	Code Snow White	CHF
600	4000K	On/Off	Low	1180lm/11W	2,8	LM5OWE-840E-L600-B	473,00
600	4000K	On/Off	Medium	1620lm/15W	2,8	LM5OWE-840M-L600-B	473,00
600	4000K	On/Off	High	2360lm/21W	2,8	LM5OWE-840H-L600-B	473,00
890	4000K	On/Off	Low	1760lm/15W	3,6	LM5OWE-840E-L890-B	524,00
890	4000K	On/Off	Medium	2430lm/21W	3,6	LM5OWE-840M-L890-B	524,00
890	4000K	On/Off	High	3530lm/31W	3,6	LM5OWE-840H-L890-B	524,00
1182	4000K	On/Off	Low	2350lm/19W	4,4	LM5OWE-840E-L1182-B	560,00
1182	4000K	On/Off	Medium	3230lm/26W	4,4	LM5OWE-840M-L1182-B	560,00
1182	4000K	On/Off	High	4710lm/40W	4,4	LM5OWE-840H-L1182-B	560,00
1475	4000K	On/Off	Low	2940lm/23W	5,3	LM5OWE-840E-L1475-B	639,00
1475	4000K	On/Off	Medium	4040lm/32W	5,3	LM5OWE-840M-L1475-B	639,00
1475	4000K	On/Off	High	5890lm/49W	5,3	LM5OWE-840H-L1475-B	639,00
1765	4000K	On/Off	Low	3530lm/27W	6,1	LM5OWE-840E-L1765-B	786,00
1765	4000K	On/Off	Medium	4850lm/38W	6,1	LM5OWE-840M-L1765-B	786,00
1765	4000K	On/Off	High	7070lm/59W	6,1	LM5OWE-840H-L1765-B	786,00
2055	4000K	On/Off	Low	4120lm/34W	7,2	LM5OWE-840E-L2055-B	961,00
2055	4000K	On/Off	Medium	5660lm/47W	7,2	LM5OWE-840M-L2055-B	961,00
2055	4000K	On/Off	High	8240lm/71W	7,2	LM5OWE-840H-L2055-B	961,00
per meter	4000K	On/Off	Low	2000lm/15,5W	3,9	LM5OWE-840E-L****-B	473,00
per meter	4000K	On/Off	Medium	2750lm/21,7W	3,9	LM5OWE-840M-L****-B	473,00
per meter	4000K	On/Off	High	4010lm/33,3W	3,9	LM5OWE-840H-L****-B	473,00
per meter	4000K	DALI	Low	2000lm/15,5W	3,9	LM5OWL-840E-L****-B	525,00
per meter	4000K	DALI	Medium	2750lm/21,7W	3,9	LM5OWL-840M-L****-B	525,00
per meter	4000K	DALI	High	4010lm/33,3W	3,9	LM5OWL-840H-L****-B	525,00

Satin Louvre | Direct

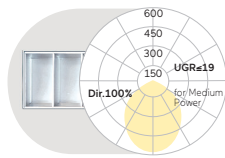

L mm	Colour Temperature	Control	Power	Lumen/Watt	Weight kg	Code Snow White	CHF
600	4000K	On/Off	Medium	1270lm/15W	2,8	LM5MWE-840M-L600-B	497,00
600	4000K	On/Off	High	1840lm/21W	2,8	LM5MWE-840H-L600-B	497,00
890	4000K	On/Off	Medium	1900lm/21W	3,6	LM5MWE-840M-L890-B	567,00
890	4000K	On/Off	High	2770lm/31W	3,6	LM5MWE-840H-L890-B	567,00
1182	4000K	On/Off	Medium	2530lm/26W	4,4	LM5MWE-840M-L1182-B	615,00
1182	4000K	On/Off	High	3690lm/40W	4,4	LM5MWE-840H-L1182-B	615,00
1475	4000K	On/Off	Medium	3170lm/32W	5,3	LM5MWE-840M-L1475-B	676,00
1475	4000K	On/Off	High	4610lm/49W	5,3	LM5MWE-840H-L1475-B	676,00
1765	4000K	On/Off	Medium	3800lm/38W	6,1	LM5MWE-840M-L1765-B	770,00
1765	4000K	On/Off	High	5530lm/59W	6,1	LM5MWE-840H-L1765-B	770,00
2055	4000K	On/Off	Medium	4430lm/47W	7,2	LM5MWE-840M-L2055-B	965,00
2055	4000K	On/Off	High	6450lm/71W	7,2	LM5MWE-840H-L2055-B	965,00

Wallwasher | Direct

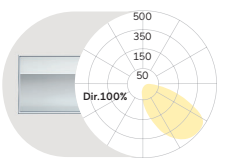

L mm	Colour Temperature	Control	Power	Lumen/Watt	Weight kg	Code Snow White	CHF
600	4000K	On/Off	High	1180lm/15W	2,8	LM5GWE-840H-L600-B	550,00
890	4000K	On/Off	High	1770lm/21W	3,6	LM5GWE-840H-L890-B	567,00
1182	4000K	On/Off	High	2360lm/27W	4,4	LM5GWE-840H-L1182-B	615,00
1475	4000K	On/Off	High	2950lm/33W	5,3	LM5GWE-840H-L1475-B	676,00
1765	4000K	On/Off	High	3540lm/39W	6,1	LM5GWE-840H-L1765-B	840,00
2055	4000K	On/Off	High	4130lm/47W	7,2	LM5GWE-840H-L2055-B	1050,00
per meter	4000K	On/Off	High	2010lm/21,9W	3,9	LM5GWE-840H-L****-B	499,00
per meter	4000K	DALI	High	2010lm/21,9W	3,9	LM5GWL-840H-L****-B	552,00

**** Your length in mm

Meterpreise für Lichtsysteme nach Maß ab Mindestlänge 2200mm | Prices per meter for customised lighting systems with a minimum length of 2200mm | Prix au mètre pour systèmes d'éclairage sur mesure à partir d'une longueur minimale de 2200mm



90° Corner
Opal/Microprismatic

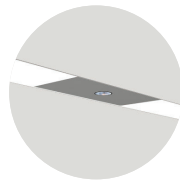

Midpin-Downlight XD
770lm/10W/Ø40mm

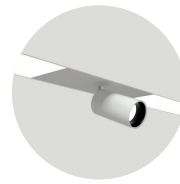

Midpin Spotlight XM
770lm/10W/Ø40mm



Midpoint Spotlight XM
1000lm/19W-3000lm/31W
Ø90mm

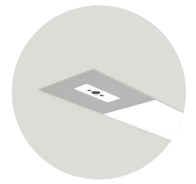

Multisensor

Surcharges

Control Gear	CHF	CHF	Colour Rendering	CHF	Colour Temperature	CHF	Installation	CHF
	L600-L1765	L2055	8: CRI>80	✓	22: 2200K	+5%	B: Installation Brackets	✓
E: On/Off	✓	✓	9: CRI>90	+5%	27: 2700K	+5%	F: Installation Housing	+20%
L: DALI	+86,00	+172,00	F: Full Spectrum	+15%	30: 3000K	✓		
H: Touch-Dim	+86,00	+172,00			35: 3500K	+5%	Additional Options	CHF
C: Casambi*	+261,00	+261,00			40: 4000K	✓	90° Corner	ⓘ
6: DALI DT6 for TW	+172,00	+343,00			65: 6500K	+5%	Midpin Downlight XD	+363,00
8: DALI DT8 for TW	+172,00	+343,00			TW: Tunable White 2700-6500K* [L890-L2055]	+30%	Midpin Spotlight XM	+363,00
							Midpoint Spotlight XM	+368,00
							Multisensor [L1182-L2055]	+261,00
							Emergency Module [DALI, Autotest, incl. 3H Battery] [L1182-L2055]	+366,00

*Only in combination with DALI. Please add to dimming price.

*Only in combination with DT6, DT8 or Casambi control. Please add additional control price.

✓ standard / no extra charge ⓘ on request ✗ not available

Matric F5 | System 81 mm Recessed Frame

catalogue page 508

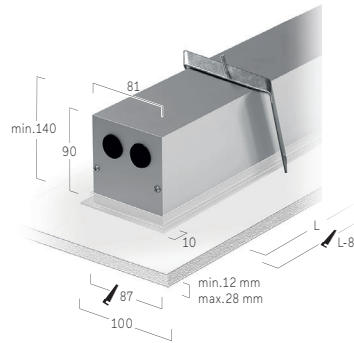
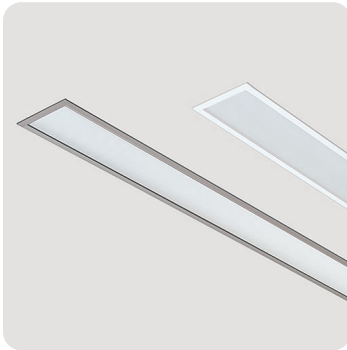

Microprismatic | Direct

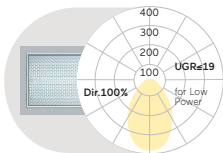

L mm	Colour Temperature	Control	Power	Lumen/Watt	Weight kg	Code Snow White	Code Silver Anodised	CHF
615	4000K	On/Off	Low	1000lm/11W	2,3	LF5AWE-840E-L615	LF5AEE-840E-L615	499,00
615	4000K	On/Off	Medium	1380lm/15W	2,3	LF5AWE-840M-L615	LF5AEE-840M-L615	499,00
615	4000K	On/Off	High	2010lm/21W	2,3	LF5AWE-840H-L615	LF5AEE-840H-L615	499,00
905	4000K	On/Off	Low	1510lm/15W	3,2	LF5AWE-840E-L905	LF5AEE-840E-L905	550,00
905	4000K	On/Off	Medium	2070lm/21W	3,2	LF5AWE-840M-L905	LF5AEE-840M-L905	550,00
905	4000K	On/Off	High	3020lm/31W	3,2	LF5AWE-840H-L905	LF5AEE-840H-L905	550,00
1198	4000K	On/Off	Low	2010lm/19W	4,0	LF5AWE-840E-L1198	LF5AEE-840E-L1198	597,00
1198	4000K	On/Off	Medium	2760lm/26W	4,0	LF5AWE-840M-L1198	LF5AEE-840M-L1198	597,00
1198	4000K	On/Off	High	4020lm/40W	4,0	LF5AWE-840H-L1198	LF5AEE-840H-L1198	597,00
1490	4000K	On/Off	Low	2510lm/23W	4,9	LF5AWE-840E-L1490	LF5AEE-840E-L1490	683,00
1490	4000K	On/Off	Medium	3450lm/32W	4,9	LF5AWE-840M-L1490	LF5AEE-840M-L1490	683,00
1490	4000K	On/Off	High	5030lm/49W	4,9	LF5AWE-840H-L1490	LF5AEE-840H-L1490	683,00
1780	4000K	On/Off	Low	3010lm/27W	5,7	LF5AWE-840E-L1780	LF5AEE-840E-L1780	840,00
1780	4000K	On/Off	Medium	4140lm/38W	5,7	LF5AWE-840M-L1780	LF5AEE-840M-L1780	840,00
1780	4000K	On/Off	High	6030lm/59W	5,7	LF5AWE-840H-L1780	LF5AEE-840H-L1780	840,00
2075	4000K	On/Off	Low	3510lm/34W	6,9	LF5AWE-840E-L2075	LF5AEE-840E-L2075	1033,00
2075	4000K	On/Off	Medium	4830lm/47W	6,9	LF5AWE-840M-L2075	LF5AEE-840M-L2075	1033,00
2075	4000K	On/Off	High	7040lm/71W	6,9	LF5AWE-840H-L2075	LF5AEE-840H-L2075	1033,00
per meter	4000K	On/Off	Low	1710lm/15,5W	3,4	LF5AWE-840E-L****	LF5AEE-840E-L****	517,00
per meter	4000K	On/Off	Medium	2350lm/21,7W	3,4	LF5AWE-840M-L****	LF5AEE-840M-L****	517,00
per meter	4000K	On/Off	High	3420lm/33,3W	3,4	LF5AWE-840H-L****	LF5AEE-840H-L****	517,00
per meter	4000K	DALI	Low	1710lm/15,5W	3,4	LF5AWL-840E-L****	LF5AEL-840E-L****	569,00
per meter	4000K	DALI	Medium	2350lm/21,7W	3,4	LF5AWL-840M-L****	LF5AEL-840M-L****	569,00
per meter	4000K	DALI	High	3420lm/33,3W	3,4	LF5AWL-840H-L****	LF5AEL-840H-L****	569,00

**** Your length in mm

Meterpreise für Lichtsysteme nach Maß ab Mindestlänge 2200mm | Prices per metre for customised lighting systems with a minimum length of 2200mm
Prix au mètre pour systèmes d'éclairage sur mesure à partir d'une longueur minimale de 2200mm

... Matric F5 | System 81mm Recessed Frameless

Opal Diffuser | Direct

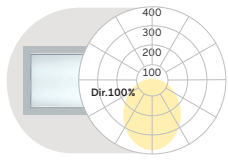

L mm	Colour Temperature	Control	Power	Lumen/Watt	Weight kg	Code Snow White	Code Silver Anodised	CHF
615	4000K	On/Off	Low	1180lm/11W	2,3	LF5OWE-840E-L615	LF5OEE-840E-L615	482,00
615	4000K	On/Off	Medium	1620lm/15W	2,3	LF5OWE-840M-L615	LF5OEE-840M-L615	482,00
615	4000K	On/Off	High	2360lm/21W	2,3	LF5OWE-840H-L615	LF5OEE-840H-L615	482,00
905	4000K	On/Off	Low	1760lm/15W	3,2	LF5OWE-840E-L905	LF5OEE-840E-L905	532,00
905	4000K	On/Off	Medium	2430lm/21W	3,2	LF5OWE-840M-L905	LF5OEE-840M-L905	532,00
905	4000K	On/Off	High	3530lm/31W	3,2	LF5OWE-840H-L905	LF5OEE-840H-L905	532,00
1198	4000K	On/Off	Low	2350lm/19W	4,0	LF5OWE-840E-L1198	LF5OEE-840E-L1198	569,00
1198	4000K	On/Off	Medium	3230lm/26W	4,0	LF5OWE-840M-L1198	LF5OEE-840M-L1198	569,00
1198	4000K	On/Off	High	4710lm/40W	4,0	LF5OWE-840H-L1198	LF5OEE-840H-L1198	569,00
1490	4000K	On/Off	Low	2940lm/23W	4,9	LF5OWE-840E-L1490	LF5OEE-840E-L1490	648,00
1490	4000K	On/Off	Medium	4040lm/32W	4,9	LF5OWE-840M-L1490	LF5OEE-840M-L1490	648,00
1490	4000K	On/Off	High	5890lm/49W	4,9	LF5OWE-840H-L1490	LF5OEE-840H-L1490	648,00
1780	4000K	On/Off	Low	3530lm/27W	5,7	LF5OWE-840E-L1780	LF5OEE-840E-L1780	795,00
1780	4000K	On/Off	Medium	4850lm/38W	5,7	LF5OWE-840M-L1780	LF5OEE-840M-L1780	795,00
1780	4000K	On/Off	High	7070lm/59W	5,7	LF5OWE-840H-L1780	LF5OEE-840H-L1780	795,00
2075	4000K	On/Off	Low	4120lm/34W	6,9	LF5OWE-840E-L2075	LF5OEE-840E-L2075	970,00
2075	4000K	On/Off	Medium	5660lm/47W	6,9	LF5OWE-840M-L2075	LF5OEE-840M-L2075	970,00
2075	4000K	On/Off	High	8240lm/71W	6,9	LF5OWE-840H-L2075	LF5OEE-840H-L2075	970,00
per meter	4000K	On/Off	Low	2000lm/15,5W	3,4	LF5OWE-840E-L****	LF5OEE-840E-L****	482,00
per meter	4000K	On/Off	Medium	2750lm/21,7W	3,4	LF5OWE-840M-L****	LF5OEE-840M-L****	482,00
per meter	4000K	On/Off	High	4010lm/33,3W	3,4	LF5OWE-840H-L****	LF5OEE-840H-L****	482,00
per meter	4000K	DALI	Low	2000lm/15,5W	3,4	LF5OWL-840E-L****	LF5OEL-840E-L****	534,00
per meter	4000K	DALI	Medium	2750lm/21,7W	3,4	LF5OWL-840M-L****	LF5OEL-840M-L****	534,00
per meter	4000K	DALI	High	4010lm/33,3W	3,4	LF5OWL-840H-L****	LF5OEL-840H-L****	534,00

Satin Louvre | Direct

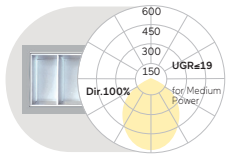

L mm	Colour Temperature	Control	Power	Lumen/Watt	Weight kg	Code Snow White	Code Silver Anodised	CHF
615	4000K	On/Off	Medium	1270lm/15W	2,3	LF5MWE-840M-L615	LF5MEE-840M-L615	506,00
615	4000K	On/Off	High	1840lm/21W	2,3	LF5MWE-840H-L615	LF5MEE-840H-L615	506,00
905	4000K	On/Off	Medium	1900lm/21W	3,2	LF5MWE-840M-L905	LF5MEE-840M-L905	576,00
905	4000K	On/Off	High	2770lm/31W	3,2	LF5MWE-840H-L905	LF5MEE-840H-L905	576,00
1198	4000K	On/Off	Medium	2530lm/26W	4,0	LF5MWE-840M-L1198	LF5MEE-840M-L1198	623,00
1198	4000K	On/Off	High	3690lm/40W	4,0	LF5MWE-840H-L1198	LF5MEE-840H-L1198	623,00
1490	4000K	On/Off	Medium	3170lm/32W	4,9	LF5MWE-840M-L1490	LF5MEE-840M-L1490	685,00
1490	4000K	On/Off	High	4610lm/49W	4,9	LF5MWE-840H-L1490	LF5MEE-840H-L1490	685,00
1780	4000K	On/Off	Medium	3800lm/38W	5,7	LF5MWE-840M-L1780	LF5MEE-840M-L1780	779,00
1780	4000K	On/Off	High	5530lm/59W	5,7	LF5MWE-840H-L1780	LF5MEE-840H-L1780	779,00
2075	4000K	On/Off	Medium	4430lm/47W	6,9	LF5MWE-840M-L2075	LF5MEE-840M-L2075	973,00
2075	4000K	On/Off	High	6450lm/71W	6,9	LF5MWE-840H-L2075	LF5MEE-840H-L2075	973,00

Wallwasher | Direct

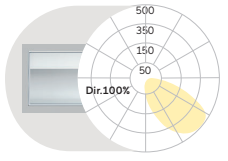

L mm	Colour Temperature	Control	Power	Lumen/Watt	Weight kg	Code Snow White	Code Silver Anodised	CHF
615	4000K	On/Off	High	1180lm/15W	2,4	LF5GWE-840H-L615	LF5GEE-840H-L615	559,00
905	4000K	On/Off	High	1770lm/21W	3,2	LF5GWE-840H-L905	LF5GEE-840H-L905	576,00
1198	4000K	On/Off	High	2360lm/27W	4,1	LF5GWE-840H-L1198	LF5GEE-840H-L1198	623,00
1490	4000K	On/Off	High	2950lm/33W	5,0	LF5GWE-840H-L1490	LF5GEE-840H-L1490	685,00
1780	4000K	On/Off	High	3540lm/39W	5,8	LF5GWE-840H-L1780	LF5GEE-840H-L1780	849,00
2075	4000K	On/Off	High	4130lm/47W	7,0	LF5GWE-840H-L2075	LF5GEE-840H-L2075	1059,00
per meter	4000K	On/Off	High	2010lm/21,9W	3,5	LF5GWE-840H-L****	LF5GEE-840H-L****	508,00
per meter	4000K	DALI	High	2010lm/21,9W	3,5	LF5GWL-840H-L****	LF5GEL-840H-L****	560,00

**** Your length in mm
 Meterpreise für Lichtsysteme nach Maß ab Mindestlänge 2200mm | Prices per metre for customised lighting systems with a minimum length of 2200mm
 Prix au mètre pour systèmes d'éclairage sur mesure à partir d'une longueur minimale de 2200mm



90° Corner
Opal/Microprismatic

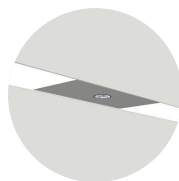

Midpin-Downlight XD
770lm/10W/Ø40mm

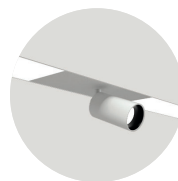

Midpin Spotlight XM
770lm/10W/Ø40mm



Midpoint Spotlight XM
1000lm/19W-3000lm/31W
Ø90mm

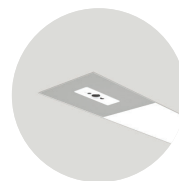

Multisensor

Surcharges

Surface Finish	CHF	Control Gear	CHF L615-L1780	CHF L2075	Colour Rendering	CHF	Colour Temperature	CHF	Additional Options	CHF
W: Snow White	✓	E: On/Off	✓	✓	8: CRI>80	✓	22: 2200K	+5%	90° Corner	0
E: Silver Anodised	✓	L: DALI	+86,00	+172,00	9: CRI>90	+5%	27: 2700K	+5%	Midpin Downlight XD	+363,00
U: Urban Graphite	✓	H: Touch-Dim	+86,00	+172,00	F: Full Spectrum	+15%	30: 3000K	✓	Midpin Spotlight XM	+363,00
B: Jet Black	✓	C: Casambi*	+261,00	+261,00			35: 3500K	+5%	Multisensor [L1198-L2075]	+261,00
H: Anodic Champagne	+10%	6: DALI DT6 for TW	+172,00	+343,00	Lens Louvre*	CHF	40: 4000K	✓	Emergency Module	
K: Satin Copper	+15%	8: DALI DT8 for TW	+172,00	+343,00	W: Snow White	✓	65: 6500K	+5%	[DALI, Autotest, incl. 3H Battery]	+366,00
R: Special RAL/NCS Colours	0				S: Radiant Silver	✓	TW: Tunable White 2700-6500K* [L905-L2075]	+30%		

*Only in combination with DALI. Please add to dimming price.

*Only in combination with DT6, DT8 or Casambi control. Please add additional control price.

✓ standard / no extra charge 0 on request ✗ not available

Höhere Schutzart | Higher Protection |
Indice de Protection SupériCHF



Basic Max A1 IP54 |
Surface
200

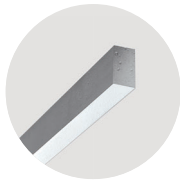

Matric AX IP54 |
System 40mm Surface
200

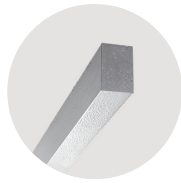

Matric A3 IP54 |
System 55mm Surface
201



Matric FX IP54 | System
40mm Recessed Frame
202



Matric F3 IP54 | System
55mm Recessed Frame
202

Höhere Schutzart | Higher Protection |
Indice de Protection SupériCHF

Basic Max A1 IP54 | Surface

catalogue page 512



Opal Diffuser | Direct

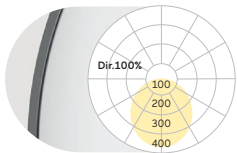

D mm	Colour Temperature	Control	Power	Lumen/Watt	Weight kg	Code Snow White	Code Radiant Silver	CHF
300	4000K	On/Off	Low	910lm/8W	2,2	BA1OWE-840E-D300-IP54	BA1OSE-840E-D300-IP54	569,00
300	4000K	On/Off	Medium	1780lm/14W	2,2	BA1OWE-840M-D300-IP54	BA1OSE-840M-D300-IP54	569,00
400	4000K	On/Off	Low	1790lm/13W	3,5	BA1OWE-840E-D400-IP54	BA1OSE-840E-D400-IP54	779,00
400	4000K	On/Off	Medium	3690lm/29W	3,5	BA1OWE-840M-D400-IP54	BA1OSE-840M-D400-IP54	779,00
500	4000K	On/Off	Low	2550lm/18W	5,7	BA1OWE-840E-D500-IP54	BA1OSE-840E-D500-IP54	926,00
500	4000K	On/Off	Medium	5010lm/35W	5,7	BA1OWE-840M-D500-IP54	BA1OSE-840M-D500-IP54	926,00
600	4000K	On/Off	Low	3980lm/28W	8,9	BA1OWE-840E-D600-IP54	BA1OSE-840E-D600-IP54	1241,00
600	4000K	On/Off	Medium	7470lm/52W	8,9	BA1OWE-840M-D600-IP54	BA1OSE-840M-D600-IP54	1241,00

Surcharges

Surface Finish

Surface Finish	CHF
W: Snow White	✓
V: Ivory White	✓
S: Radiant Silver	✓
U: Urban Graphite	✓
B: Jet Black	✓
H: Anodic Champagne	+10%
K: Satin Copper	+15%
R: Special RAL/NCS Colours	🕒

Control Gear

Control Gear	CHF
E: On/Off	✓
L: DALI	+86,00
H: Touch-Dim	+86,00
C: Casambi*	+261,00
6: DALI DT6 for TW	+172,00
8: DALI DT8 for TW	+172,00

*Only in combination with DALI. Please add to dimming price.

Colour Rendering

Colour Rendering	CHF
8: CRI>80	✓
9: CRI>90	+5%
F: Full Spectrum	+15%

Colour Temperature

Colour Temperature	CHF
22: 2200K	+5%
27: 2700K	+5%
30: 3000K	✓
35: 3500K	+5%
40: 4000K	✓
65: 6500K	+5%
TW: Tunable White 2700-6500K* [D400-D600]	+30%

*Only in combination with DT6, DT8 or Casambi control. Please add additional control price.

✓ standard / no extra charge 🕒 on request ✗ not available

Matric AX IP54 | System 40 mm Surface

catalogue page 516

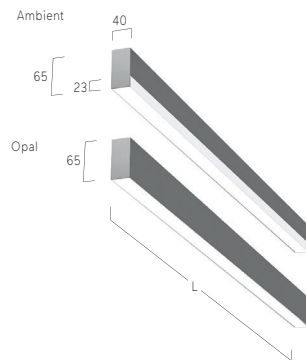

Opal Diffuser | Direct

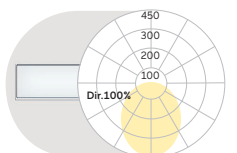

L mm	Colour Temperature	Control	Power	Lumen/Watt	Weight kg	Code Snow White	Code Silver Anodised	CHF
600	4000K	On/Off	Medium	870lm/9W	1,4	LAXOWE-840M-L600-IP54	LAXOEE-840M-L600-IP54	482,00
890	4000K	On/Off	Medium	1300lm/12W	1,9	LAXOWE-840M-L890-IP54	LAXOEE-840M-L890-IP54	508,00
1182	4000K	On/Off	Medium	1730lm/15W	2,4	LAXOWE-840M-L1182-IP54	LAXOEE-840M-L1182-IP54	552,00
1475	4000K	On/Off	Medium	2160lm/19W	2,9	LAXOWE-840M-L1475-IP54	LAXOEE-840M-L1475-IP54	613,00
1765	4000K	On/Off	Medium	2600lm/22W	3,4	LAXOWE-840M-L1765-IP54	LAXOEE-840M-L1765-IP54	692,00
2055	4000K	On/Off	Medium	3030lm/28W	4,2	LAXOWE-840M-L2055-IP54	LAXOEE-840M-L2055-IP54	884,00

Ambient | Direct

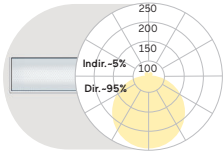

L mm	Colour Temperature	Control	Power	Lumen/Watt	Weight kg	Code Snow White	Code Silver Anodised	CHF
600	4000K	On/Off	Medium	1080lm/9W	1,4	LAXFWE-840M-L600-IP54	LAXFEE-840M-L600-IP54	508,00
890	4000K	On/Off	Medium	1620lm/12W	1,9	LAXFWE-840M-L890-IP54	LAXFEE-840M-L890-IP54	543,00
1182	4000K	On/Off	Medium	2150lm/16W	2,4	LAXFWE-840M-L1182-IP54	LAXFEE-840M-L1182-IP54	604,00
1475	4000K	On/Off	Medium	2690lm/19W	2,9	LAXFWE-840M-L1475-IP54	LAXFEE-840M-L1475-IP54	683,00
1765	4000K	On/Off	Medium	3230lm/22W	3,4	LAXFWE-840M-L1765-IP54	LAXFEE-840M-L1765-IP54	779,00
2055	4000K	On/Off	Medium	3770lm/28W	4,2	LAXFWE-840M-L2055-IP54	LAXFEE-840M-L2055-IP54	980,00

Surcharges

Surface Finish	CHF	Control Gear	CHF L600-L1765	CHF L2055	Colour Temperature	CHF	Lens Louvre*	CHF	Colour Rendering	CHF
W: Snow White	✓	E: On/Off	✓	✓	22: 2200K	+5%	W: Snow White	✓	8: CRI>80	✓
V: Ivory White	✓	L: DALI	+86,00	+172,00	27: 2700K	+5%	A: Satin Silver	✓	9: CRI>90	+5%
S: Silver Anodised	✓	H: Touch-Dim	+86,00	+172,00	30: 3000K	✓	B: Jet Black	✓	F: Full Spectrum	+15%
U: Urban Graphite	✓	C: Casambi* [L890-L2055]	+261,00	+261,00	35: 3500K	+5%	H: Anodic Champagne	✓		
B: Jet Black	✓	6: DALI DT6 for TW [L1182-L2055]	+172,00	+343,00	40: 4000K	✓	K: Satin Copper	✓		
H: Anodic Champagne	+10%	8: DALI DT8 for TW [L890-L2055]	+172,00	+343,00	65: 6500K	+5%	G: Satin Gold	✓		
R: Special RAL/NCS Colours	ⓘ				TW: Tunable White 2700-6500K*	+30%				

*Only in combination with DALI. Please add to dimming price.

*Only in combination with DT6, DT8 or Casambi control. Please add additional control price.

✓ standard / no extra charge ⓘ on request ✗ not available

Matric A3 IP54 | System 55 mm Surface

catalogue page 518

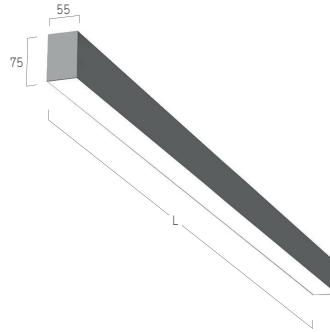

Opal Diffuser | Direct

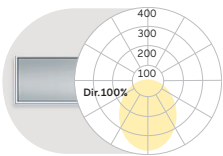

L mm	Colour Temperature	Control	Power	Lumen/Watt	Weight kg	Code Snow White	Code Silver Anodised	CHF
600	4000K	On/Off	Medium	1210lm/12W	1,8	LA3OWE-840M-L600-IP54	LA3OEE-840M-L600-IP54	490,00
890	4000K	On/Off	Medium	1820lm/16W	2,4	LA3OWE-840M-L890-IP54	LA3OEE-840M-L890-IP54	517,00
1182	4000K	On/Off	Medium	2430lm/21W	3,0	LA3OWE-840M-L1182-IP54	LA3OEE-840M-L1182-IP54	560,00
1475	4000K	On/Off	Medium	3030lm/26W	3,7	LA3OWE-840M-L1475-IP54	LA3OEE-840M-L1475-IP54	639,00
1765	4000K	On/Off	Medium	3640lm/30W	4,3	LA3OWE-840M-L1765-IP54	LA3OEE-840M-L1765-IP54	735,00
2055	4000K	On/Off	Medium	4250lm/38W	5,2	LA3OWE-840M-L2055-IP54	LA3OEE-840M-L2055-IP54	919,00

Surcharges

Optical System	CHF	Surface Finish	CHF	Control Gear	CHF L600-L1765	CHF L2055	Colour Rendering	CHF	Colour Temperature	CHF
O: Opal Diffuser (PMMA)	✓	W: Snow White	✓	E: On/Off	✓	✓	8: CRI>80	✓	22: 2200K	+5%
D: Opal Diffuser Polycarbonate*	+5%	V: Ivory White	✓	L: DALI	+86,00	+172,00	9: CRI>90	+5%	27: 2700K	+5%
		E: Silver Anodised	✓	H: Touch-Dim	+86,00	+172,00	F: Full Spectrum	+15%	30: 3000K	✓
		U: Urban Graphite	✓	C: Casambi* [L890-L2055]	+261,00	+261,00			35: 3500K	+5%
		B: Jet Black	✓	6: DALI DT6 for TW [L1182-L2055]	+172,00	+343,00			40: 4000K	✓
		H: Anodic Champagne	+10%	8: DALI DT8 for TW [L890-L2055]	+172,00	+343,00			65: 6500K	+5%
		R: Special RAL/NCS Colours	ⓘ						TW: Tunable White 2700-6500K** [L1182-L2055]	+30%

*Opal Diffuser made of sustainable Trucircle Polycarbonate / Fire Rated - Glow wire flammability Index 950°C EN60695-2-12 / Tp(a). Luminous flux reduction of 10%.

*Only in combination with DALI. Please add to dimming price.

*Only in combination with DT6, DT8 or Casambi control. Please add additional control price.

✓ standard / no extra charge ⓘ on request ✗ not available

Matric FX IP54 | System 40 mm Recessed Frame

catalogue page 520

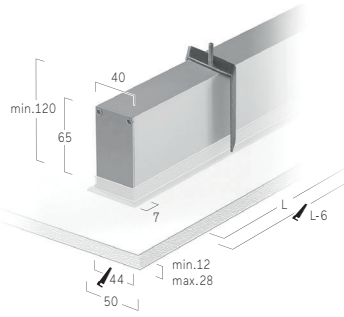
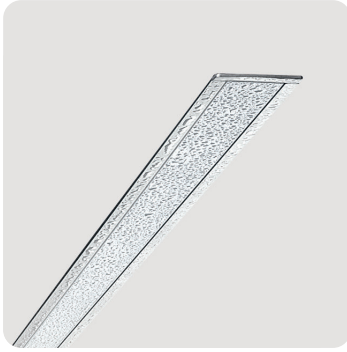

Opal Diffuser | Direct

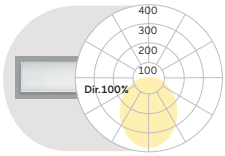

L mm	Colour Temperature	Control	Power	Lumen/Watt	Weight kg	Code Snow White	Code Silver Anodised	CHF
610	4000K	On/Off	Medium	870lm/9W	1,5	LFXOWE-840M-L610-IP54	LFXOEE-840M-L610-IP54	534,00
900	4000K	On/Off	Medium	1300lm/12W	2,0	LFXOWE-840M-L900-IP54	LFXOEE-840M-L900-IP54	560,00
1192	4000K	On/Off	Medium	1730lm/15W	2,5	LFXOWE-840M-L1192-IP54	LFXOEE-840M-L1192-IP54	604,00
1485	4000K	On/Off	Medium	2160lm/19W	3,0	LFXOWE-840M-L1485-IP54	LFXOEE-840M-L1485-IP54	665,00
1775	4000K	On/Off	Medium	2600lm/22W	3,5	LFXOWE-840M-L1775-IP54	LFXOEE-840M-L1775-IP54	744,00
2065	4000K	On/Off	Medium	3030lm/28W	4,4	LFXOWE-840M-L2065-IP54	LFXOEE-840M-L2065-IP54	937,00

Surcharges

Surface Finish

Surface Finish	CHF
W: Snow White	✓
V: Ivory White	✓
S: Silver Anodised	✓
U: Urban Graphite	✓
B: Jet Black	✓
H: Anodic Champagne	+10%
R: Special RAL/NCS Colours	ⓘ

Control Gear

Control Gear	CHF L600-L1765	CHF L2055
E: On/Off	✓	✓
L: DALI	+86,00	+172,00
H: Touch-Dim	+86,00	+172,00
C: Casambi* [L910-L2065]	+261,00	+261,00
G: DALI DT6 for TW	+172,00	+343,00
8: DALI DT8 for TW	+172,00	+343,00

Colour Rendering

Colour Rendering	CHF
8: CRI>80	✓
9: CRI>90	+5%
F: Full Spectrum	+15%

Colour Temperature

Colour Temperature	CHF
22: 2200K	+5%
27: 2700K	+5%
30: 3000K	✓
35: 3500K	+5%
40: 4000K	✓
65: 6500K	+5%
TW: Tunable White 2700-6500K* [L1182-L2055]	+30%

*Only in combination with DALI. Please add to dimming price.

*Only in combination with DT6, DT8 or Casambi control. Please add additional control price.

✓ standard / no extra charge ⓘ on request ✗ not available

Matric F3 IP54 | System 55 mm Recessed Frame

catalogue page 522

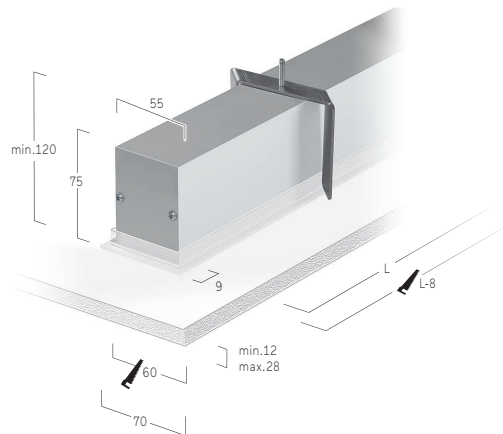
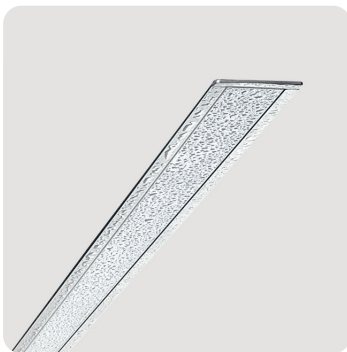

Opal Diffuser | Direct

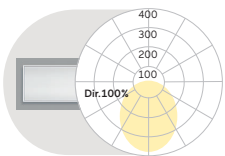

L mm	Colour Temperature	Control	Power	Lumen/Watt	Weight kg	Code Snow White	Code Silver Anodised	CHF
615	4000K	On/Off	Medium	1210lm/12W	1,7	LF3OWE-840M-L615-IP54	LF3OEE-840M-L615-IP54	543,00
905	4000K	On/Off	Medium	1820lm/16W	2,4	LF3OWE-840M-L905-IP54	LF3OEE-840M-L905-IP54	569,00
1198	4000K	On/Off	Medium	2430lm/21W	3,0	LF3OWE-840M-L1198-IP54	LF3OEE-840M-L1198-IP54	613,00
1490	4000K	On/Off	Medium	3030lm/26W	3,7	LF3OWE-840M-L1490-IP54	LF3OEE-840M-L1490-IP54	692,00
1780	4000K	On/Off	Medium	3640lm/30W	4,3	LF3OWE-840M-L1780-IP54	LF3OEE-840M-L1780-IP54	788,00
2075	4000K	On/Off	Medium	4250lm/38W	5,2	LF3OWE-840M-L2075-IP54	LF3OEE-840M-L2075-IP54	972,00

Surcharges

Surface Finish	CHF	Control Gear	CHF L615-L1780	CHF L2075	Colour Rendering	CHF	Colour Temperature	CHF
W: Snow White	✓	E: On/Off	✓	✓	8: CRI>80	✓	22: 2200K	+5%
V: Ivory White	✓	L: DALI	+86,00	+172,00	9: CRI>90	+5%	27: 2700K	+5%
E: Silver Anodised	✓	H: Touch-Dim	+86,00	+172,00	F: Full Spectrum	+15%	30: 3000K	✓
U: Urban Graphite	✓	C: Casambi*	+261,00	+261,00			35: 3500K	+5%
B: Jet Black	✓	6: DALI DT6 for TW [L1198-L2075]	+172,00	+343,00			40: 4000K	✓
H: Anodic Champagne	+10%	8: DALI DT8 for TW [L905-L2075]	+172,00	+343,00			65: 6500K	+5%
R: Special RAL/NCS Colours	🚫						TW: Tunable White 2700-6500K*	+30%

*Only in combination with DALI. Please add to dimming price.

*Only in combination with DT6, DT8 or Casambi control. Please add additional control price.

✓ standard / no extra charge
🚫 on request
🚫 not available

Appendix | Appendix | Annexe

Suspensions

CORD-HOLDER TYPE-B:



COLOUR	CODE	CHF
NICKEL PLATED	U-BBC	9,00
NO HEIGHT REGULATION		

CORD-HOLDER TYPE-D:



COLOUR	CODE	CHF
NICKEL PLATED	U-BDN	9,00
FOR SLOPING CEILINGS / NO HEIGHT REGULATION		

POWER SUPPLY CABLE:



TYPE	CODE	CHF
3x0,75 MM ² , TRANSPARENT	U-KAB3.....	9,00/M
5x0,75 MM ² , TRANSPARENT	U-KAB5.....	11,00/M
7x0,75 MM ² , TRANSPARENT	U-KAB7.....	16,00/M
RED AND BLACK INSULATION ON REQUEST +30,00		

CEILING ROSE TYPE-A:

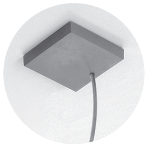

COLOUR	CODE	CHF
SNOW WHITE	U-PAW	49,00
RADIANT SILVER	U-PAS	49,00
105x105x22MM, SURFACE MOUNTED. FOR SUPPLY CABLE (PLEASE ORDER SEPARATELY). STANDARD FOR: CUBIC, MATRIC, VISION		

CEILING ROSE TYPE-C:

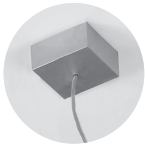

COLOUR	CODE	CHF
SNOW WHITE	U-PCW	49,00
RADIANT SILVER	U-PCS	49,00
82x82x40MM, SURFACE MOUNTED. FOR 7-CORE SUPPLY CABLE (PLEASE ORDER SEPARATELY)		

CEILING ROSE TYPE-E:



COLOUR	CODE	CHF
SNOW WHITE	U-PEW	49,00
RADIANT SILVER	U-PES	49,00
105x105x22MM, SURFACE MOUNTED. FOR SUPPLY CABLE (PLEASE ORDER SEPARATELY). STANDARD FOR: LIQUID LINE, CALEO		

CEILING ROSE TYPE-R:



COLOUR	CODE	CHF
SNOW WHITE	U-PRW	49,00
RADIANT SILVER	U-PRS	49,00
Ø129x22MM, SURFACE MOUNTED. FOR SUPPLY CABLE (PLEASE ORDER SEPARATELY). STANDARD FOR: RINGO STAR, BASIC, CODE ZERO, BEAM ME UP WITH PARALLEL SUSPENSION		

CEILING ROSE TYPE-O:



COLOUR	CODE	CHF
SNOW WHITE	U-POW	49,00
RADIANT SILVER	U-POS	49,00
Ø129x22MM, SURFACE MOUNTED. FOR THREE CORDS & SUPPLY CABLE (PLEASE ORDER SEPARATELY). STANDARD FOR: BASIC-SUPERFLAT, BASIC NEO, BASIC DÉCO WITH CENTRAL SUSPENSION		

CEILING ROSE TYPE-G:



COLOUR	CODE	CHF
SNOW WHITE	U-PGW	63,00
RADIANT SILVER	U-PGS	63,00
Ø140/Ø115x34MM, SURFACE MOUNTED FOR SUPPLY CABLE (PLEASE ORDER SEPARATELY)		

CORD-HOLDER TYPE-C:



COLOUR	CODE	CHF
NICKEL PLATED	U-BCN	9,00
WITH HEIGHT REGULATION		

STEEL CORD:



LENGTH	CODE	CHF
1500 MM	U-LL1500	9,00
3000 MM	U-LL3000	11,00
4000 MM	U-LL4000	13,00
1.5 MM STEEL CORD, ONE-SIDED WITH BUFFER		

CEILING ROSE TYPE-X:

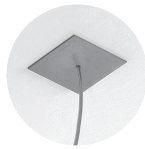

COLOUR	CODE	CHF
SNOW WHITE	U-PXW	35,00
RADIANT SILVER	U-PXS	35,00
80x80x2MM, FOR RECESSED INSTALLATION		

CEILING ROSE TYPE-B:

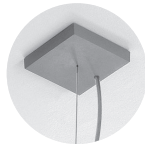

COLOUR	CODE	CHF
SNOW WHITE	U-PBW	49,00
RADIANT SILVER	U-PBS	49,00
105x105x22MM, SURFACE MOUNTED FOR CORD & SUPPLY CABLE (PLEASE ORDER SEPARATELY)		

CEILING ROSE TYPE-D:

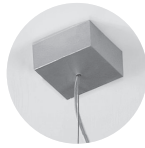

COLOUR	CODE	CHF
SNOW WHITE	U-PDW	49,00
RADIANT SILVER	U-PDS	49,00
82x82x40MM, SURFACE MOUNTED. FOR CORD & 7-CORE SUPPLY CABLE (PLEASE ORDER SEPARATELY)		

CEILING ROSE TYPE-F:



COLOUR	CODE	CHF
SNOW WHITE	U-PFW	49,00
RADIANT SILVER	U-PFS	49,00
105x105x22MM, SURFACE MOUNTED. FOR CORD & SUPPLY CABLE (PLEASE ORDER SEPARATELY)		

CEILING ROSE TYPE-S:



COLOUR	CODE	CHF
SNOW WHITE	U-PSW	49,00
RADIANT SILVER	U-PSS	49,00
Ø129x22MM, SURFACE MOUNTED. FOR ONE CORD & SUPPLY CABLE (PLEASE ORDER SEPARATELY)		

CEILING ROSE TYPE-U:



COLOUR	CODE	CHF
SNOW WHITE	U-PUW	81,00
RADIANT SILVER	U-PUS	81,00
Ø190/Ø150x34MM, SURFACE MOUNTED FOR FOUR CORDS & SUPPLY CABLE (PLEASE ORDER SEPARATELY) STANDARD FOR: RINGO STAR WITH CENTRAL SUSPENSION		

CEILING ROSE TYPE-T:



COLOUR	CODE	CHF
SNOW WHITE	U-PTW	70,00
RADIANT SILVER	U-PTS	70,00
Ø140/Ø115x34MM, SURFACE MOUNTED FOR THREE CORDS & SUPPLY CABLE (PLEASE ORDER SEPARATELY). STANDARD FOR: BASIC MAX, BEAM ME UP, BASIC DÉCO XXL WITH CENTRAL SUSPENSION		

Surface Design



W Snow White (RAL 9003)



V Ivory White (RAL 9010)

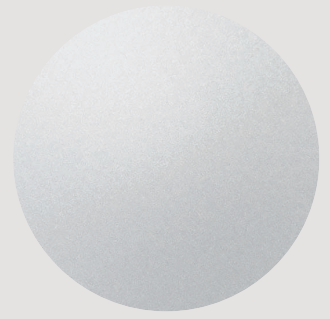

E Silver Anodised

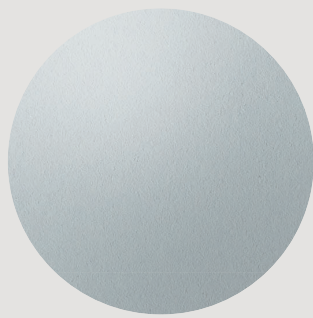

Light Grey



S Radiant Silver (RAL9006)



H Anodic Champagne



U Urban Graphite

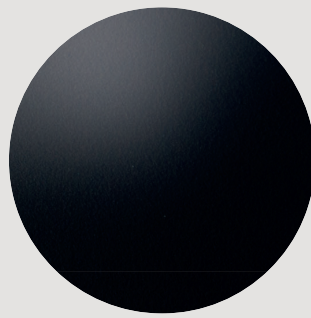

B Jet Black (RAL 9005)



Burnished Steel

DE Die Lightnet Surface Collection besteht aus 18 ausgewählten hochwertigen und architekturelevanten Oberflächendesigns. Hierbei werden unterschiedliche handwerkliche und industrielle Techniken verwendet, die weit über eine bloße Farbgebung nach RAL hinausreichen. So satinieren wir z.B. Oberflächen und verwenden liquide Metalle und Beton. Sollte die jeweilige Wunsch-Oberfläche nicht im Konfigurations-Tableau auf der Produktseite aufgeführt sein, kann diese gesondert angefragt werden. Darüber hinaus bieten wir unsere gesamte Leuchtenkollektion auch im Sonderfarbton Ihrer Wahl nach RAL/NCS an.

EN The Lightnet Surface Collection consists of eighteen high-quality and architecturally relevant surface designs. We use a variety of craftsmanship and industrial techniques that go far beyond mere RAL colouring. For example, we satin finish surfaces and use liquid metals and concrete. If the respective desired surface is not listed in the configuration table on the product page, it can be requested separately. In addition, we also offer our entire luminaire collection in the RAL/NCS colour of your choice.



A Satin Silver



Satin Platinum



G Satin Gold

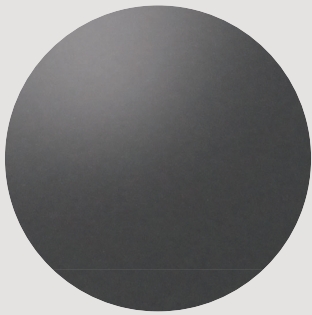

Iron Grey



K Satin Copper

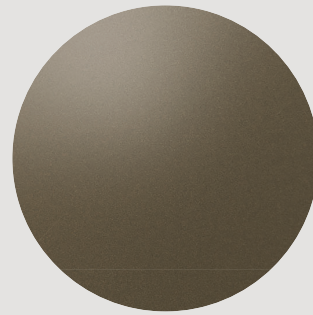

Medium Brass



Ash Concrete



Stalwart Rust



Architectural Bronze

Colour Temperature



DE Nahezu unser gesamtes Sortiment ist in den Lichtfarben 2200K, 2700K, 3000K, 3500K, 4000K und 6500K erhältlich. Auf Anfrage sind auch weitere Sonderlichtfarben möglich. Für ca. 80% unserer Produkte haben wir Tunable-White-Lösungen entwickelt. Hierbei kann die Lichtfarbe von 2700K bis 6500K stufenlos eingestellt werden. In Verbindung mit HCL-Control kann die Lichtfarbe und Lichtintensität im Tagesablauf dynamisch verändert werden und so Human Centric Konzepte umgesetzt werden. Bitte beachten Sie, dass sich alle Lichtstromangaben in diesem Katalog auf eine Referenzmessung mit Farbtemperatur 4000K beziehen. Korrekturfaktoren für andere Lichtfarben stellen wir für das jeweilige Produkt auf Anfrage zur Verfügung.

EN Almost our entire range is available in the following colour temperatures 2200K, 2700K, 3000K, 3500K, 4000K and 6500K. Other special light colours are also available on request. We have developed Tuneable White solutions for approx. 80% of our products. Here, the light colour can be continuously adjusted from 2700K to 6500K. In combination with HCL-Control, the light colour and light intensity can be changed dynamically during the course of the day and thus Human Centric Lighting concepts can be implemented. Please note that all luminous flux specifications in this catalogue refer to a reference measurement with colour temperature 4000K. Correction factors for other light colours are available for the respective product on request.

Colour Rendering

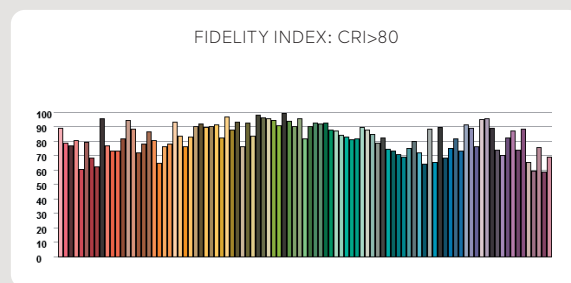
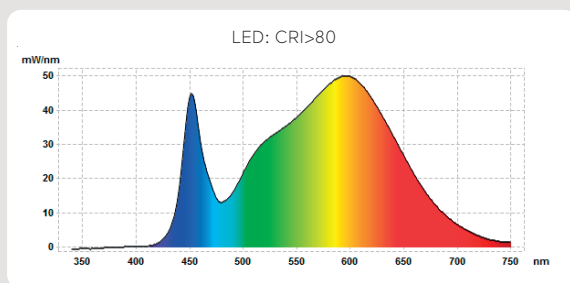
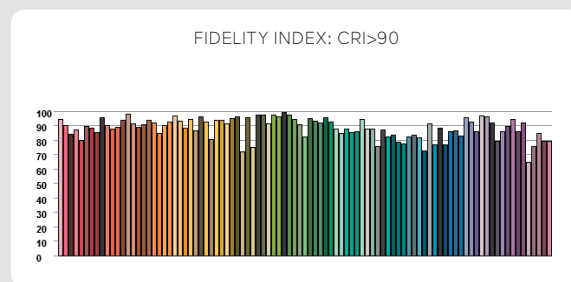
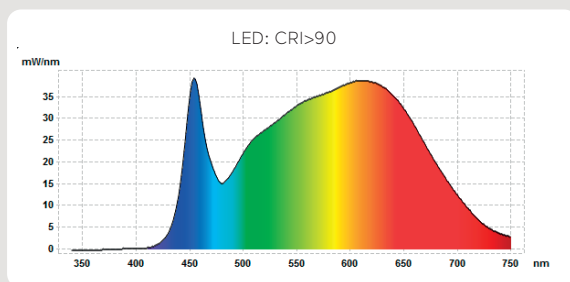
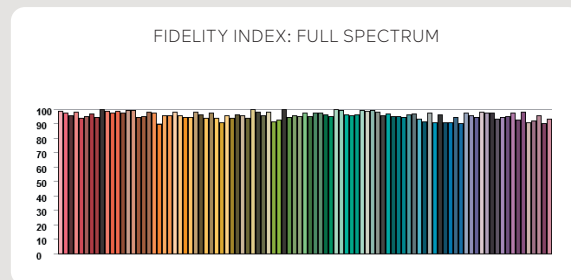
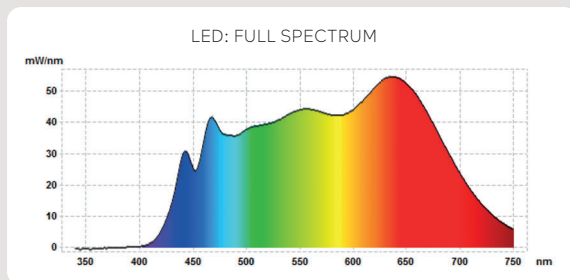

DE Produktübergreifend bieten wir nahezu unser gesamte Leuchtenkollektion in den Farbwiedergabestufen CRI>80, CRI>90 und Full Spectrum an (Serie Midpin und Midpoint nur CRI>90). Die Farbwiedergabestufe Full Spectrum bildet dabei das Lichtspektrum des Sonnenlichts nach. Auf diese Weise hat sie positiven Einfluss auf die Gesundheit des Menschen und garantiert lebendige Farben und starke Kontraste. Auf Anfrage stellen wir für eine genauere Einschätzung der Farbwiedergabeeigenschaften je Produkt den Fidelity-Index gemäß TM-30-15 zur Verfügung. Bitte beachten Sie, dass sich alle Lichtstromangaben in diesem Katalog auf eine Referenzmessung mit Farbwiedergabe CRI>80 (Midpin&Midpoint CRI>90) beziehen. Korrekturfaktoren für andere Farbwiedergabestufen stellen wir für das jeweilige Produkt auf Anfrage zur Verfügung.

EN We offer almost our entire luminaire collection with CRI>80, CRI>90 and Full Spectrum colour rendering (Midpin and Midpoint series only CRI>90). Full Spectrum reproduces the light spectrum of sunlight. In this way, it has a positive influence on human health and guarantees vivid colours and strong contrasts. For a more precise assessment of the colour rendering properties of each product, we can provide the Fidelity Index according to TM-30-15 on request. Please note that all luminous flux data in this catalogue refers to a reference measurement with colour rendering CRI>80 (Midpin&Midpoint CRI>90). Correction factors for other colour rendering levels are available for the respective product on request.

Multisensor

General product description (short version)

Option 1: Automatic mode

Luminaire turns itself on/off, automatic daylight and motion control

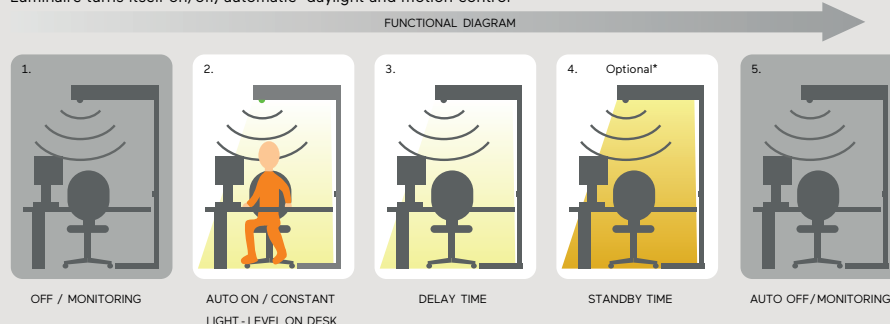

Option 2: Semi-Automatic mode (optional)

Luminaire always switched on /off manually, automatic daylight and motion control

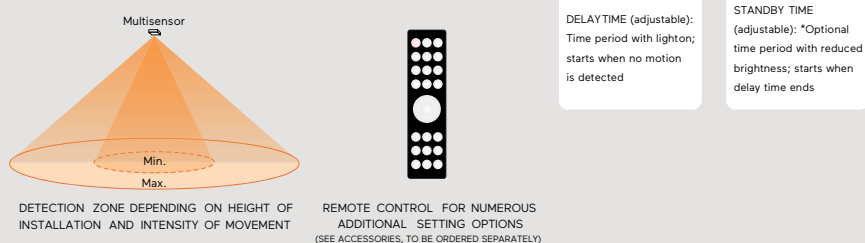
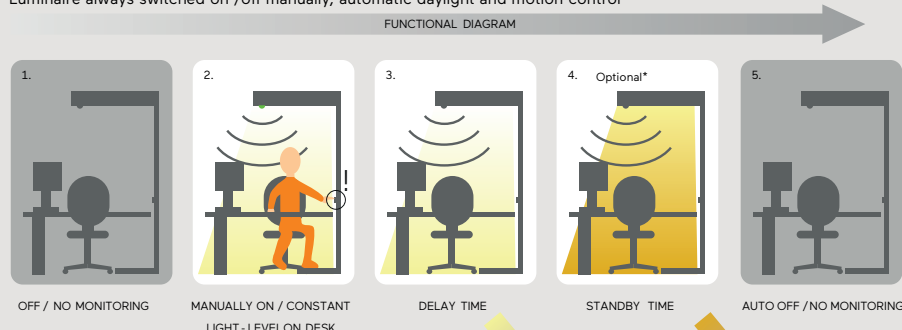

DE Multisensor bestehend aus einem PIR-Bewegungssensor (Passiv-Infrarot) und einem Lichtfühler. Sämtliche Sensorkomponenten in Leuchtenkorpus integriert. Das System ist konzipiert für individuell gesteuerte Leuchten, die nicht an ein Gebäudeleitsystem angeschlossen sind. Im vollautomatischen Modus schaltet der Multisensor die Leuchte bei Präsenzerkennung an, reguliert die Lichtintensität gemäß des Umgebungslichts und schaltet die Leuchte bei fehlender Präsenzerfassung mit einstellbarer Zeitverzögerung aus. Das System kann zusätzlich per Drucktaster (drahtgebunden; sowohl in externer Ausführung als auch direkt in Leuchte integriert), per Funktaster oder über eine Smartphone-/ Tablet-Anwendung manuell angesteuert werden. Typische konfigurierbare Zusatzfunktionen: Halbautomatischer Betrieb (manuelles Einschalten der Leuchte, anschließende automatische Regulierung der Lichtintensität und Abschaltung), zweistufige Abschaltung bei fehlender Präsenz sowie verschiedene Gruppenfunktionen (drahtlose Verbindung mit anderen Leuchten). Vielzahl weiterer Sensorfunktionen- und Programmierungen über eine per Zubehörprogramm bestellbare Fernbedienung oder per Smartphone-/ Tablet-Anwendung. Weitere technische Details siehe Bedienungsanleitung oder auf Anfrage.

EN Our Multi-sensors consist of a PIR motion sensor (passive infrared) and a light sensor. All sensor components are integrated in the luminaire body. The system is designed for individually controlled luminaires that are not connected to a building management system. In fully automatic mode, the multi-sensor switches the luminaire on when presence is detected, regulates the light intensity according to the ambient light and switches the luminaire off with an adjustable time delay if presence is not detected. The system can also be controlled manually via push-button (wired; both in external version and directly integrated in luminaire), via wireless push-button or via smartphone/tablet application. Typical configurable additional functions: Semi-automatic operation (manual switch-on of luminaire, subsequent automatic regulation of light intensity and switch-off), two-stage switch-off in the absence of presence and various group functions (wireless connection with other luminaires). Numerous other sensor functions and programming via a remote control that can be ordered from the accessories range or via smartphone/tablet application. For further technical details see operating instructions or on request.

Radar Sensor

General product description (short version)

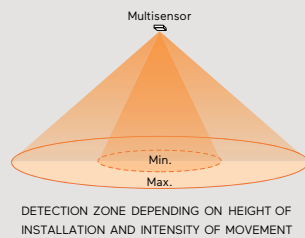
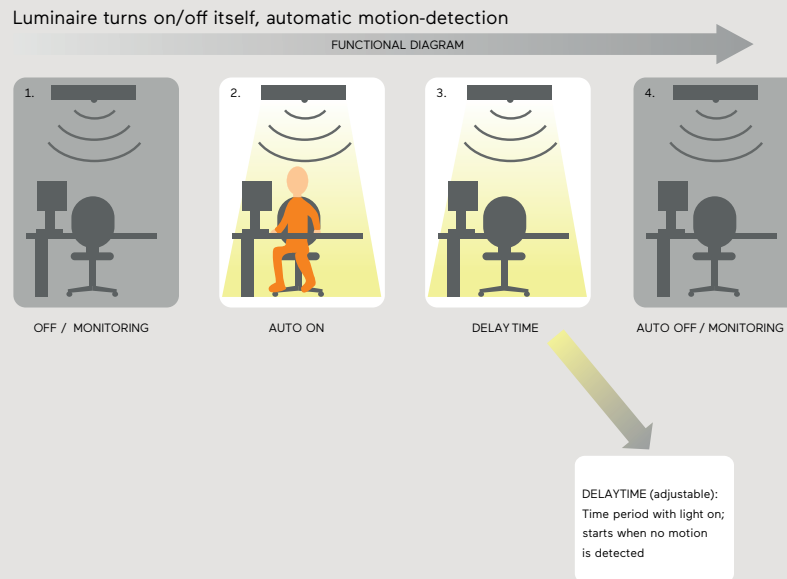

DE Radar Sensor bestehend aus einem Bewegungssensor in Hochfrequenz-Technologie im Mikrowellenfrequenzbereich und einem Steuergerät. Sämtliche Sensorkomponenten in Leuchtenkorpus integriert. Das System ist konzipiert für individuell gesteuerte Leuchten und Master-/Slave-Kombinationen, die nicht an ein Gebäudeleitsystem angeschlossen sind. Die Hauptaufgabe des Radar-Sensors besteht darin, die Leuchte bei Präsenzerkennung einzuschalten und bei fehlender Bewegungserkennung mit einstellbarer Zeitverzögerung auszuschalten. Weiter besteht die Möglichkeit, einen Schwellenwert für die umgebende Lichtintensität zu definieren, bei dessen Überschreitung der Sensor die Leuchte nicht mehr einschaltet. Die Konfiguration des Sensors erfolgt über DIP-SWITCH oder Drehknöpfe am Steuergerät. Weitere technische Details siehe Bedienungsanleitung oder auf Anfrage.

EN Radar sensor consisting of a motion sensor in high-frequency technology in the microwave frequency range and a control unit. All sensor components integrated in luminaire body. The system is designed for individually controlled luminaires and master/slave combinations that are not connected to a building management system. The main task of the radar sensor is to switch on the luminaire when presence is detected and to switch it off with an adjustable time delay when motion is not detected. Furthermore, it is possible to define a threshold value for the ambient light intensity, above which the sensor will no longer switch on the luminaire. The sensor is configured via DIP-SWITCH or rotary knobs on the control unit. For further technical details, see the operating instructions or contact us.

Swarm Control

General product description (short version)

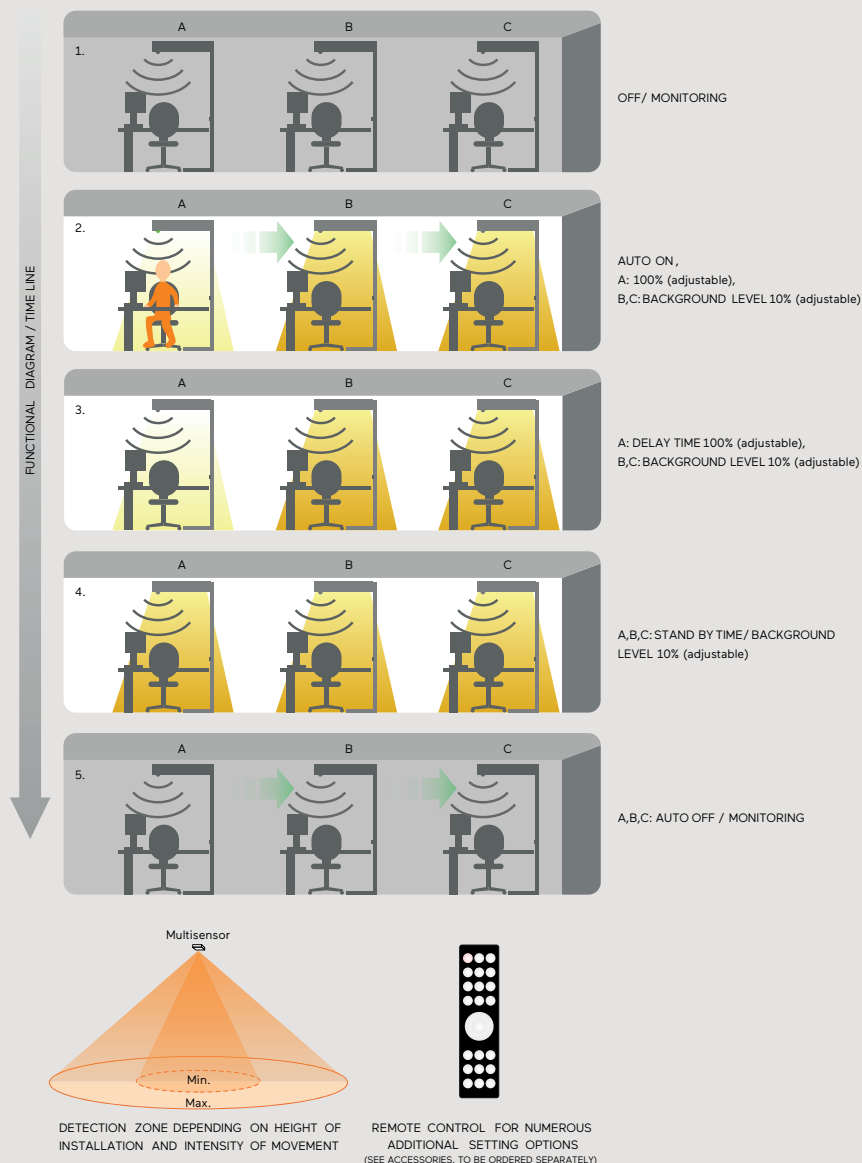

DE Swarm Control bestehend aus einem PIR-Bewegungssensor (Passiv-Infrarot) und einem Lichtfühler. Sämtliche Sensorkomponenten in Leuchtenkorpus integriert. Das System ist konzipiert für individuell gesteuerte Leuchten, die nicht an ein Gebäudeleitsystem angeschlossen sind. Die Hauptanwendung von Swarm-Control findet sich in Open-Office-Büros. Ziel ist es, einen abrupten Übergang von hell zu dunkel aufgrund unbesetzter Arbeitsbereiche zu vermeiden und das Wohlbefinden über sanft ausgeleuchtete Hintergrundbereiche zu fördern. Die Präsenz erfassende Leuchte arbeitet im vollautomatischen Modus, d.h. der Multisensor schaltet die Leuchte an, reguliert die Lichtintensität gemäß des Umgebungslichts und schaltet die Leuchte bei fehlender Präsenzerfassung mit einstellbarer Zeitverzögerung aus. Gleichzeitig schaltet der Sensor die Leuchten seines Schwarms hinzu, eine Gruppe festgelegter Leuchten. Diese Leuchten arbeiten in zuvor definierter, reduzierter Lichtintensität und schalten zeitverzögert bei fehlender Präsenzerkennung des Schwarms ab. Die Kommunikation innerhalb eines Schwarms erfolgt drahtlos. Je nach Ausführung wird das Swarm-Control System über eine Smartphone-/Tablet-Anwendung oder mittels einer per Zubehörprogramm bestellbaren Fernbedienung konfiguriert. Weitere technische Details siehe Bedienungsanleitung oder auf Anfrage.

EN Swarm Control consisting of a PIR motion sensor (passive infrared) and a light sensor. All sensor components are integrated in the luminaire body. The system is designed for individually controlled luminaires that are not connected to a building management system. The main application of Swarm-Control is in open-office environments. The aim is to avoid an abrupt transition from light to dark due to unoccupied work areas and to promote well-being via softly illuminated background areas. The presence-detecting luminaire operates in fully automatic mode, i.e. the multi-sensor switches the luminaire on, regulates the light intensity according to the ambient light and switches the luminaire off with an adjustable time delay if presence is not detected. At the same time, the sensor switches on the luminaires of its swarm, a group of defined luminaires. These luminaires operate at a previously defined, reduced light intensity and switch off with a time delay if the swarm fails to detect presence. Communication within a swarm is wireless. Depending on the version, the Swarm-Control system is configured via a smartphone/tablet application or by means of a remote control that can be ordered from the range of accessories. For further technical details, please see the operating instructions or contact us.

HCL-Control

General product description (short version)

Luminaire turns itself ON/OFF, automatic daylight and motion control

FUNCTIONAL DIAGRAM

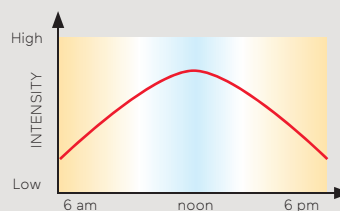
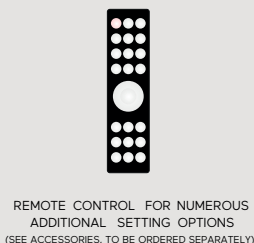
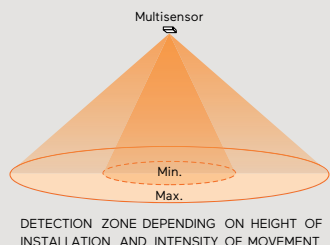
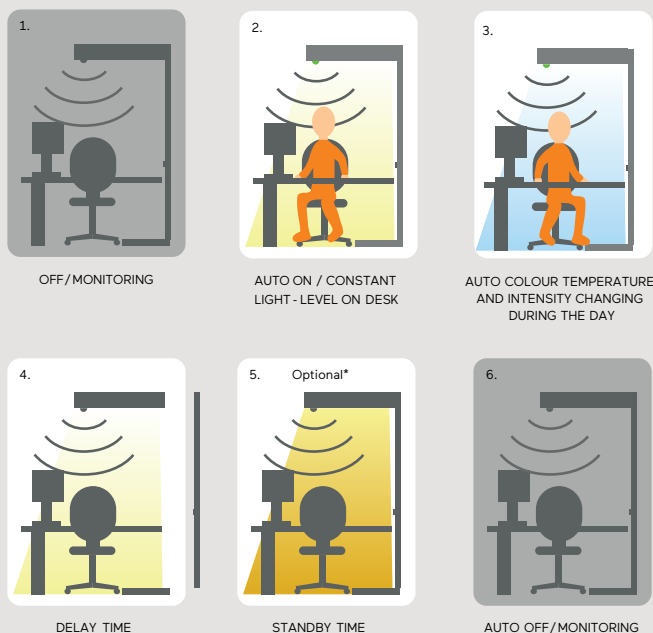

DE HCL-Control (Human-Centric-Control) für Tunable White Leuchten bestehend aus einem PIR-Bewegungssensor (Passiv Infrarot) und einem Lichtsensor. Sämtliche Sensorkomponenten in Leuchtenkorpus integriert. Das System ist konzipiert für individuell gesteuerten Leuchten, die nicht an ein Gebäudeleitsystem angeschlossen sind. Ziel ist es, auch in Situationen und/oder Phasen geringer Tageslichtversorgung dem inneren Rhythmus einen Tageslicht-Abgleich zu ermöglichen und die biologischen Prozesse zu steuern. So, wie sich das Licht im Laufe des Tages ändert, so passen sich Leuchten mit HCL-Control gemäß eines zuvor programmierbaren Algorithmus in Lichtfarbe und Beleuchtungsstärke dynamisch dem Tageslichtverlauf an. Zusätzlich schaltet der Multisensor die Leuchte im vollautomatischen Modus bei Präsenzerkennung an, reguliert die Lichtintensität gemäß des Umgebungslichts und schaltet die Leuchte bei fehlender Präsenzerfassung mit einstellbarer Zeitverzögerung aus. Das System kann per Drucktaster (drahtgebunden; sowohl in externer Ausführung als auch direkt in Leuchte integriert), per Funktaster oder über eine Smartphone-/ Tablet-Anwendung manuell angesteuert werden. HCL-Control wird über eine Smartphone-/Tablet-Anwendung konfiguriert. Weitere technische Details siehe Bedienungsanleitung oder auf Anfrage.

EN HCL Control (Human-Centric Lighting Control) for Tuneable White luminaires consisting of a PIR (Passive Infrared) motion sensor and a light sensor. All sensor components are integrated in the luminaire body. The system is designed for individually controlled luminaires that are not connected to a building management system. The aim is to provide daylight balance to the inner rhythm even in situations and/or phases of low daylight supply and to control biological processes. Just as light changes during the course of the day, luminaires with HCL-Control dynamically adapt to the course of daylight in terms of light colour and illuminance according to a previously programmable algorithm. In addition, the multi-rev iksensor switches the luminaire on in fully automatic mode when presence is detected, regulates the light intensity according to the ambient light and switches the luminaire off with an adjustable time delay when presence is not detected. The system can be controlled manually by push-button (wired; both in external version and directly integrated in luminaire), by wireless push-button or via a smartphone/tablet application. HCL-Control is configured via a smartphone/tablet application. For further technical details, see operating instructions or on request.

Emergency Light

General product description (short version)

Option 1: Built in battery pack

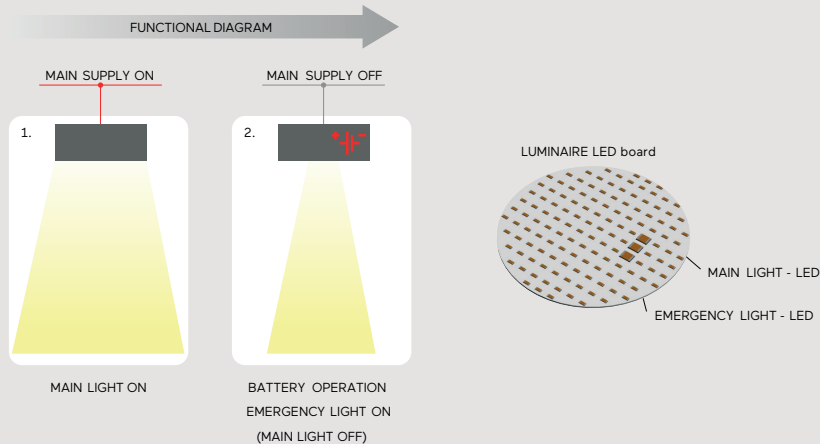

Option 2: External central battery

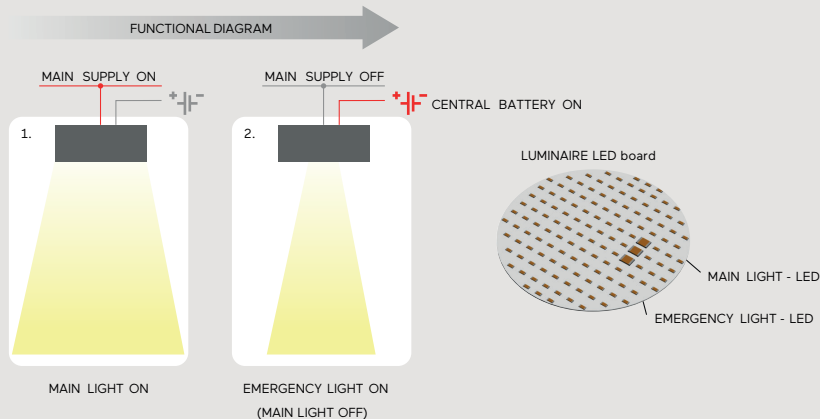

DE Notlichtmodul bestehend aus einem Steuermodul, einer 3h-Batterie und einer Notlichtquelle. Sämtliche Komponenten in Leuchtenkorpus integriert Die Notlichtquelle besteht aus zusätzlichen LED-Chips, die im Normalbetrieb nicht sichtbar sind (in einigen Fällen kann die Hauptlichtquelle ganz oder teilweise anstelle der zusätzlichen Notlichtquelle verwendet werden). Das Steuermodul überwacht den Zustand der Hauptstromversorgung und schaltet bei deren Ausfall die zusätzliche Notlichtquelle ein, die von der eingebauten Batterie gespeist wird. Wird die Hauptstromversorgung wieder eingeschaltet, schaltet das Modul die Notlichtquelle ab und beginnt mit der Wiederaufladung der Batterie. Die Überwachung des Batterieverbrauchs und der Effizienz der Lichtquelle erfolgt automatisch (Selbsttest). Die Kombination der Möglichkeiten der Selbsttestfunktion mit der Fernsteuerung über einen zentralen DALI-Controller ist möglich. Details siehe Bedienungsanleitung. Auf gesonderte Anfrage ist die Integration von Steuermodulen für eine zentrale Batterieversorgung möglich.

EN Emergency light module consisting of a control module, a 3h battery and an emergency light source. All components integrated in luminaire body The emergency light source consists of additional LED chips that are not visible during normal operation (in some cases, the main light source can be used completely or partially instead of the additional emergency light source). The control module monitors the status of the main power supply and, in the event of its failure, switches on the additional emergency light source, which is powered by the built-in battery. When the main power supply is switched on again, the module switches off the emergency light source and starts recharging the battery. Monitoring of battery consumption and light source efficiency is automatic (self-test). Combining the possibilities of the self-test function with remote control via a central DALI controller is possible. For details, see operating instructions. On separate request, the integration of control modules for a central battery supply is possible.

AGB – Allgemeine Geschäftsbedingungen

1. Anwendungsbereich und Geltung

- 1.1 Diese allgemeinen Geschäftsbedingungen (AGB) gelten, soweit ihnen nicht zwingende gesetzliche Vorschriften entgegenstehen, für sämtliche Rechtsbeziehungen zwischen der Mabalux AG, CH-4657 Dulliken und ihren Kunden im Rahmen der nachfolgend umschriebenen Tätigkeitsbereiche:
- Verkauf von Leuchten, Leuchtcomponenten und Leuchtmitteln aller Art und damit zusammenhängendem Zubehör
 - Lieferungen von Verkaufsgegenständen und eine allfällige Montage derselben
 - Erbringung von Servicedienstleistungen aller Art, namentlich Projektdienstleistungen, Kundendienstleistungen oder Wartungsdienstleistungen
- 1.2 Diese AGB bilden einen integrierenden Bestandteil der in Ziffer 1.1 beschriebenen Rechtsbeziehungen, sofern nicht explizit etwas anderes vereinbart wird. Davon abweichende Bestimmungen erlangen nur Rechtsverbindlichkeit, wenn sie von der Mabalux AG ausdrücklich und schriftlich offeriert oder akzeptiert werden.
- 1.3 Mit dem Eingehen einer Rechtsbeziehung mit der Mabalux AG, namentlich dem Abschluss eines Vertrages, akzeptiert und erklärt sich der Kunde damit einverstanden, dass die Rechtsbeziehung durch diese AGB geregelt wird.
- 1.4 Allgemeine Geschäftsbedingungen und/oder ähnliche Dokumente des Kunden, wie etwa Einkaufs- oder Submissionsbestimmungen oder Abänderungen dieser AGB, sind explizit wegbedungen und ausgeschlossen, sofern die Mabalux AG ihnen nicht ausdrücklich schriftlich zustimmt. Dies gilt auch dann, wenn allgemeine Geschäftsbedingungen und/oder ähnliche Dokumente des Kunden einer Bestellung oder „Auftragsbestätigung“ beigelegt oder der Mabalux AG anderweitig mitgeteilt worden sind.

2. Angebot und Preise

- 2.1 Angebote der Mabalux AG erfolgen, sofern ihre Gültigkeitsdauer nicht ausdrücklich vermerkt ist, freibleibend und unter Vorbehalt des Zwischen-verkaufs.
- 2.2 Alle Leuchtenpreise verstehen sich exklusive Leuchtmittel, Transportkosten und Verpackung. Ausnahmen sind entsprechend vermerkt.
- 2.3 Die Mabalux AG behält sich vor, sämtliche Preise jederzeit zu ändern.
- 2.4 Die Produktpreise beinhalten keine Installation oder Montage der Produkte und sind exklusive Mehrwertsteuer zu verstehen.
- 2.5 An allen Zeichnungen, Entwürfen, Kostenvoranschlägen, Lichtplanungen, Angeboten und anderen Unterlagen behält sich die Mabalux AG das Eigentums- und Urheberrecht vor. Diese Unterlagen werden dem Empfänger persönlich anvertraut und dürfen ohne schriftliche Genehmigung der Mabalux AG weder Dritten zugänglich gemacht, noch kopiert werden. Auf ihr Verlangen sind sie zurückzugeben.
- 2.6 Lichtplanungen, die auf Verlangen des Interessenten erstellt werden müssen, können verrechnet werden.
- 2.7 Einkaufsbedingungen des Bestellers oder Abänderungen dieser AGB sowie alle sonstigen Vereinbarungen sind für die Mabalux AG nur so weit verbindlich, als diese von ihr schriftlich anerkannt wurden.

3. Bestellungen

- 3.1 Durch Erteilung der Bestellung anerkennt der Besteller diese AGB.
- 3.2 Hat der Besteller eine Bestellung aufgegeben und hat die Mabalux AG diese bestätigt, können Abänderungen oder Annullierungen nur noch in beidseitigem Einverständnis erfolgen.
- 3.3 Spezialanfertigungen, zum Beispiel:
- alle Leuchtenfarben ausser (Standard) Weiss und Silber
 - Kelvintemperaturen (ausser 3000 Kelvin und 4000 Kelvin)
 - Leuchten mit integrierten Steuerungen und deren Bestandteilen
- sind von Abänderungen oder Annullierungen sowie deren Rückgaben ausgeschlossen. (Spezialanfertigungen müssen im Angebot oder der Auftragsbestätigung nicht deklariert werden.)

- 3.4. Auf Abruf bestellte Ware muss innert der festgelegten Abruffrist abgenommen werden. Wird diese Frist überschritten, besteht die Berechtigung zur Fakturierung sowie zur Verrechnung von Kapitalzinsen und Lagermiete.

4. Lieferfristen

- 4.1. Die Lieferfristen werden nach bestem Vermögen eingehalten. Die Mabalux AG kann jedoch für die Einhaltung von Lieferfristen und Terminen keine Gewähr übernehmen. Insbesondere kann es aufgrund von Verzögerungen durch den Kunden oder Dritte, wie z.B. bei verspäteten planerischen und/oder statischen und/oder anderen Freigaben, verspäteter Unterzeichnung terminrelevanter Nachträge, vom Kunden vorgeschlagener Änderungen des Verkaufsgegenstandes oder der Dienstleistung bzw. ganz generell aufgrund fehlender, ungenügender Vorbereitung oder Unterstützung durch den Kunden, Dritte oder aufgrund von neuen Erkenntnissen oder geltender Sicherheitsbestimmungen, zu Terminverschiebungen kommen, für welche die Mabalux AG nicht haftet. Ist eine Lieferfrist weder individuell vereinbart noch bei der Annahme der Bestellung angegeben worden und hat der Lieferant einen Liefertermin vielmehr unverbindlich in Aussicht gestellt, gilt dieser in Aussicht gestellte Termin nur annähernd.
- 4.2. Hält die Mabalux AG einen Liefertermin nicht ein, ist der Besteller berechtigt, dem Lieferanten eine angemessene Nachfrist zu setzen und für den Fall, dass diese erfolglos verstreicht, vom Vertrag zurückzutreten. Als angemessene Nachfrist gilt bei Standardprodukten eine Frist von fünf Wochen, bei Sonderanfertigungen von sieben Wochen.
- 4.3. Eventuelle Ersatzansprüche wegen Terminüberschreitung können nicht anerkannt werden.

5. Anlieferung

- 5.1. Die Mabalux AG bestimmt die Art des Versandes. Sie ist berechtigt, die Ware in Teillieferungen auszuliefern.
- 5.2. Versandkosten sind ab einem Auftragswert von 3'000 CHF netto frei Haus (innerhalb der Schweiz), bei Teillieferungen werden Transportkosten nach Aufwand verrechnet. Von dieser Bestimmung ausgeschlossen ist Sperrgut.
- 5.3. Sämtliche Lieferungen erfolgen an die angegebene Lieferadresse des Bestellers.
- 5.4. Alle Lieferungen erfolgen standardmässig entladebereit ohne Hebebühne, ebenerdig oder auf Rampe. Der Empfänger stellt die zum Ausladen notwendigen Personen und Transporthilfen auf seine Kosten zur Verfügung.
- 5.5. Es gilt die Unterschrift eines Arbeitnehmers des Empfängers als Bestätigung dafür, dass die Sendung vollständig und frei von sichtbaren Schäden ist. Wird die Lieferung nicht persönlich entgegengenommen gilt ein Arbeitstag als Frist für Beanstandungen. Die Ware reist auf Gefahr und Risiko des Empfängers.

6. Verpackung

- 6.1. Die Entsorgung von Verpackungsmaterial geht zu Lasten des Empfängers.

7. Mustersendungen

- 7.1. Ausnahmsweise werden Standardleuchten für Beleuchtungsproben, für höchstens 60 Tage, zur Verfügung gestellt. Innert dieser Zeit nicht retourniertes Material gilt als definitiv bezogen und wird verrechnet. In jedem Fall werden Leuchten verrechnet, die vom Empfänger abgeändert oder beschädigt wurden. (z.B. Ausbrechen oder Abändern von vorgestanzten Zuführungen i.a.)
- 7.2. Muster, die auf Verlangen des Interessenten besonders angefertigt werden müssen, werden verrechnet.

8. Rücksendungen

- 8.1. Rücksendungen werden nur nach vorheriger Vereinbarung und franko angenommen. Es werden nur originalverpackte Katalogprodukte zurückgenommen. In jedem Fall wird ein Unkostenbeitrag verrechnet. Beschädigtes Material wird nicht gutgeschrieben. Allfällige Instandstellungsarbeiten werden zu Selbstkosten verrechnet. fehlende Teile wie Leuchtmittel, Befestigungsmaterial, Originalverpackung usw. werden verrechnet.
- 8.2. Ware, deren Lieferung (Lieferschein der Mabalux AG) weiter als 6 Monate zurückliegt, oder eine neue Generation der Leuchte eingeführt wurde, kann nicht mehr zurückgenommen werden.
- 8.3. Spezialanfertigungen, abgeänderte Standardmodelle (Farbe oder Ausführung) sowie Leuchtmittel werden nicht zurückgenommen.

9. Masse und Konstruktionsänderungen

- 9.1. Von Abbildungen, Gewichtsen, Masstabellen oder sonstigen Angaben kann abgewichen werden, sofern sich dies als zweckmässig erweist.

10. Reklamationen

- 10.1. Minder- oder Falschlieferungen sowie Mängel können nur innerhalb von 10 Tagen nach Ankunft der Lieferung beanstandet werden. Der Kunde ist verpflichtet dies schriftlich anzuzeigen. Versäumt der Kunde dies, so gilt die Lieferung bzw. der Verkaufsgegenstand als genehmigt und vertragsgemäss erfüllt. Davon ausgeschlossen sind Mängel, die auch bei der sorgfältigen Untersuchung nicht erkennbar waren.
- 10.2. Transportschäden müssen unverzüglich bei der Mabalux AG angemeldet werden. Zu spät (1 Arbeitstag) beanstandete Transportschäden können nicht mehr bearbeitet werden. Die Verpackung muss zur Begutachtung bereitgehalten werden. Bei „ex-Werk“-Lieferungen sind Transportschäden beim Spediteur direkt anzumelden.

11. Garantie

- 11.1. Die Garantie für Leuchten beträgt fünf Jahre (Von der Garantie erfasst sind ausschliesslich Produkte auf Basis Technologie LED) nach erfolgter Lieferung und beschränkt sich während dieser Frist auf auftretende Mängel die nachweisbar auf Material-, Ausführungs- oder Konstruktionsfehler seitens der Mabalux AG zurückzuführen sind. Ausgenommen sind Verschleissteile wie konventionelle Leuchtmittel, Led-Retrofit Leuchtmittel oder Notlicht-Batterien. Bei LED-Leuchten sind die LED-Bestandteile der Garantie.
- 11.2. Grundvoraussetzung für eine Leistung aus der Garantie ist, dass das Produkt gemäss der Montageanleitung und den allgemein anerkannten technischen Regeln und Normen durch einen Fachhandwerker bei dem Garantiennehmer installiert und von dem Garantiennehmer bestimmungsgemäss und gemäss den Produktspezifikationen der Mabalux AG und dessen Zulieferer verwendet worden ist.
- 11.3. Von der Garantie sind insbesondere nicht erfasst:
- Veränderungen, Verfärbungen oder Versprödungen von Kunststoffbauteilen des Produktes, die sich aufgrund natürlicher Alterungsprozesse, insbesondere bei Bauteilen aus Polycarbonat, ergeben
 - Einstellungen bzw. Parametrierungen von Beleuchtungsanlagen
 - Fehler oder Schäden am Produkt, die vom Garantiennehmer selbst oder durch von ihm eigenmächtig beauftragte Dritte herbeigeführt wurden, z.B. im Falle von unsachgemässer Installation und/oder Reparaturversuchen
 - Fehler oder Schäden am Produkt, die durch Überschreiten der Grenzwerte hinsichtlich der Umgebungstemperatur, der Netzspannung oder durch Überschreiten sonstiger in den Produktspezifikationen angegebener Grenzwerte entstehen
 - wenn Mängel als Folge von Softwareviren und Malware festgestellt werden

Produktausfälle oder Lichtstromrückgänge in folgendem Umfang:

- Produktausfälle (Mortalität): Mittlere Nennausfallrate bis zu 0,2% / 1'000 Betriebsstunden
- Bestromung Low Power: Lichtstromrückgang bis zu 0,2% / 1'000 Betriebsstunden
- Bestromung Medium Power: Lichtstromrückgang bis zu 0,3% / 1'000 Betriebsstunden
- Bestromung High Power: Lichtstromrückgang bis zu 0,6% / 1'000 Betriebsstunden

Toleranzen von:

- +/- 150K in der Farbtemperatur von LED-Modulen
- bis zu +10% Leistungsaufnahme in LED-Betriebsgeräten und +/- 10% gegenüber kommunizierten Lichtstromwerten

- 11.4. Die elektro- und wärmespezifischen Grenzwerte dürfen nicht überschritten werden. Die Mindestdistanzierungen gemäss Datenblättern müssen eingehalten werden. Tritt ein Garantiefall ein, so liegt es im Ermessen der Mabalux AG, das mangelhafte Produkt zu reparieren, durch ein gleichwertiges Produkt auszutauschen oder eine Preisminderung zu gewähren.
- 11.5. Bei Ersatz von defekten Leuchten oder Komponenten beginnt die Garantiedauer weder für die Ersatzleuchte noch für die Ersatzkomponenten neu zu laufen.

- 11.6 Jede weitere Garantie- oder Schadenersatzleistung ist ausgeschlossen. Insbesondere werden keine Kosten für die Demontage und Wiedermontage von Leuchten, Transport, Programmierung, Softwareupdates oder deren Bestandteile sowie für irgendwelche andere Folgeschäden übernommen.
- 11.7 Bei der Geltendmachung eines Garantiefalls hat der Garantiennehmer die Herkunft des Produktes sowie das Datum der ersten Inrechnungstellung, der Mabalux AG, durch Vorlage des Lieferscheins, der Rechnung, o.ä. zu belegen.
- 11.8 Von der Garantie ausgeschlossen sind auch Leuchten und Apparate, welche nach Konstruktionen oder Modellen des Bestellers hergestellt werden, sofern Schäden auf Konstruktionsfehler zurückzuführen sind.
- 11.9 Jegliche Garantie setzt im Übrigen voraus, dass das defekte Material verpackt, franko, an Mabalux AG, Dulliken zugestellt wird.
- 11.10 Erfolgt die Garantieleistung als Ersatzlieferung eines gleichen oder gleichwertigen Produktes sind Abweichungen von dem ursprünglichen Produkt aufgrund technischen Fortschritts sowie vertretbare und geringfügige Abweichungen hinsichtlich des Designs und/oder der Eigenschaften – auch lichttechnisch – des Produktes vorbehalten.
- 11.11 Im Rahmen der Reparatur eines Produktes kann die Mabalux AG neue oder wiederverwertete Materialien (voll funktionsfähig und geprüft) als Ersatzteile einsetzen. Während der Dauer der Reparatur, wird die Mabalux AG dem Garantiennehmer kein Ersatzprodukt bereitstellen.
- 11.12 Im Rahmen dieser Garantie bestehen keine Ansprüche auf Schadenersatz oder Ersatz vergeblicher Aufwendungen. Die Mabalux AG ersetzt im Rahmen dieser Garantie insbesondere keine Nutzungsausfallschäden, Folgeschäden oder Schäden wegen entgangenen Gewinns, noch ersetzt die Mabalux AG im Rahmen dieser Garantie Kosten für z.B. den Ein- und/oder Ausbau der Produkte (inklusive Kosten für Gerüst- und Hebevorrichtungen), Montage-, Lagerungs-, Transport- und/oder Versandkosten (sofern nicht anders in diesen Garantiebedingungen vorgesehen), Kosten für die Entsorgung eines fehlerhaften Produktes (sofern dieses nicht von der Mabalux AG zurückgenommen wurde), Kosten für die Parametrierung und/oder Inbetriebnahme von Beleuchtungsanlagen und Leuchten, Kosten für Updates der Software eines Produktes etc.
- 11.13 Im Falle einer unberechtigten Geltendmachung eines Garantiefalls hat der Garantiennehmer die Aufwendungen der Mabalux AG zur Prüfung des Produktes, einschliesslich etwaiger übernommener Kosten für den Hin- und Rücktransport, zu ersetzen, es sei denn, das Nichtvorliegen der Fehlerhaftigkeit war für den Garantiennehmer nicht erkennbar.
- 11.14 Die Veräusserung des Produktes führt nicht zu einem Neubeginn oder zu einer Verlängerung der Garantiezeit.
- 11.15 Wird das unter diese Garantie fallende Produkt vom Garantiennehmer an einen nachfolgenden Erwerber veräussert, so tritt dieser an die Stelle des ursprünglichen Garantiennehmers, vorausgesetzt der Erwerber erfüllt die in der Ziffer 1 genannten Voraussetzungen im Hinblick auf den sachlichen, persönlichen und räumlichen Geltungsbereich dieser Garantie. Die Garantie gilt für diesen, an die Stelle des vorherigen Garantiennehmers tretenden, Garantiennehmer im Umfang und unter den Voraussetzungen, die in diesen Garantiebedingungen vorgesehen sind. Den neuen Garantiennehmer trifft insbesondere auch die Pflicht zur Vorlage des Herkunftsnachweises und zum Nachweis des Bestehens der Garantiezeit.
- 11.16 Von der Garantie erfasst sind ausschliesslich Produkte, welche von der Mabalux AG in Rechnung gestellt wurden und die Rechnung beglichen wurde, die von dem Garantiennehmer in der Schweiz verwendet werden.

12. Eigentumsvorbehalt

- 12.1 Gelieferte Ware bleibt bis zur vollständigen Bezahlung Eigentum der Mabalux AG. Der Käufer erklärt hiermit sein Einverständnis zur Eintragung des Eigentumsvorbehaltes an seinem Wohnsitz.
- 12.2 Der Käufer trifft geeignete Massnahmen, damit der Eigentumsanspruch der Mabalux AG weder beeinträchtigt noch aufgehoben wird.

13. Zahlungsbedingungen

- 13.1 Rechnungen sind innert 30 Tagen ohne jeden Abzug zahlbar. Andere Zahlungsbedingungen sind schriftlich zu vereinbaren.
- 13.2 Soweit der Kunde zur Vorleistung und/oder zur Leistung von Akontozahlungen verpflichtet ist, ist die Mabalux AG erst nach vollständigem Zahlungseingang zur Leistungserbringung verpflichtet.

- 13.3. Allfällige Beanstandungen von Rechnungen sind innerhalb von 14 Kalendertagen ab Rechnungseingang schriftlich anzubringen, andernfalls gelten Rechnungen als anerkannt.

14. Nebenabreden

- 14.1. Andere Vereinbarungen als diese AGB sowie Nebenabreden gelten nur, wenn sie schriftlich vereinbart sind.

15. Submissionen

- 15.1. Die AGB der Mabalux AG gehen, wenn sie in Widerspruch mit Submissionsbestimmungen stehen, diesen vor.

16. Erfüllungsort und Gerichtsstand

- 16.1. Ausschliesslicher Erfüllungsort für den Käufer und für die Mabalux AG ist Dulliken (Schweiz) und zwar auch dann, wenn Lieferungen franko vereinbart sind.
- 16.2. Gerichtsstand ist Dulliken (Schweiz). Die Mabalux AG behält sich jedoch vor, den Vertragspartner nach ihrer Wahl auch an dessen Wohnsitz/Sitz oder einem anderen zuständigen Gericht zu belangen.

17. Anwendbares Recht

- 17.1. Die Rechtsbeziehung mit der Mabalux AG untersteht schweizerischem Recht. Soweit die vorliegenden AGB keine speziellen Regelungen enthalten, gelten die Bestimmungen des schweizerischen Obligationenrechts. Sollten einzelne Bestimmungen dieser AGB unwirksam sein oder werden, so sind die übrigen Bestimmungen hiervon nicht berührt.

18. Haftung und Haftungsausschluss

- 18.1. Die Haftung der Mabalux AG, gleich aus welchem Rechtsgrund, insbesondere aus Vertrag, unerlaubter Handlung oder ungerechtfertigter Bereicherung, in allen Fällen inklusive der Haftung für Hilfspersonen, wird soweit gesetzlich zulässig wegbedungen.
- 18.2. Insbesondere haftet die Mabalux AG nicht für mittelbare oder indirekte Schäden (inklusive Schäden als Folge von Ereignissen der Cyber-Sicherheit, wie z. B. durch Softwareviren, Malware und Hacking verursachte Schäden), Folgeschäden, entgangenem Gewinn, entgangenem Umsatz, entgangene Einsparungen, Verzugsschäden oder Schäden im Zusammenhang mit der Gewährleistung oder Garantie.
- 18.3. Sollten die Bestimmungen von Ziffer 18.1 und/oder Ziffer 18.2 unwirksam sein, so ist die Haftung der Mabalux AG in der Summe für sämtliche Ereignisse auf 50% des durch den Kunden für die betreffende Lieferung bzw. Dienstleistung bezahlten oder zu bezahlenden Preises, exklusive Mehrwertsteuer, beschränkt.
- 18.4. Der Lieferant haftet nicht für Schäden, die durch unsachgemässe Einwirkung Dritter, unsachgemässe Montage, Überbeanspruchung, Überspannung oder chemische Einflüsse entstehen, sofern diese nicht auf ein Verschulden des Lieferanten oder seiner Vertreter zurückzuführen sind. Gleiches gilt bei eigenmächtigen und unsachgemässen Reparaturen oder Eingriffen in den Liefergegenstand durch den Besteller oder Dritte.

19. Verschiedenes

- 19.1. Erklärungen, die den Nachweis durch Text ermöglichen, insbesondere E-Mail, gelten als schriftliche Erklärungen einer Partei. Solche Erklärungen gelten im Zeitpunkt des Abrufs durch den Empfänger als zugegangen und zur Kenntnis genommen.
- 19.2. Dem Kunden ist die Abtretung von Forderungen aus oder in Zusammenhang mit dem Vertrag mit der Mabalux AG untersagt. Jede Abtretung und Verletzung der vorangehenden Bestimmung ist nichtig. Die Mabalux AG darf Forderungen aus oder in Zusammenhang mit dem Vertrag an Dritte abtreten.
- 19.3. Die Zurückbehaltung von Zahlungen des Bestellers sind ausgeschlossen.
- 19.4. Der Kunde darf Forderungen der Mabalux AG nicht mit Gegenforderungen des Kunden verrechnen. Der Mabalux AG ist die Verrechnung von Forderungen des Kunden mit Gegenforderungen der Mabalux AG gestattet.
- 19.5. Folgende Informationen zur Lebensdauer von Leuchten sind zu beachten:
- Die Lebensdauer aller lichttechnischen Produkte ist von der Einhaltung der in den technischen Daten angegebenen Standard-Betriebsbedingungen abhängig

- Leuchten sind Verschleisssteile, deren jeweilige Lebensdauer sehr unterschiedlich ist (1'000 bis 60'000 Stunden) und von den Betriebsbedingungen stark beeinflusst werden kann
 - Die Angabe der Lebensdauer einer Leuchte geschieht üblicherweise in Form von Betriebsstunden (z.B. mittlere Lebensdauer = 50'000 Stunden) und wird unter genormten Bedingungen ermittelt, die von der Praxis abweichen können
 - Wird die Lebensdauer in Form von Betriebsjahren angegeben, basiert dies ebenfalls ausschliesslich auf angenommenen Standardbetriebsbedingungen (Schaltzyklen, Betriebsstunden pro Jahr usw.) und den üblichen Kriterien für Wartungsintervalle, die für den angesprochenen Einsatzzweck sinnvoll erscheinen
- Im Übrigen wird auf die produktspezifischen Angaben in den Produktdatenblättern und Montageanleitungen von Mabalux AG und deren Zulieferer verwiesen.

19.6. Chargenunterschiede im Sinne material- und oberflächenbedingt unvermeidbarer Verfahrenstoleranzen sowie produkttypische Eigenschaften, welche lediglich ein geringfügiges optisches Beanstandungskriterium darstellen, bedeuten keinen Mangel. Grenzmuster für Abgleich werden auf Anfrage des Bestellers im Vorfeld eines Vertrages zur Verfügung gestellt. Zur Erläuterung material- und oberflächenbedingt unvermeidbarer Verfahrenstoleranzen – beispielsweise für Oberflächenausführung 'natureloxiertes Aluminium' – verweist der Lieferant auf das Merkblatt A 03 Farbtoleranzen bei der dekorativen Anodisation des VOA Verband für die Oberflächenveredelung von Aluminium e.V. (www.voa.de).

20. Vorgezogene Recycling-Gebühr (vRG)

- 20.1. Die Verordnung über die Rücknahme, die Rückgabe und die Entsorgung elektrischer und elektronischer Geräte (VREG) wurde um die Gerätekategorien Leuchtmittel und Leuchten ergänzt. Aus diesem Grund erheben Hersteller und Importeure von Leuchtmitteln und Leuchten ab 1. August 2005 einen Entsorgungsbeitrag zur Finanzierung der Rücknahme und Entsorgung dieser Geräte. Der vorgezogene Entsorgungsbeitrag (VEB) wird in der Folge als vRG als eingebürgerter Begriff bezeichnet.
- 20.2. Die Tarife und Gerätelisten sind bei der Stiftung Licht Recycling Schweiz SLRS erhältlich respektive unter www.slrs.ch einzusehen. Leuchtmittel sind mit einem einheitlichen Betrag (eine Tarifstufe) belegt.
- 20.3. Preisanpassungen infolge Tarifänderungen sind vorbehalten.

24. Änderungen der AGB

- 24.1 Die Mabalux AG behält sich eine jederzeitige Änderung dieser AGB vor. Änderungen gelten ab deren Publikation auf der Website der Mabalux AG (mabalux.ch) und gelten für alle danach begründeten Rechtsbeziehungen zwischen der Mabalux AG und dem Kunden.

Index

Stromschiene Track	2	Cubic Ambient A7 Wall	45
Midpin C2/C3 48V Track	4	Matric Ambient AX System 40mm Wall	45
Midpoint C6 3-Phase Track	5	Matric WX System 40mm Wall	46
Midpoint C7 3-Phase DALI Track	5	Matric DX System 40mm Wall	47
Basic Déco C3 3-Phase Track	6	Matric JX System 40mm Wall	47
Liquid Line Compact C5 3-Phase Track	7	Matric W4 System 55mm Wall	48
Liquid Line CX System 40mm 3-Phase Track	7	Matric W6 System 81mm Wall	49
Cubic Evolution C4 3-Phase Track	8		
Matric Déco C9 System 55mm 3-Phase Track	9	Pendel Suspended	52
3-Phase Track	10	Midpin G3 Single Suspended	54
		Midpoint P7/P8 Suspended	54
Tisch Table	11	Basic Superflat G7/P7 Suspended	55
Lucille T1 Table	12	Basic Neo G5/P5 Suspended	56
Beam Me Up T1 Mini Table Office	12	Basic Déco G3/P3 Suspended	57
Beam Me Up T2 Mini Table Home	13	Basic Déco XXL G4/P4 Suspended	58
Cubic Evolution T2/T3 Table	14	Basic Déco O3 Suspended	60
Liquid Line TY System 40mm Table Symmetric	14	Basic Max G1/P1 Suspended	60
Liquid Line TX System 40mm Table Asymmetric	15	Basic Visio G9/P9 Suspended	62
		Beam Me Up (Flat) G3/P3 Suspended	63
		Beam Me Up (Max) G1/P1 Suspended	64
Steh Floor	16	Ringo Star Compact G5/P5 Suspended	65
Grand Lucille S9 Floor	18	Ringo Star GY/PY System 40mm Suspended	66
Lucille S1 Floor	18	Ringo Star GX/PX System 40mm Suspended	67
Basic Neo S2 Floor	19	Ringo Star Acoustic GY/PY System 40mm Suspended	68
Basic Neo S4 Floor	19	Ringo Star G3/P3 System 60mm Suspended	69
Basic Déco S3 Floor	20	Ringo Star Acoustic G3/P3 System 60mm Suspended	70
Basic Déco S5 Floor	20	Ringo Star G1/P1 System 100mm Suspended	72
Beam Me Up S1 Mini Floor	21	Ringo Star Acoustic G1/P1 System 100mm Suspended	74
Beam Me Up S4 Floor	21	Ringo Star Chandelier G1/P1 Suspended	75
Beam Me Up S6 Floor	22	Ringo Star Cluster G3/P3 Suspended	78
Liquid Line SX System 40mm Floor One Head	23	Ringo Star Chain G3/P3 Suspended	79
Liquid Line SY System 40mm Floor Two Heads	23	Ringo Star Oblong GX/PX Suspended	80
Caleo Neo S2 Floor	24	Liquid Line Compact G5/P5 Suspended	81
Caleo Neo S4 Floor	24	Liquid Line GX/PX System 40mm Suspended	82
Cubic Evolution F1 Floor	25	Liquid Line G3/P3 System 60mm Suspended	84
Cubic Evolution F2 Floor	26	Code Zero G3/P3 Suspended	86
Cubic Evolution F3 Floor	26	Caleo Inverse GX/PX System 40mm Suspended	87
Cubic Evolution F5/F6 Floor	27	Caleo Neo G4/P4 Suspended	88
Cubic Evolution F7 Floor	28	Caleo Neo G6/P6 Suspended	89
Cubic Evolution F8 Floor	28	Cubic Evolution G4/P4 200mm Suspended	90
Matric SX System 40mm Floor One Head	29	Cubic Evolution G5/P5 300mm Suspended	91
Matric SY System 40 mm Floor Two Heads	29	Cubic Evolution G6/P6 Square Suspended	92
		Cubic Evolution G4/P4 System Suspended	93
		Cubic Evolution U4 Suspended	94
Wand Wall	32	Cubic Max G2/P2 Suspended	95
Lucille W1 Wall	34	Cubic Ambient G7/P7 Suspended	96
Midpin W2 Wall	34	Cubic Déco G3/P3 Suspended	97
Midpoint W7 Wall	35	Matric Déco G9/R9 Suspended	98
Basic Superflat X7/Y7 Wall	35	Matric RY System 40mm Suspended	100
Basic Neo W5 Wall	36	Matric GX/RX System 40mm Suspended	100
Basic Neo Y5/X5 Wall	37	Matric G3/R3 System 55mm Suspended	103
Basic Déco Y3/X3 Wall	38	Matric R4 System 55mm Suspended	105
Basic Visio Y9/X9 Wall	39	Matric G5 System 81mm Suspended	107
Liquid Line Compact W5 Wall	40	Matric G6/R6 System 81mm Suspended	111
Liquid Line WX System 40mm Wall	40	Matric Square GX/RX System 40mm Suspended	113
Caleo Neo Y6/X6 Wall	41	Matric Square Acoustic GX/RX System 40mm Suspended	114
Cubic Evolution W4 Wall	42	Vision Gen. 4 G4/P4 Suspended	117
Cubic Evolution Y6/X6 Wall	43	Plank G4/P4 Suspended	
Cubic Déco A3 Wall	44		

Anbau Surface	118	Einbau Recessed	164
Midpoint B7 Surface	120	Midpin M2 Recessed	166
Midpoint A6 Surface	120	Midpoint E6 Semi-Recessed	166
Basic Superflat Y7/X7 Surface	121	Midpoint F7 Recessed	167
Basic Neo A5 Surface	122	Midpoint M6 Recessed	168
Basic Neo X5 Surface	123	Basic Superflat L7 Semi-Recessed	169
Basic Déco A3/A4 Surface	124	Basic Déco N3 Recessed Frameless	169
Basic Déco X3 Surface	125	Basic Déco L3 Recessed Frame	170
Basic Déco Z3 Surface	126	Basic Max M2 Recessed Frameless	171
Basic Max A1 Surface	127	Basic Max M4 Recessed Frame	172
Basic Max Y1/X1 Surface	128	Basic Visio L9 Semi-Recessed	173
Basic Visio Y9/X9 Surface	129	Ringo Star Compact F5 Recessed Frame	173
Beam Me Up (Flat) Y3/X3 Surface	130	Ringo Star FX System 40mm Recessed Frame	174
Beam Me Up (Max) Y1/X1 Surface	131	Ringo Star F1 System 100mm Recessed Frame	175
Beam Me Up (Wallwasher) A4 Surface	132	Liquid Line Compact F5 Recessed Frame	176
Ringo Star Compact A5 Surface	133	Liquid Line QX/FX System 40mm Recessed	177
Ringo Star AX System 40mm Surface	133	Liquid Line F3 System 60mm Recessed	179
Ringo Star A3 System 60mm Surface	134	Caleo Max M2 Recessed Frameless	180
Ringo Star A1 System 100mm Surface	136	Cubic Max M2 Recessed Frameless	181
Liquid Line Compact A5 Surface	137	Cubic Max M4 Recessed Frame	181
Liquid Line AX System 40mm Surface	138	Cubic Ambient M7 Recessed Frame	182
Liquid Line A3 System 60mm Surface	139	Cubic Déco L3 Recessed Frame	183
Caleo Inverse AX System 40mm Surface	141	Matric Déco M9 Recessed Frameless	183
Caleo Neo Y4/X4 200mm Surface	141	Matric Déco F9 Recessed Frame	185
Caleo Neo Y6/X6 Square Surface	142	Matric MX System 40mm Recessed Frameless	186
Cubic Evolution Y4/X4 200mm Surface	143	Matric FX System 40mm Recessed Frame	188
Cubic Evolution Y5/X5 300mm Surface	144	Matric M3 System 55mm Recessed Frameless	189
Cubic Evolution Y6/X6 Square Surface	145	Matric F3 System 55mm Recessed Frame	191
Cubic Neo A9 Surface	146	Matric M5 System 81mm Recessed Frameless	193
Cubic Max A2/X2 Surface	147	Matric F5 System 81mm Recessed Frame	195
Cubic Ambient A7 Surface	148		
Cubic Déco A3 Surface	149	Höhere Schutzart Higher Protection	198
Matric Déco A9 Surface	150	Basic Max A1 IP54 Surface	200
Matric AY System 40mm Surface	151	Matric AX IP54 System 40mm Surface	200
Matric XY System 40mm Surface	152	Matric A3 IP54 System 55mm Surface	201
Matric AX System 40mm Surface	153	Matric FX IP54 System 40mm Recessed Frame	202
Matric A3 System 55mm Surface	155	Matric F3 IP54 System 55mm Recessed Frame	202
Matric A5 System 81mm Surface	157		
Matric A6 System 81mm Surface	158	Appendix	204
Vision Gen. 4 A4/X4 Surface	160	Suspensions	205
Plank Y4/X4 Surface	163	Surface Design	206
		Colour Temperature	208
		Colour Rendering	209
		Multisensor	210
		Radar Sensor	211
		Swarm Control	212
		HCL-Control	213
		Emergency Light	214
		Garantiebedingungen / Terms of Warranty	215/216
		Verkaufs- und Lieferbedingungen /	
		Conditions of Sale and Delivery	218/221
		Legal Notes	227

mabalux
Lichttechnik

Mabalux AG

Bahnhofstrasse 11

4657 Dulliken

info@mabalux.ch

+41 62 295 01 47